

3M-Series

Miniature Pushbutton Switches

PRODUCT WEBPAGE

request sample, configure part

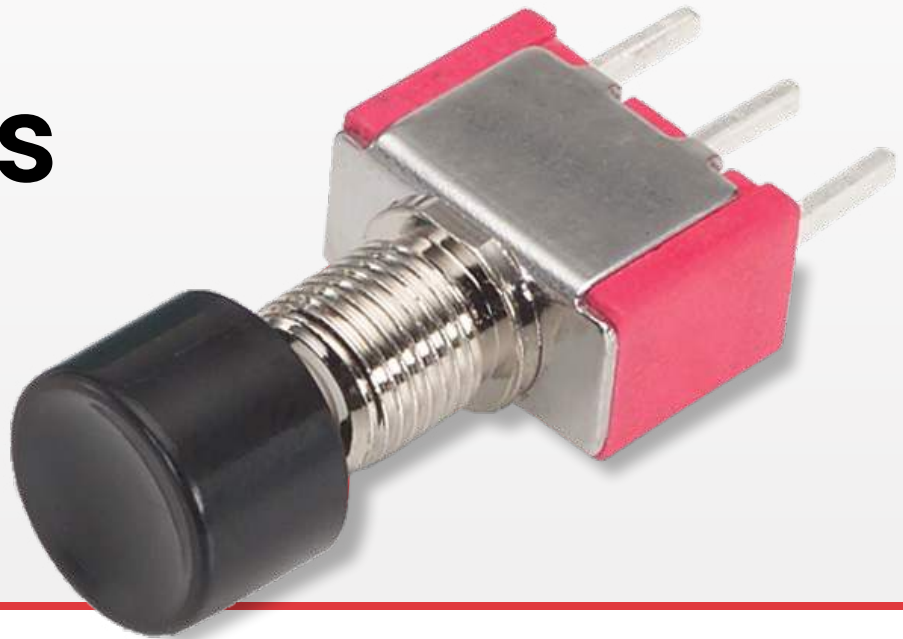

The 3M family of miniature pushbutton switches is composed of four switch series; the 3MNH-Series premium sealed snap-action pushbutton, the 3MN-Series snap-action pushbutton, the 3MS-Series sealed snap-action pushbutton, and the 3MA-Series alternate-action pushbutton. These PC mount pushbutton switches offer a variety of ratings, circuits, contact materials, terminal platings, pushbutton styles, and optional color caps.

1-2 **.4-6** **125, 250** **28**
 Poles Amps VAC VDC

Typical Applications

- Instrumentation
- Telecommunications
- Networking
- Performance Audio
- Computers
- Low Power On/Off Designs

Tech Specs



3MNH-Series
Premium Sealed
Miniature Pushbutton Switch



3MS-Series
Sealed Snap-Action
Miniature Pushbutton Switch



3MN-Series
Snap-Action
Miniature Pushbutton Switch



3MA-Series
Alternate Action
Miniature Pushbutton Switch

Electrical

Contact Rating	refer to ordering scheme
Electrical Life	50,000 make & break cycles @ full load
Contact Resistance	3MS-Series: 50 mΩ max. initial @ 2-4 VDC 100mA for both silver & gold plated contacts. 3MN, 3MA & 3NMH-Series: 10 mΩ max. initial @ 2-4 VDC 100mA for both silver & gold plated contacts.
Insulation Resistance	1000 MΩ min.
Dielectric Strength	1500 Volts RMS @ sea level

Physical

Operating Temperature	-30°C to +85°C
Index of Protection	3MS-Series: IP68 3MNH-Series: IP67
Cap Installation Support	3MS-Series: 10 lbs. max.
Solder Heat Resistance	MIL-STD-202, Method 210

Material

Case	3MS-Series: Glass filled nylon 6/6, flame retardant, heat stabilized (UL94V-0) 3MN, 3MA & 3NMH-Series: Diallyl phthalate (DAP) (UL 94V-0)
Plunger	3MS & 3MA-Series: Glass filled nylon or glass filled polyester (UL94V-0) 3MN-Series: Thermoplastic polyester, black 3NMH-Series: Brass, black finish with o-ring seal
Bushing	3MN-Series: Brass, nickel plated 3MA-Series: Zinc, nickel plated 3NMH-Series: Brass, black finish with o-ring seal
Housing	3MN & 3MA-Series: Stainless Steel
Switch Support	3MS-Series: Stainless Steel
Terminal Seal	Epoxy

Ordering Schemes

Sample Part Number 3MNH - DP 1 - PJ - BJ - M2 - Q E

Selection 1 2 3 4 5 6 7 8

1. SERIES

3MNH Premium Sealed Miniature Pushbutton Switch

2. POLES

SP Single pole - uses terminals 1, 2 & 3
DP Double pole - uses terminals 1, 2, 3, 4, 5 & 6

3. CIRCUIT

() - momentary
Switching Position: 1 2
 1 ON ON
 7 ON (ON)

Note: Plunger at rest in Position 1. Plunger depressed in Position 2.

4. ACTUATOR STYLE

PJ .325 height [8.25 mm]
PA .157 height [4.00 mm]
PB .354 height [9.00 mm]

Notes:

- PJ Plunger for maintained circuits only. PA and PB Plunger for momentary circuits only
- Hardware includes (1) 2MI-HDW4 nut and (1) 3MNH-WCP-0872 o-ring
- BJ Bushing only available with PJ Plunger
- BL Bushing only available with PA or PB Plunger
- Movable contact & terminal platings: silver over copper alloy
- Movable Contact platings: gold over nickel over copper alloy
- Terminal platings: gold over nickel over copper alloy

[Configure Complete Part Number >](#)

[Browse Standard Parts >](#)



5. ACTUATOR COLOR

BJ³ Threaded 15/32, flat, .553 height [14.05 mm]
BL⁴ Threaded 15/32, flat, .295 height [7.49 mm]

6. TERMINATION

M1 Solder Lug
M2 PC thru-hole
M51 Wire wrap, .71" [18.05 mm]
M52 Wire wrap, .924" [23.48 mm]
M53 Wire wrap, .386" [9.80 mm]

7. CONTACTS / TERMINALS

Contact Material	Terminal Plating	Rating	Approvals
G silver ⁵	gold over silver (SP1, DP1) (SP7, DP7)	6A@125VAC or 28VDC 3A@250VAC 1A@120VAC or 38VDC	 us, IP67
Q silver ⁵	silver ⁵ (SP1, DP1) (SP7, DP7)	6A@125VAC or 28VDC 3A@250VAC 1A@120VAC or 38VDC	 us, IP67
R gold ⁶	gold ⁷	0.4VA max @ 20V max (AC/DC)	N/A

8. EPOXY SEAL

E Epoxy Seal

Sample Part Number 3SM - WSP 7 - P1 - B1 - M6 Q E

Selection 1 2 3 4 5 6 7 8

1. SERIES

3MS Sealed Snap-Action Miniature Pushbutton Switch

2. POLES

WSP Single pole - uses terminals 1, 2 & 3
WDP Double pole - uses terminals 1, 2, 3, 4, 5 & 6

3. CIRCUIT

() - momentary
Switching Position: 1 2
 7 2-3, 5-6 2-1, 5-4
 ON (ON)

Note: Plunger at rest in Position 1. Plunger depressed in Position 2.

4. ACTUATOR STYLE

P1 Standard Plunger
P2 Long Plunger
P3 Short Plunger

5. BUSHING

B1¹ Threaded, with keyway, .350 height [8.89 mm]
B4 Unthreaded, flatted, .250 height [6.35 mm]



Notes:

- Hardware includes (2) 2MI-HDW2 nuts, (1) 2MI-HDW11 washer, and (1) 2MI-HDW15 locking ring
- Movable contact and terminal platings: gold over nickel over copper alloy
- Movable contact and terminal platings: silver over copper alloy

6. TERMINATION

M1 Solder Lug
M2 PCB
M6 PC Mount, 90° horizontal
M61 Snap-In, 90° horizontal
M7 PC Mount, 90° vertical
M71 Snap-In, 90° vertical
VS2 PC Mount, U bracket, .620" mounting x .461" height
VS21 Snap-In, U bracket, .620" mounting x .461" height
VS3 PC Mount, U bracket, .620" mounting x .630" height
VS31 Snap-In, vertical, .630" height
VS4 PC Mount, U bracket, .750" mounting x .461" height
VS41 Snap-In, vertical, .461" height
VS5 PC Mount, U bracket, .750" mounting x .630" height
VS51 Snap-In, vertical, .630" height

7. CONTACTS / TERMINALS

Contact Material	Terminal Plating	Rating	Approvals
G silver ³	gold over silver	1A 120VAC or 38VDC	 us, IP68
Q silver ³	silver ³	1A 120VAC or 38VDC	 us, IP68
R gold ²	gold ²	0.4VA max 20V max (AC/DC)	IP68

8. EPOXY SEAL

E Epoxy Seal **0** without Epoxy Seal

[Configure Complete Part Number >](#)

[Browse Standard Parts >](#)

Ordering Scheme

3MN-Series with Square Actuator

Sample Part Number 3MN - SP - 7 - AP2 / 3 2 - M6 Q E

Selection 1 2 3 4 5A 5B 6 7 8

3MN-Series with Plunger Actuator

Sample Part Number 3MN - SP - 7 - P2 - B10 - B6 Q E

Selection 1 2 3 4 5 6 7 8

1. SERIES

3MN Snap-Action Miniature Pushbutton Switch

2. POLES

SP Single pole - uses terminals 1, 2 & 3
DP Double pole - uses terminals 1, 2, 3, 4, 5 & 6

3. CIRCUIT

() - momentary
Switching Position: 1 2
 7 2-3, 5-6 2-1, 5-4
 ON ON

Note: Plunger at rest in Position 1. Plunger depressed in Position 2.

4. ACTUATOR

Square Actuator (use with Color Options in Selection 5A & 5B)

AP1 Square with no frame
AP2 Square raised above frame
AP3 Square flush with frame

Plunger Actuator (use with Bushing Options in Selection 5)

P0 Flush Plunger
P1 Standard Plunger
P2 Short Plunger

5A. ACTUATOR COLOR & 5B FRAME COLOR

1 White
 2 Black
 3 Red

5B. BUSHING

B6 Unthreaded (for terminations VS6-VS9 only)
B10¹ Threaded keyway
B11² Threaded with flat
B20 Unthreaded keyway
B21 Unthreaded with flat

6. TERMINATION

M1 Solder Lug
M2 PCB
M51 Wire Wrap .750 [19.05]
M52 Wire Wrap .964 [24.40]
M53 Wire Wrap .425 [10.80]
M6 PC Mount, 90° horizontal
M7 PC Mount, 90° vertical
VS2 PC Mount, U bracket, .620" mounting x .461" height
VS3 PC Mount, U bracket, .620" mounting x .630" height
VS4 PC Mount, U bracket, .750" mounting x .461" height
VS5 PC Mount, U bracket, .750" mounting x .630" height
VS6 PC Mount, U bracket, .461" height (for B6 bushing only)
VS7 PC Mount, U bracket, .630" height (for B6 bushing only)
VS8 PC Mount, U bracket, .461" height (for B6 bushing only)
VS9 PC Mount, U bracket, .630" height (for B6 bushing only)

7. CONTACTS/TERMINALS

Contact Material	Terminal Plating	Rating	Approvals
G silver	gold over silver	1A 125VAC or 28VDC	c us
Q silver ⁵	silver ⁵	1A 125VAC or 28VDC	c us
R gold ⁶	gold ⁶	0.4VA max 20V max (AC/DC)	N/A

8. EPOXY SEAL

E Epoxy Seal **0** without Epoxy Seal

Notes:

- Hardware includes (2) 2M1-HDW2 nuts, (1) 2M1-HDW11 washer, and (1) 2M1-HDW15 locking ring
- Hardware includes (2) 2M1-HDW2 nuts, (1) 2M1-HDW11 washer, and (1) 2M1-HDW16 locking ring
- Selection 5B is blank if actuator style is AP1 (no frame)
- Black, white and red are standard. Other colors available, consult factory for details.
- Movable contact & terminal platings: silver over copper alloy
- Movable contact & terminal platings: gold over nickel over copper alloy

[Configure Complete Part Number >](#)

[Browse Standard Parts >](#)

Ordering Scheme

3MA-Series with Square Actuator

Sample Part Number 3MA - SP - 1 - AP2 / 3 2 - M6 Q E

Selection 1 2 3 4 5A 5B 6 7 8

3MN-Series with Plunger Actuator

Sample Part Number 3MA - SP - 1 - PD - BD - M6 Q E

Selection 1 2 3 4 5 6 7 8

1. SERIES

3MA Alternate Action Miniature Pushbutton Switch

2. POLES

SP Single pole - uses terminals 1, 2 & 3
DP Double pole uses terminals 1, 2, 3, 4, 5 & 6
3P¹ Three pole uses terminals 1, 2, 3, 4, 5, 6, 7, 8 & 9
4P¹ Four pole uses terminals 1, 2, 3, 4, 5, 6, 7, 8, 9, 10, 11, 12

3. CIRCUIT

() - momentary
Switching 1 **2** **3**
Position: 2-3, 5-6, 8-9, 11-12 Connected Terminals 2-1, 5-4, 8-7, 11-10
1 ON NONE ON
2* ON NONE (ON)

*Available in SP & DP only.

4. ACTUATOR

Square Actuator (use with Color Options in Selection 5A & 5B)
AP1 Square with no frame
AP2 Square raised above frame
Plunger Actuator (use with Bushing Options in Selection 5)
PA Standard Plunger
PI Medium Plunger
PL Brass Chrome Plunger
PC Brass Chrome Plated Plunger with Cap (for BD bushing only)
PD Brass Chrome Plated Plunger (for BD bushing only)

5A. ACTUATOR COLOR & 5B FRAME COLOR

1 White	4 Orange	7 Blue
2 Black	5 Yellow	8 Brown
3 Red	6 Green	9 Gray



5B. BUSHING

BD¹ Big bushing for PC, PD actuator 15/32"
B10² Threaded 1/4 - 40
B20 Unthreaded
B21 Unthreaded with flat

6. TERMINATION

M1 Solder Lug
M2 PCB
M51 Wire Wrap .750
M52 Wire Wrap .964
M53 Wire Wrap .425
M54 Wire Wrap 1.062
M6 PC Mount, 90° horizontal
M7 PC Mount, 90° vertical
VS2 PC Mount, U bracket, .620" mounting x .461" height
VS3 PC Mount, U bracket, .620" mounting x .630" height
VS4 PC Mount, U bracket, .750" mounting x .461" height
VS5 PC Mount, U bracket, .750" mounting x .630" height

7. CONTACTS/TERMINALS

Contact	Material	Terminal Plating	Rating	Approvals
G	silver ⁶	gold over silver	6A 125VAC or 28VDC 3A 250VAC	
K	gold ⁷	tin ⁸	0.4VA max 20V max (AC/DC)	N/A
P	silver ⁶	gold over silver	6A 125VAC or 28VDC 3A 250VAC	
Q	silver ⁶	silver ⁶	6A 125VAC or 28VDC 3A 250VAC	
R	gold ⁷	gold ⁷	0.4VA max 20V max (AC/DC)	N/A

8. EPOXY SEAL

E Epoxy Seal **0** without Epoxy Seal

Notes:

- Hardware includes (2) 2MI-HDW2 nuts, (1) 2MI-HDW12 washer, and (1) 2MI-HDW17 locking ring
- Hardware includes (2) 2MI-HDW2 nuts, (1) 2MI-HDW11 washer, and (1) 2MI-HDW15 locking ring
- Tin option available with PC type terminations only.
- Available with circuit 1 only
- Black, white and red are standard. Other colors available, consult factory for details.
- Selection 5B is blank if actuator style is AP1 (no frame)
- Movable contact & terminal platings: silver over copper alloy
- Movable contact & terminal platings: gold over nickel over copper alloy
- Terminal platings: tin over nickel over copper alloy, available for PC mount terminations only

[Configure Complete Part Number >](#)

[Browse Standard Parts >](#)

3M-Series Accessories

To order a cap assembled on a switch, specify the switch number followed by the cap part number and the word "assembled". Ex: 3MN-SP-7-P2-B6-M6QE-C13ASSEMBLED. To order caps in bulk, specify the Series, followed by the cap. Ex: 3MN-C13

Optional Cap

Sample Part Number 3MN - C1 3

Selection 1 2 3

1. SERIES

3MN Fits 3MN, 3MS or 3MA

2. PUSHBUTTON CAP SIZE

C1 Round 8 mm diameter **C5**¹ Round 15 mm diameter
C2 Round 9.70 mm diameter **C6**² Brass Chrome Plated, 3.15 mm diameter
C3 Square 11.7 x 11.7 mm
C4 Round 5 mm diameter

3. CAP COLOR

1 White	5 Yellow
2 Black	6 Green
3 Red	7 Blue
4 Orange	

Notes:

- For 3MA with PL Bushing
- For 3MA with PD Bushing

Dimensional Specs

inches [millimeters]

Single Pole Maintained Circuit

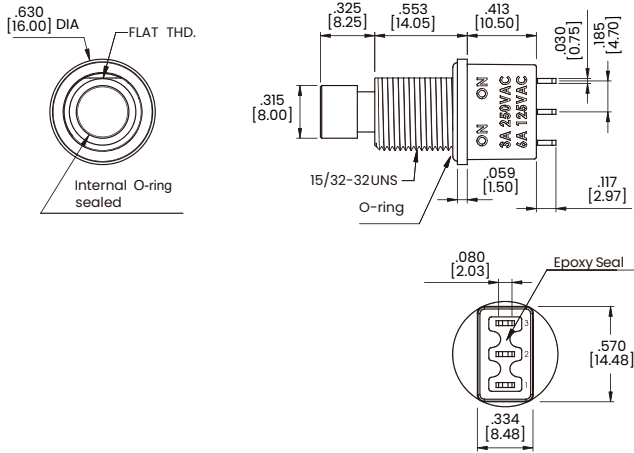

Single Pole Momentary Circuit

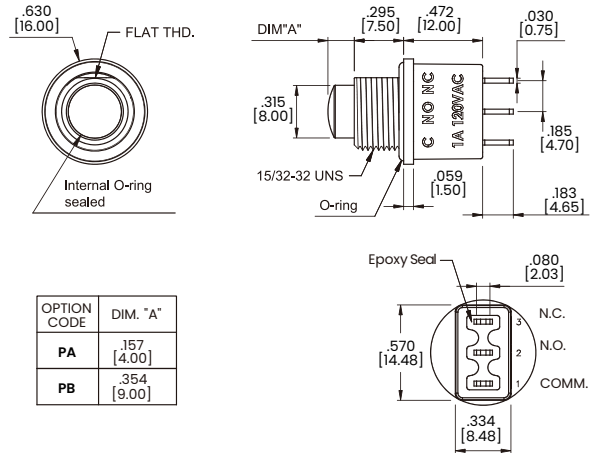

Double Pole Maintained Circuit

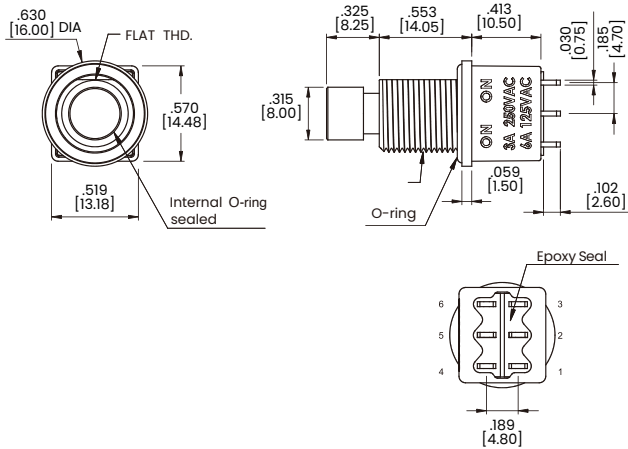

Double Pole Momentary Circuit

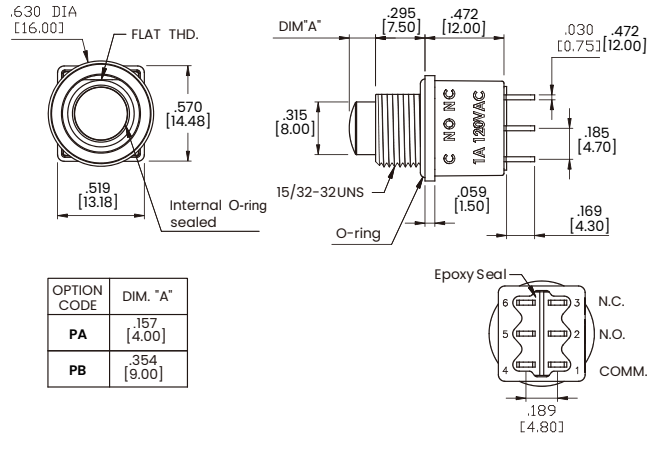

Panel Mounting

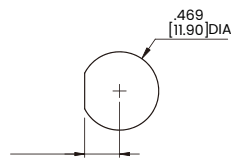

15/32-32 UNS FLAT-CUT
THREADED BUSHING

M1 Standard Solder Lug

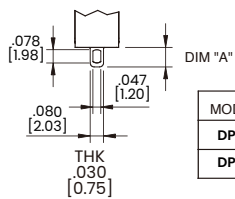

Termination Options

M2 PC Thru-Hole

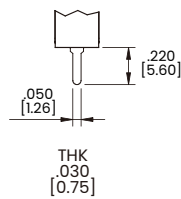

M5 Wire Wrap

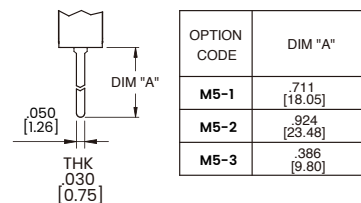

Dimensional Specs

inches [millimeters]

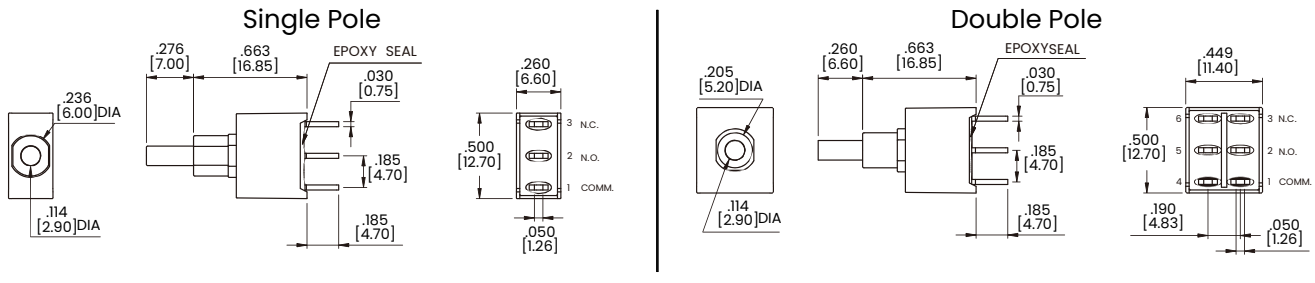

M6 Single Pole

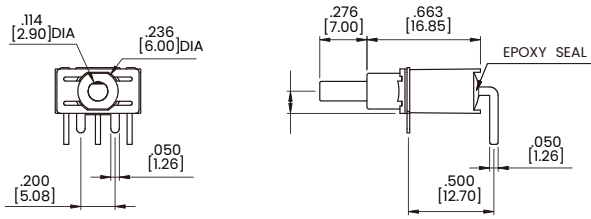

P.C.MOUNTING

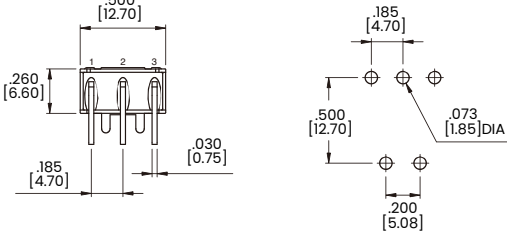

M6 Double Pole

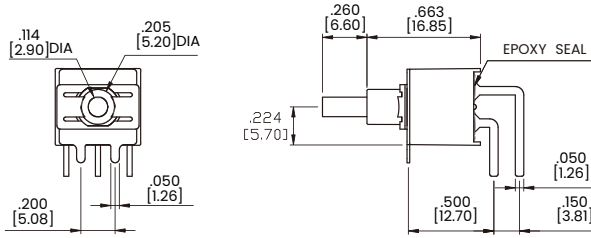

P.C.MOUNTING

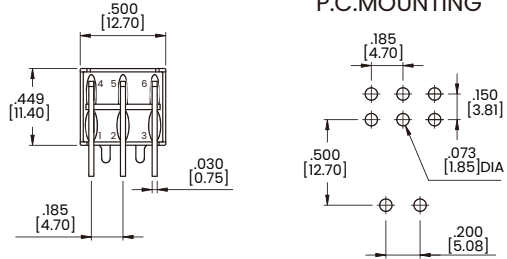

Plunger Options

For B1 Bushing

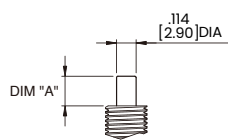

OPTION CODE	DIM. "A"
P1	.181 [4.60]
P2	.228 [5.80]
P3	.087 [2.20]

For B4 Bushing

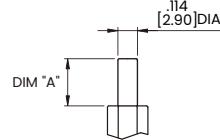

OPTION CODE	DIM. "A"
P1	.276 [7.00]
P2	.323 [8.20]
P3	.181 [4.60]

Bushing Options

B1

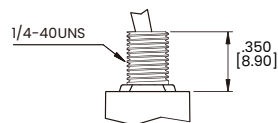

B4

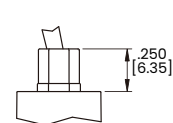

Dimensional Specs

inches [millimeters]

Termination Options

M1

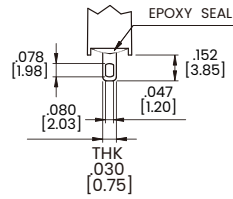

M2

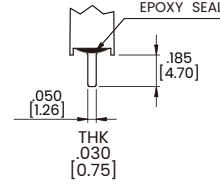

M7 Single Pole

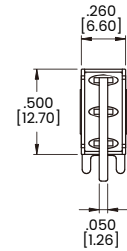
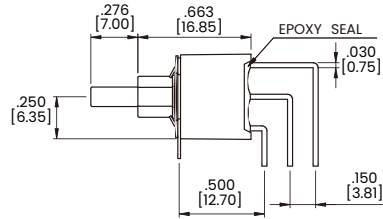
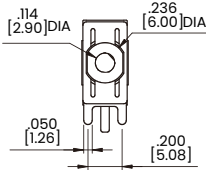

P.C.MOUNTING

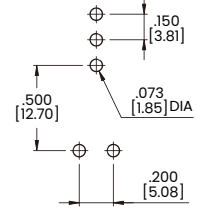

M7 Double Pole

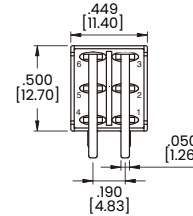
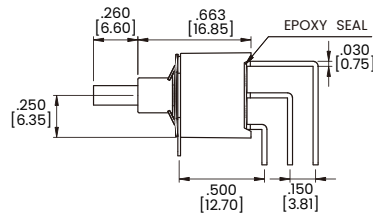
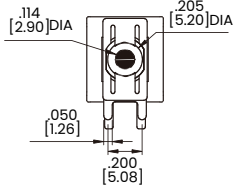

P.C.MOUNTING

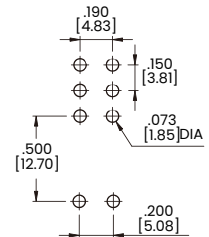

VS2-VS3 Single Pole

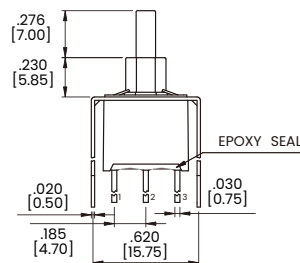
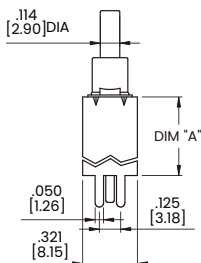

OPTION CODE	DIM.'A'
VS2	.461 [11.70]
VS3	.630 [16.00]

P.C.MOUNTING

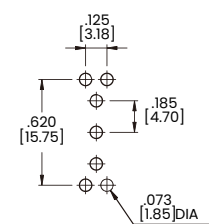

VS2-VS3 Double Pole

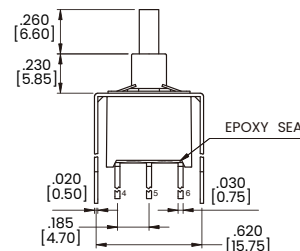
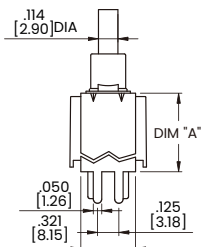

OPTION CODE	DIM.'A'
VS2	.461 [11.70]
VS3	.630 [16.00]

P.C.MOUNTING

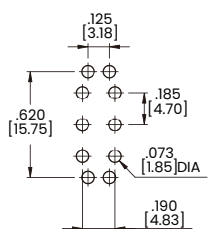

Dimensional Specs

inches [millimeters]

VS4-VS5 Single Pole

Termination Options

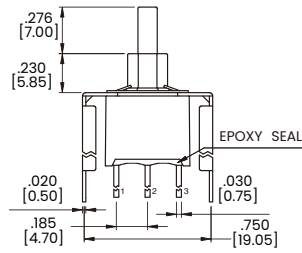
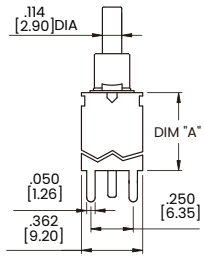

OPTION CODE	DIM.'A'
VS4	.461 [11.70]
VS5	.630 [16.00]

P.C.MOUNTING

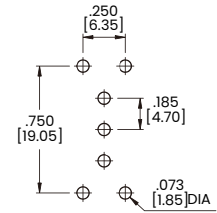

VS4-VS5 Double Pole

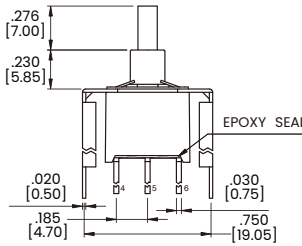
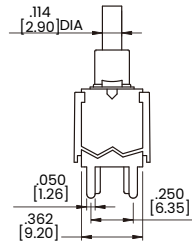

OPTION CODE	DIM.'A'
VS4	.461 [11.70]
VS5	.630 [16.00]

P.C.MOUNTING

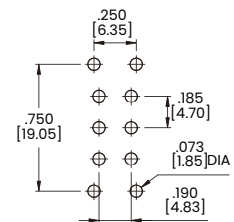

Snap-In Termination Options

M61

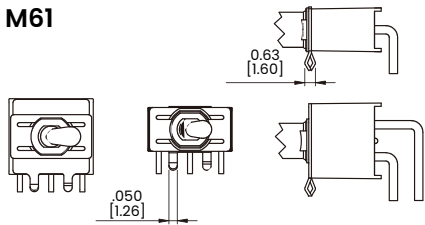

VS21, VS31

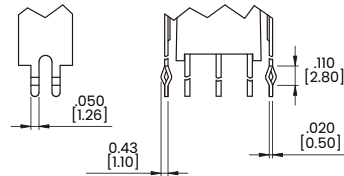

M71

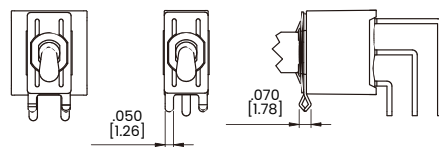

VS41, VS51

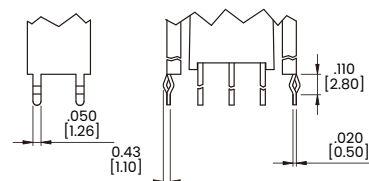

* PC Mounting for M61, M71, VS21, VS31, VS41, VS51 refer to M6, M7, VS2, VS3, VS4, VS5 respectively.

Dimensional Specs

inches [millimeters]

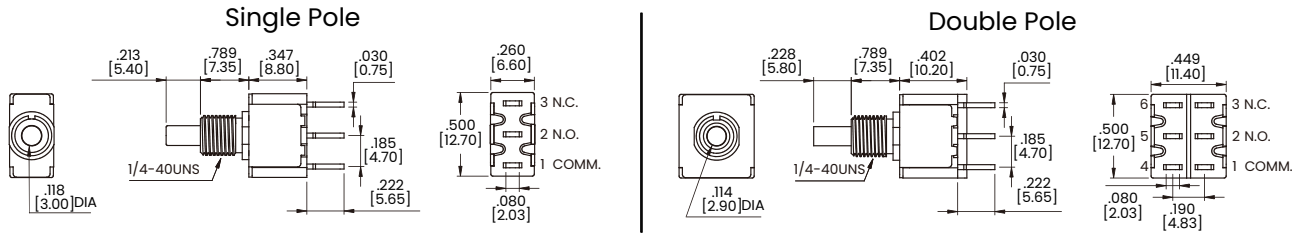

Plunger Options

For B1, B2, B3, B4 Bushing

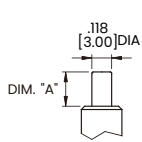

OPTION CODE	DIM. "A"
P0	.000 [0.00]
P1	.213 [5.40]
P2	.091 [2.30]

For B6 Bushing

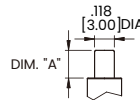

OPTION CODE	DIM. "A"
P1	.157 [4.00]
P2	.106 [2.70]

API

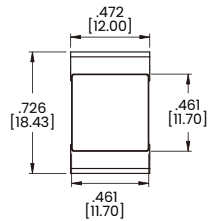

Actuator Options for Snap-In Front Mount

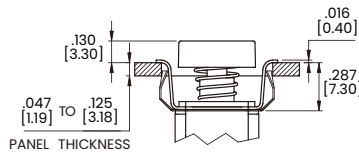

PANEL MOUNTING

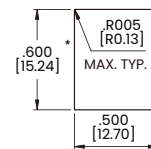

AP2 with Frame

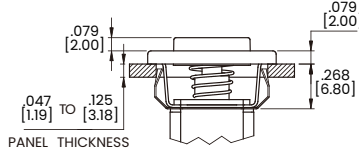
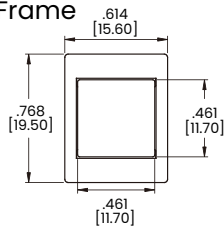

PANEL MOUNTING

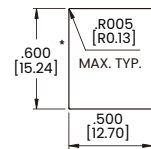

AP3 Flush CAP

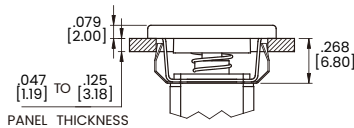
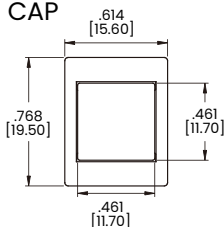

PANEL MOUNTING

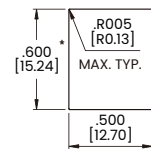

Bushing Options

B1 Threaded Standard
B2 Non-Threaded

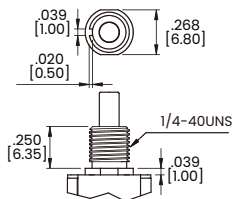

B3 Threaded Standard
B4 Non-Threaded

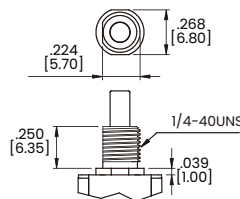

B6 Non-Threaded

(FOR TERMINATION OPTIONS VS6-VS9 ONLY)

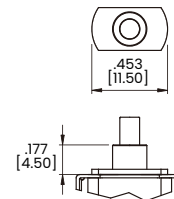

Dimensional Specs

inches [millimeters]

Termination Options

M1 Standard Solder Lug

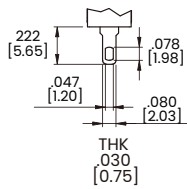

M2 PC Thru-Hole

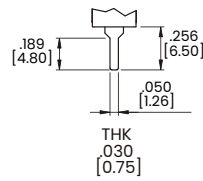

M5 Wire Wrap

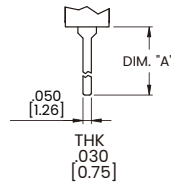

OPTION CODE	DIM. "A"
M5-1	.750 [19.05]
M5-2	.964 [24.48]
M5-3	.425 [10.80]

M6 Single Pole

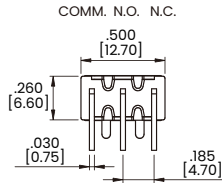
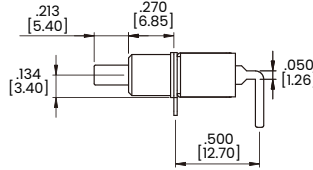
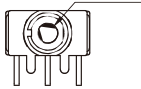

P.C.MOUNTING

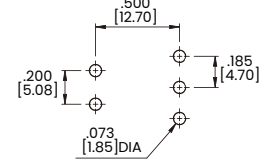

M6 Double Pole

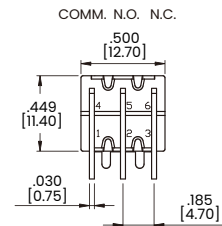
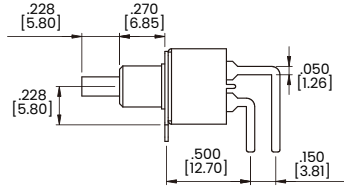
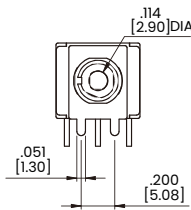

P.C.MOUNTING

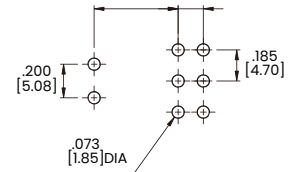

M7 Single Pole

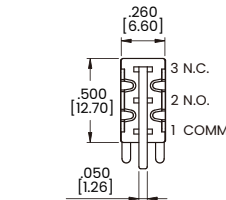
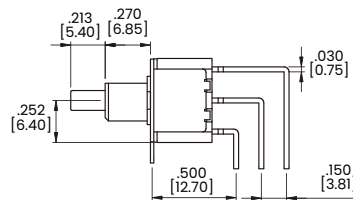
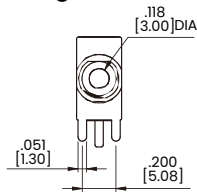

P.C.MOUNTING

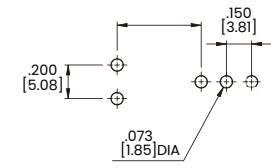

M7 Double Pole

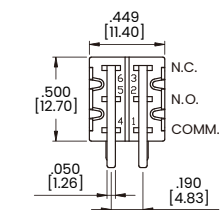
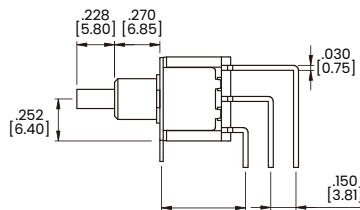
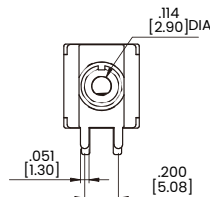

P.C.MOUNTING

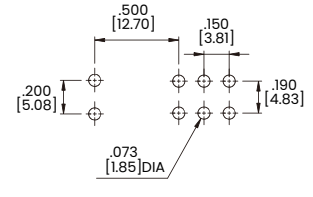

VS2-VS3 Single Pole

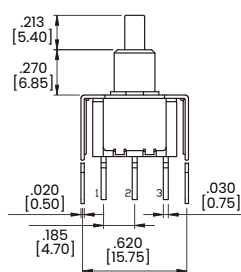
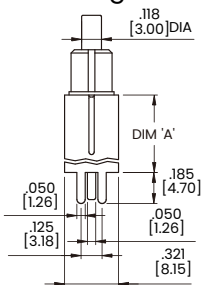

OPTION CODE	DIM.'A'
VS2	.461 [11.70]
VS3	.630 [16.00]

P.C.MOUNTING

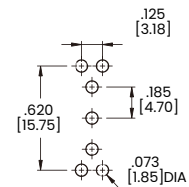

Dimensional Specs

inches [millimeters]

Termination Options

VS2-VS3 Double Pole

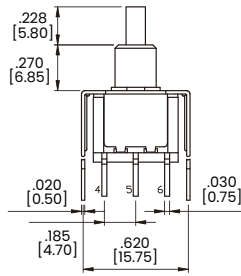
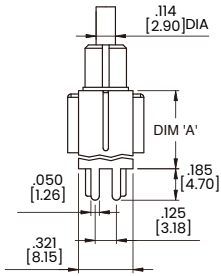

OPTION CODE	DIM. 'A'
VS2	.461 [11.70]
VS3	.630 [16.00]

P.C.MOUNTING

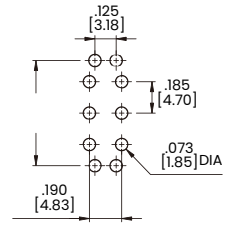

VS4-VS5 Single Pole

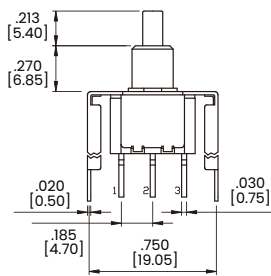
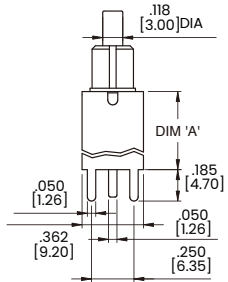

OPTION CODE	DIM. 'A'
VS4	.461 [11.70]
VS5	.630 [16.00]

P.C.MOUNTING

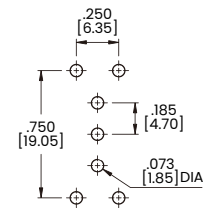

VS4-VS5 Double Pole

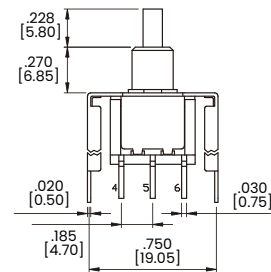
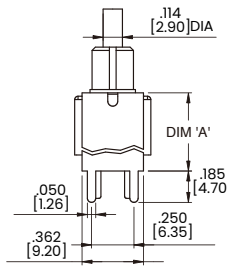

OPTION CODE	DIM. 'A'
VS4	.461 [11.70]
VS5	.630 [16.00]

P.C.MOUNTING

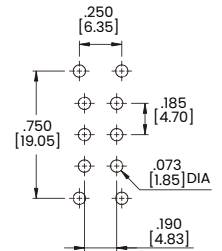

VS6-VS7 Single Pole (FOR B6 BUSHING ONLY)

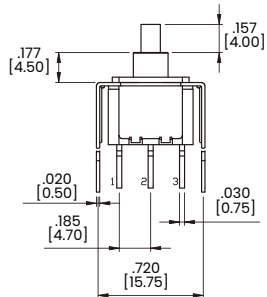
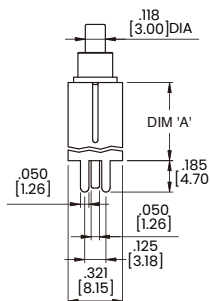

OPTION CODE	DIM. 'A'
VS6	.461 [11.70]
VS7	.630 [16.00]

P.C.MOUNTING

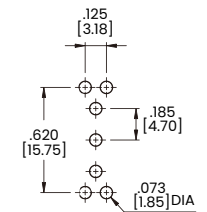

Dimensional Specs

inches [millimeters]

Termination Options

VS6-VS7 Double Pole (FOR B6 BUSHING ONLY)

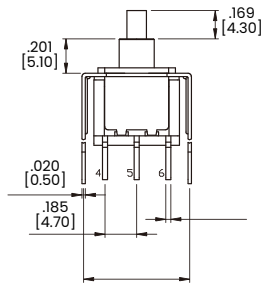
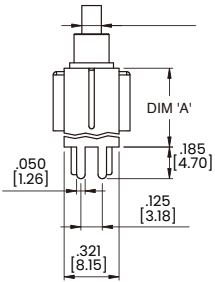

OPTION CODE	DIM.'A'
VS6	.461 [11.70]
VS7	.630 [16.00]

P.C.MOUNTING

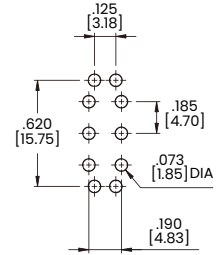

VS8-VS9 Single Pole (FOR B6 BUSHING ONLY)

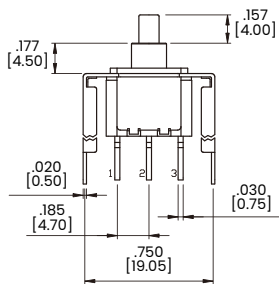
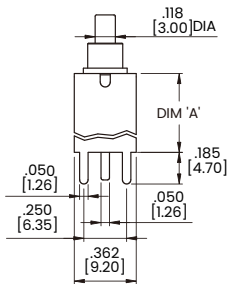

OPTION CODE	DIM.'A'
VS8	.461 [11.70]
VS9	.630 [16.00]

P.C.MOUNTING

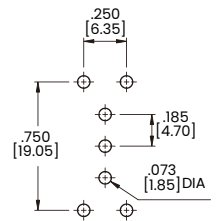

VS8-VS9 Double Pole (FOR B6 BUSHING ONLY)

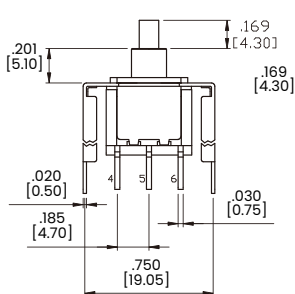
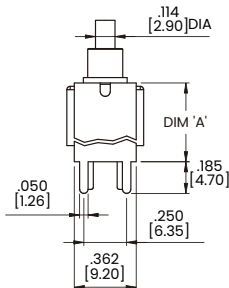

OPTION CODE	DIM.'A'
VS8	.461 [11.70]
VS9	.630 [16.00]

P.C.MOUNTING

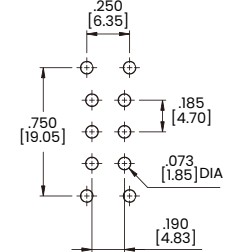

Snap-In Termination Options

VS21, VS31

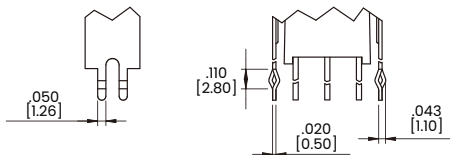

VS41, VS51

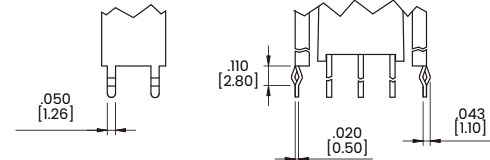

* PC Mounting for VS21, VS31, VS41, VS51 refer to VS2, VS3, VS4, VS5 respectively.

Dimensional Specs

inches [millimeters]

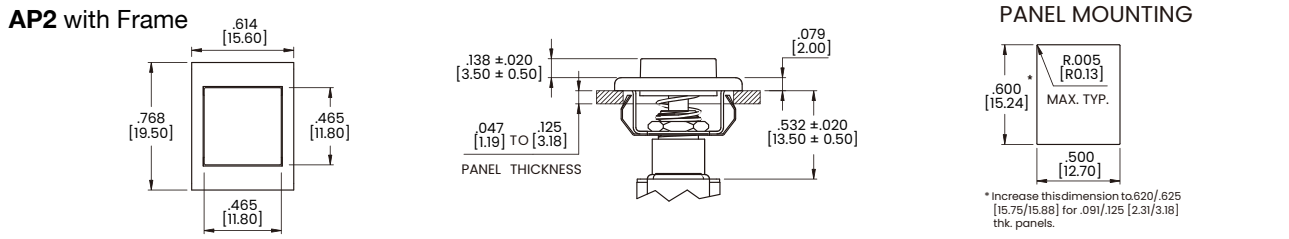
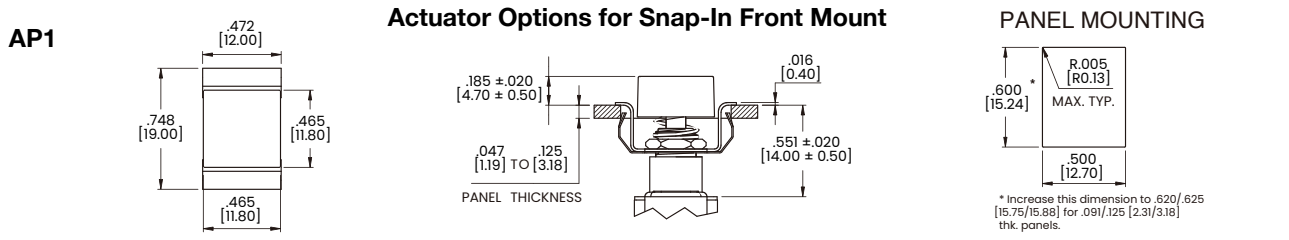
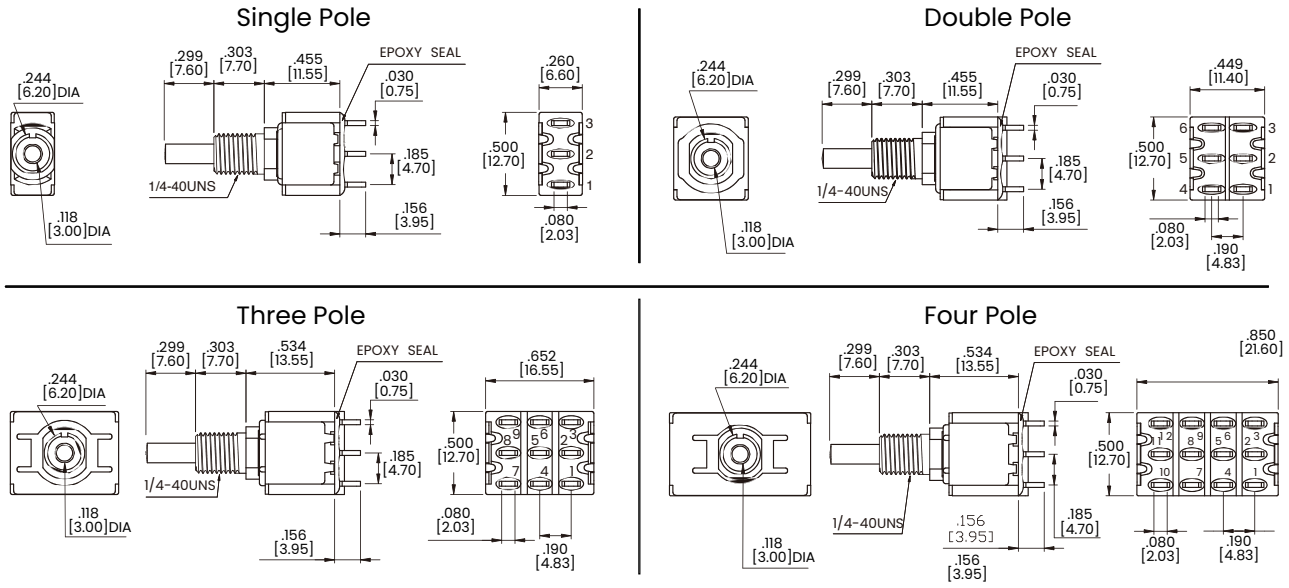

Plunger Options

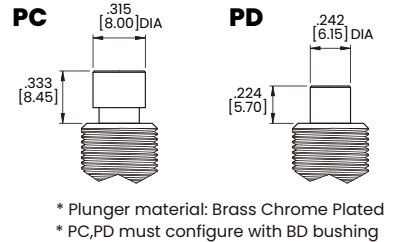
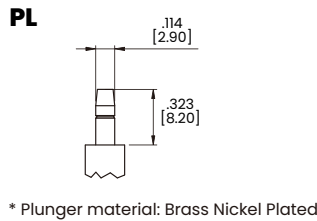
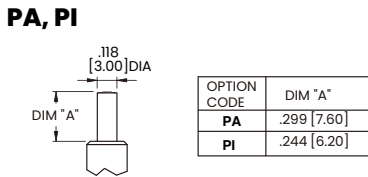

Dimensional Specs

inches [millimeters]

Bushing Options

B10 Threaded Standard
B20 Non-Threaded

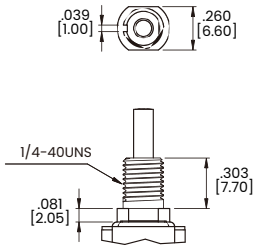

B21 Non-Threaded

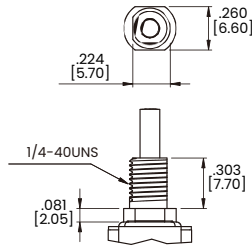

BD Threaded Standard

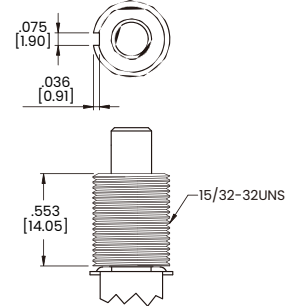

Termination Options

M1 Standard Solder Lug

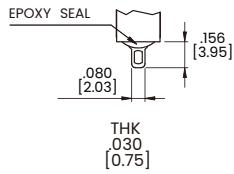

M2 PC Thru-Hole

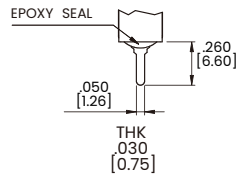

M5 Wire Wrape

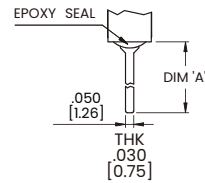

OPTION CODE	DIM.'A'
M5-1	.750 [19.05]
M5-2	.964 [24.48]
M5-3	.425 [10.80]
M5-4	1.062 [26.97]

M6 Single Pole

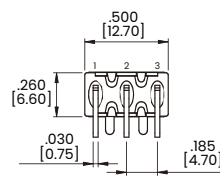
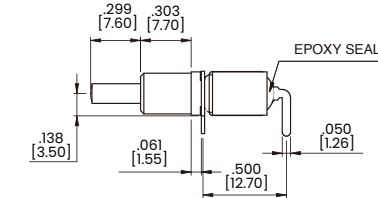
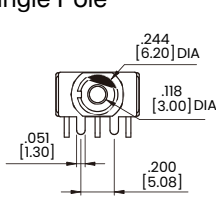

P.C.MOUNTING

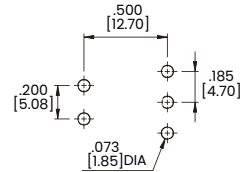

M6 Double Pole

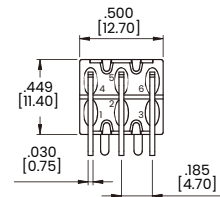
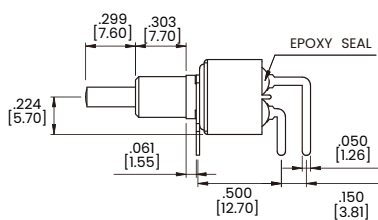
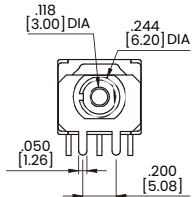

P.C.MOUNTING

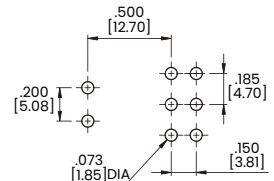

M7 Single Pole

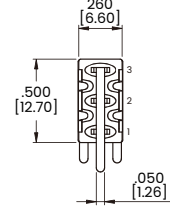
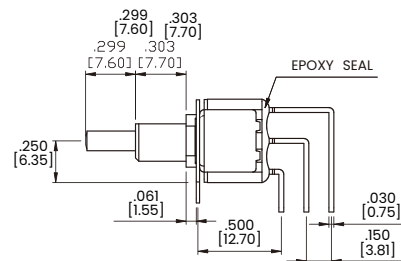
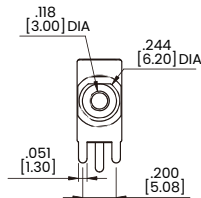

P.C.MOUNTING

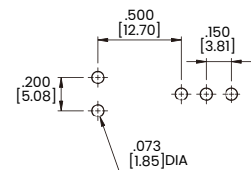

Dimensional Specs

inches [millimeters]

Termination Options

M7 Double Pole

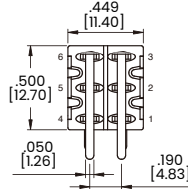
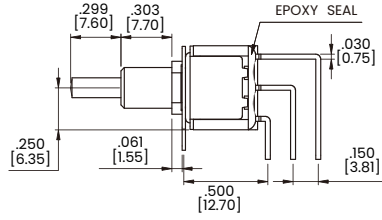
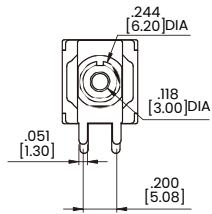

P.C.MOUNTING

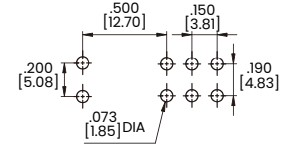

M7 Three Pole

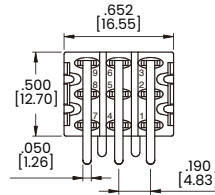
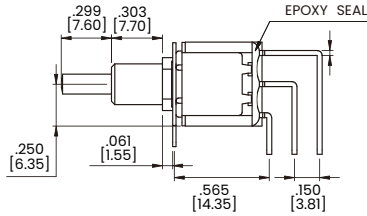
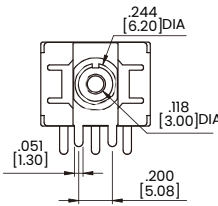

P.C.MOUNTING

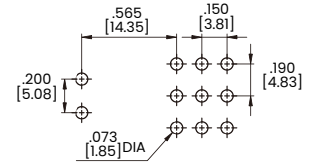

M7 Four Pole

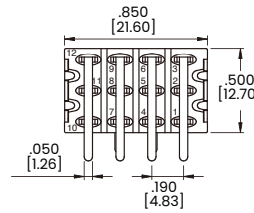
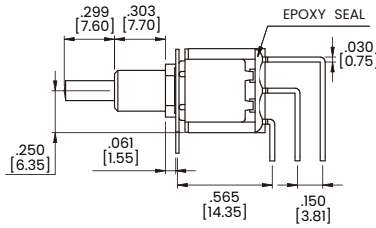
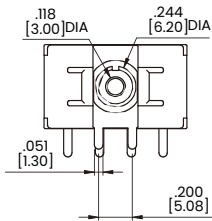

P.C.MOUNTING

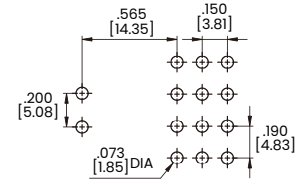

VS2-VS3 Single Pole

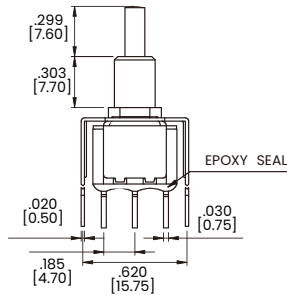
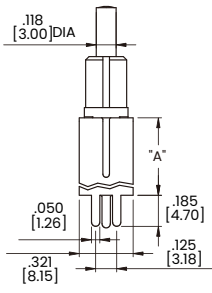

OPTION CODE	DIM.'A'
VS2	.461 [11.70]
VS3	.630 [16.00]

P.C.MOUNTING

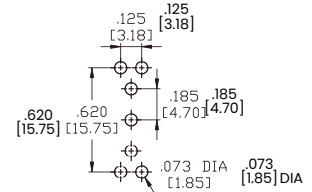

VS2-VS3 Double Pole

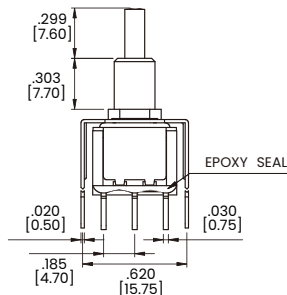
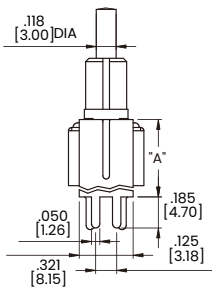

OPTION CODE	DIM.'A'
VS2	.461 [11.70]
VS3	.630 [16.00]

P.C.MOUNTING

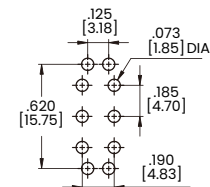

Dimensional Specs

inches [millimeters]

Termination Options

VS4-VS5 Single Pole

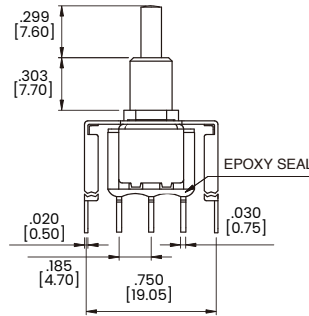
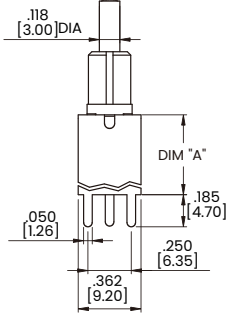

OPTION CODE	DIM.'A'
VS4	.461 [11.70]
VS5	.630 [16.00]

P.C.MOUNTING

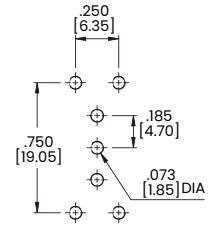

VS4-VS5 Double Pole

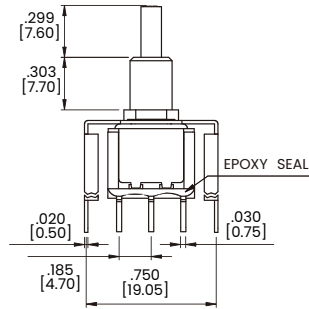
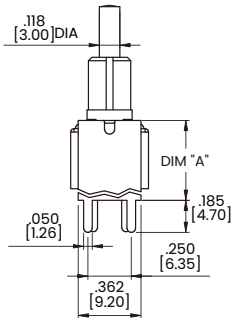

OPTION CODE	DIM.'A'
VS4	.461 [11.70]
VS5	.630 [16.00]

P.C.MOUNTING

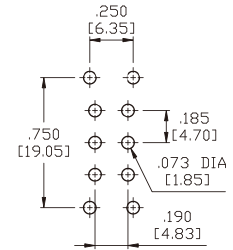

Panel Mounting

1/4 INCH BUSHING

B10

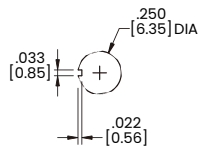

B20

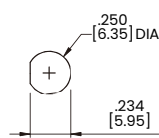

B21

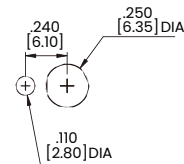

15/32 INCH BUSHING

BD

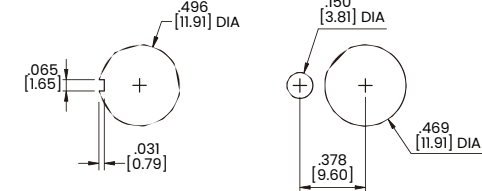

Plunger Caps

C1

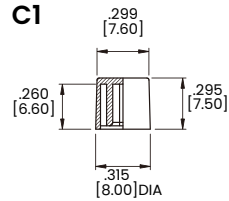

C2

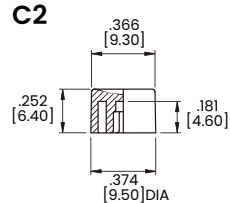

C3

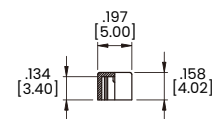
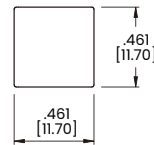

C5

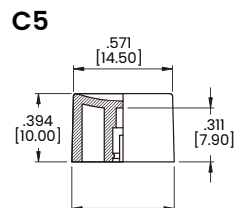

For PL plunger only

C6

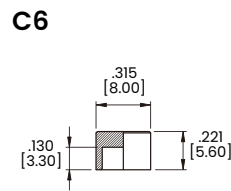

For PD plunger only

C7

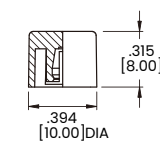

For PL plunger only

CAP AND FRAME COLORS			
1	White	6	Green
2	Black	7	Blue
3	Red	8	Brown
4	Orange	9	Gray
5	Yellow		

MATERIAL: ABS for C1-C5, C7
MATERIAL: Chrome plated brass for C6

Authorized Sales Representatives and Distributors

Click on a region of the map below to find your local representatives and distributors or visit www.carlingtech.com/findarep.



About Carling

Founded in 1920, Carling Technologies is a leading manufacturer of electrical and electronic switches and assemblies, circuit breakers, electronic controls, power distribution units, and multiplexed power distribution systems. With six ISO9001 and IATF16949 registered manufacturing facilities and technical sales offices worldwide, Carling Technologies Sales, Service and Engineering teams do much more than manufacture electrical components, they engineer powerful solutions! To learn more about Carling please visit www.carlingtech.com/company-profile.

To view all of Carling's environmental, quality, health & safety certifications please visit www.carlingtech.com/environmental-certifications.

© Carling Technologies, Inc.

Carling is a registered trademark of Carling Technologies, Inc. in the U.S. and other countries.