

Circuit Breaker for Equipment thermal-magnetic, 3 poles



See below:

[Approvals and Compliances](#)

### Description

- Thermal-magnetic circuit breaker
- High short circuit performance
- Availability of AC and DC in the same frame size
- DIN-Rail Mounting

### Applications

- Industrial appliances

### References

Last order possibility: 31.08.2018  
 Last delivery date: 30.09.2018

### Weblinks

[pdf datasheet](#), [html-datasheet](#), [General Product Information](#), [Distributor-Stock-Check](#), [Detailed request for product](#), [Product News](#)

### Technical Data

#### General data

Rated Voltage DC	IEC 360 V UL/CSA 360 V
Rated current	0.5 - 50 A , see approbations
Conditional short circuit capacity IEC 60934	Icn: DC 360 V: 4.5 kA (no fuse)
Conditional short circuit capacity UL 1077	Icn: DC 360 V: 10 kA (no fuse)
Degree of Protection	from front side IP 40 acc. to IEC 60529
Dielectric Strength	50Hz: > 2kV Impulse 1.2/50 µs
Vibration Resistance	± 0.75 mm @ 5 - 60 Hz acc. to IEC 60068-2-6, test Fc 10 G @ 60 - 500 Hz acc. to IEC 60068-2-6, test Fc
Insulation Resistance	250/440VAC > 5 MΩ
Shock Resistance	30 G / 18ms acc. to IEC 60068-2-27, test Ea
Ambient temperature	-10°C to 55°C
Weight	100 - 130g

Tripping Type	Positively trip free
Actuation Type	Manual ON/OFF
Permissible wire cross section	1.5 - 25 mm <sup>2</sup> / 16 - 4 AWG

#### Switched neutral

Rated Voltage	AC 277 V
Rated current	AC/DC 65 A
Function	The switched neutral closes with manual closure of the poles and opens automatically with thermal magnetic tripping of the poles.

#### Add-on modules

Add-on modules	Technical data for the additional module see separate data sheet
----------------	--

### Approvals and Compliances

Detailed information on product approvals, code requirements, usage instructions and detailed test conditions can be looked up in [Details about Approvals](#)

### Approvals



The approval mark is used by the testing authorities to certify compliance with the safety requirements placed on electronic products.

Approval Reference Type: AS168X

Approval Logo	Certificates	Certification Body	Description
	<a href="#">VDE Approvals</a>	VDE	VDE Certificate Number: 40005743
	<a href="#">UL Approvals</a>	UL	UL File Number: E216629 / E71572
	<a href="#">UL Approvals</a>	UL	UL File Number: E216629 / E71572

## Product standards

Product standards that are referenced

Organization	Design	Standard	Description
	Designed according to	IEC 60934	Circuit-breakers for equipment (CBE)
	Designed according to	UL 1077	Standard for Supplementary Protectors for Use in Electrical Equipment
	Designed according to	CSA C22.2	Supplementary Protectors





## Application standards

Application standards where the product can be used

Organization	Design	Standard	Description
	Designed for applications acc.	IEC/UL 60950	IEC 60950-1 includes the basic requirements for the safety of information technology equipment.

## Compliances

The product complies with following Guide Lines

Identification	Details	Initiator	Description
	<a href="#">CE declaration of conformity</a>	SCHURTER AG	The CE marking declares that the product complies with the applicable requirements laid down in the harmonisation of Community legislation on its affixing in accordance with EU Regulation 765/2008.
	<a href="#">RoHS</a>	SCHURTER AG	EU Directive RoHS 2011/65/EU
	<a href="#">China RoHS</a>	SCHURTER AG	The law SJ / T 11363-2006 (China RoHS) has been in force since 1 March 2007. It is similar to the EU directive RoHS.
	<a href="#">REACH</a>	SCHURTER AG	On 1 June 2007, Regulation (EC) No 1907/2006 on the Registration, Evaluation, Authorization and Restriction of Chemicals 1 (abbreviated as "REACH") entered into force.

## Dimension [mm]

AS168X 3 pole

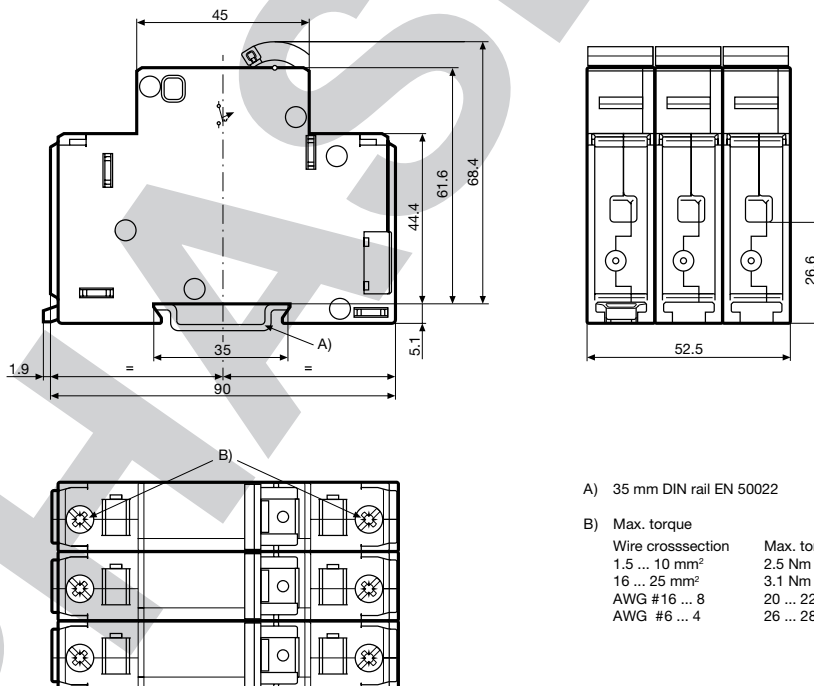

A) 35 mm DIN rail EN 50022

B) Max. torque	
Wire crosssection	Max. torque
1.5 ... 10 mm <sup>2</sup>	2.5 Nm
16 ... 25 mm <sup>2</sup>	3.1 Nm
AWG #16 ... 8	20 ... 22 lb-in
AWG #6 ... 4	26 ... 28 lb-in

AS168X 3 pole and switched neutral pole

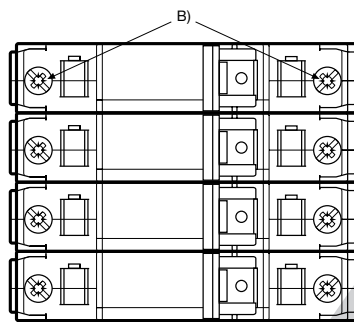
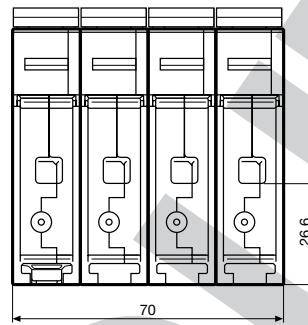
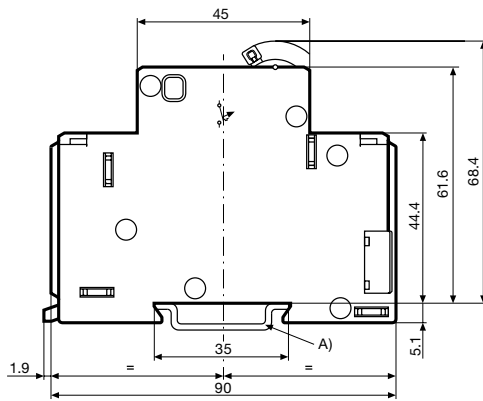

A) 35 mm DIN rail EN 50022

B) Max. torque

Wire crossection	Max. torque
1.5 ... 10 mm <sup>2</sup>	2.5 Nm
16 ... 25 mm <sup>2</sup>	3.1 Nm
AWG #16 ... 8	20 ... 22 lb-in
AWG #6 ... 4	26 ... 28 lb-in

Diagrams

AS168X-CB1...

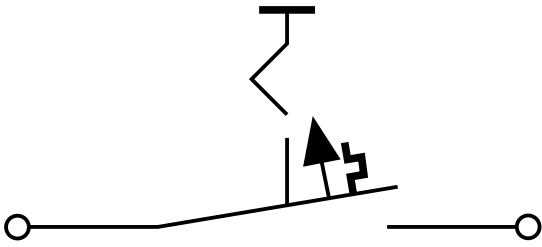

AS168X-CB1...N

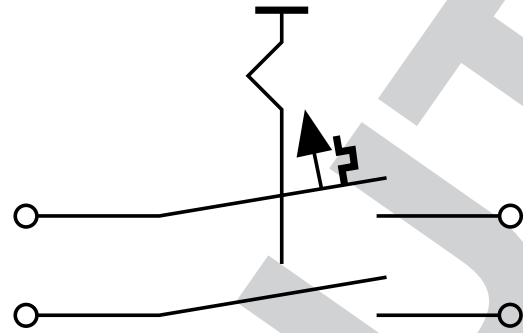

AS168X-CB1... / AS168X-ACBH1

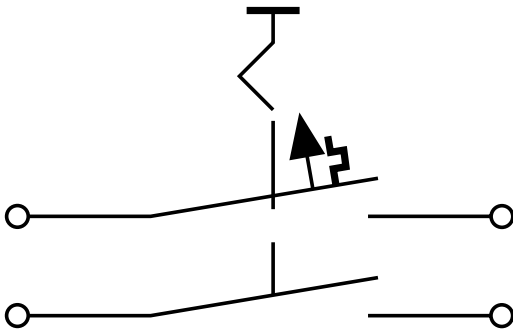

AS168X-CB1... / AS168X-ACBH2

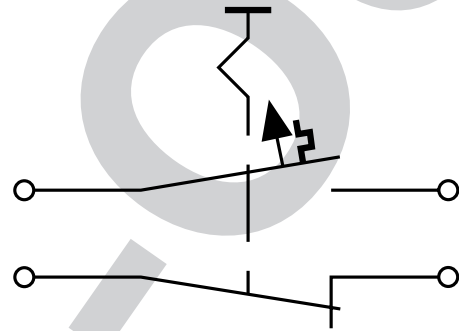

AS168X-CB1... / AS168X-ACBS1

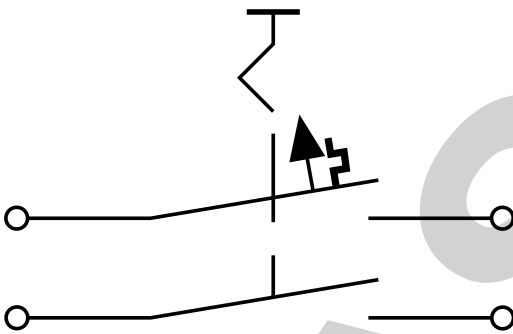



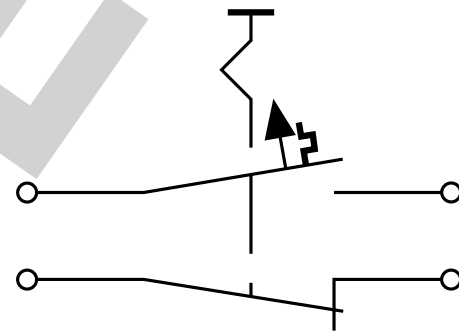

AS168X-CB1... / AS168X-ACBS2

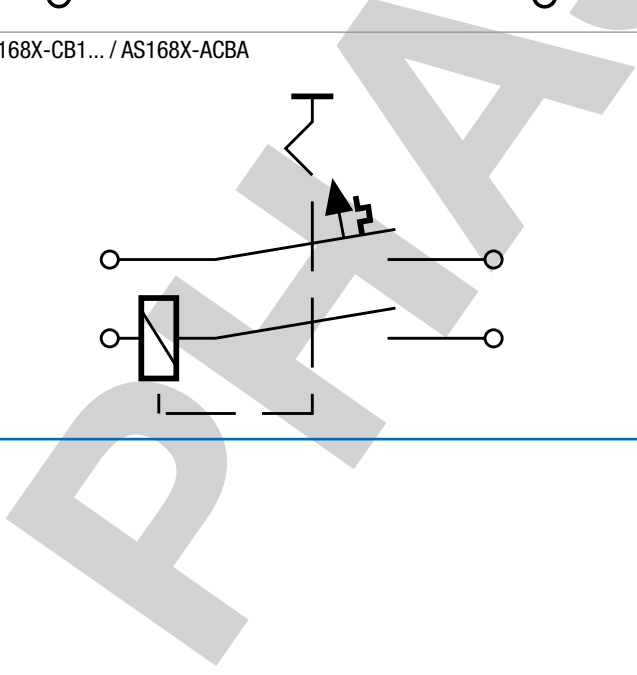
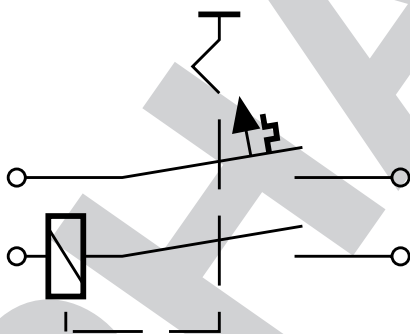

AS168X-CB1... / AS168X-ACBA



Symbol	Standard	Rated current	Rated voltage DC	Conditional short circuit capacity Icn
	UL 508 CSA C22.2 no. 14	-	-	-
	UL 1077	0.5 - 40 A	360 V	10 kA
	CSA C22.2 no. 235	-	-	-
	EN 60934	0.5 - 50 A	360 V	4.5 kA
	GB 17701	-	-	-

### Effect of ambient temperature

AC-breaker are calibrated for an ambient temperature of +40°C, DC-breakers for +23°C. To determine the rated current for a lower or higher ambient temperature, use a correction factor from the table below:

Ambient temperature [°C]	Correction factor AC version	Correction factor DC version
-20	0.78	0.80
-5	0.82	0.87
0	0.83	0.90
+10	0.87	0.95
+23	0.91	1.00
+30	0.95	1.05
+40	1.00	1.10
+50	1.05	1.20
+60	1.11	1.30

Example DC version: Rated current = 10 A; Environmental temperature = 50 °C; --> Correction factor = 1.2; Resulting current = 12 A

### Time-Current-Curves

Version DF / Magnetic 4.5-8 xI<sub>n</sub>

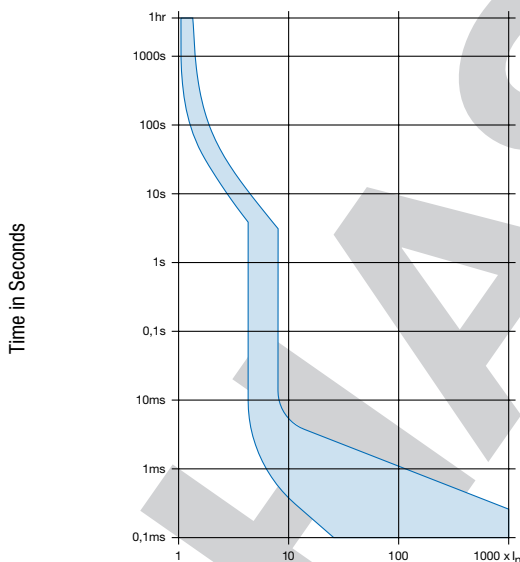

Multiple of Rated Current In

Reference Temperature +23°

Version DG / Magnetic 9-16 xI<sub>n</sub>

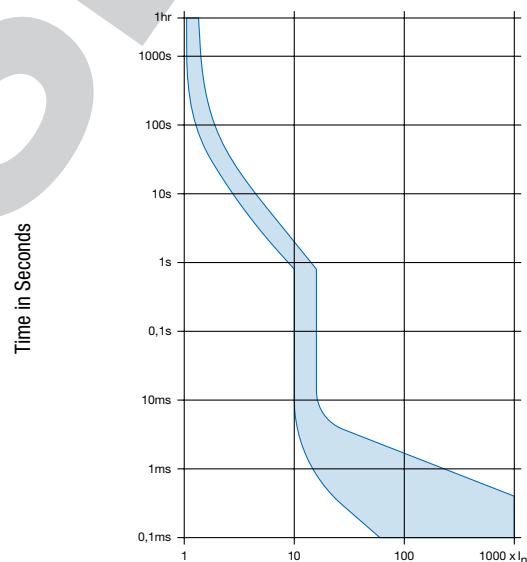

Multiple of Rated Current In

Reference Temperature +23°

Version DH / Magnetic 18-32 x I<sub>n</sub>

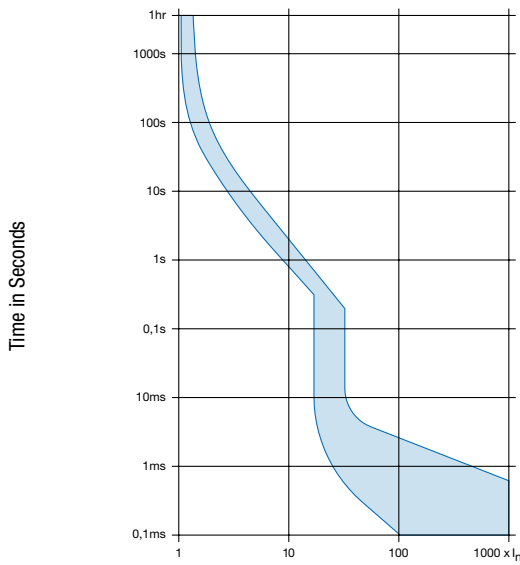

Multiple of Rated Current I<sub>n</sub>

Reference Temperature +23°

### Config. Code

AS168X-CB 1 DG 200 N

The characters are placeholders for the correspondingly keys of selections from the key tables.

AS168X-CB **1** DG 200 N = Number of Poles

Number of Poles

3-pole

Configuration key

3

AS168X-CB 1 **DG** 200 N = Tripping characteristics

Tripping characteristics

1.05-1.35xI<sub>n</sub> / 4.5-8xI<sub>n</sub> / 0.5-50 A

1.05-1.35xI<sub>n</sub> / 9-16xI<sub>n</sub> / 0.5-50 A

1.05-1.35xI<sub>n</sub> / 18-32xI<sub>n</sub> / 6.0-50 A

Configuration key

DF

DG

DH

AS168X-CB 1 DG **200** N = Rated current

Rated current

0.05 A

1.0 A

1.5 A

2.0 A

3.0 A

4.0 A

5.0 A

6.0 A

7.0 A

Configuration key

005

010

015

020

030

040

050

060

070

Other rated currents on request

Rated current

8.0 A

9.0 A

10.0 A

12.0 A

15.0 A

16.0 A

18.0 A

20.0 A

23.0 A

25.0 A

27.0 A

30.0 A

32.0 A

35.0 A

40.0 A

45.0 A

50.0 A

Other rated currents on request

Configuration key

080

090

100

120

150

160

180

200

230

250

270

300

320

350

400

450

500

AS168X-CB 1 DG 200 **N** = Switched neutral

Switched neutral

Switched neutral pole

Configuration key

N

**Variants**

Tripping characteristics	Rated current	Switched neutral	Config. Code	Order Number
1.05-1.35xIn / 9-16xIn / 0.5-50 A	2.0 A		AS168X-CB3DG020	4420.0607
1.05-1.35xIn / 9-16xIn / 0.5-50 A	20.0 A		AS168X-CB3DG200	4420.0940

Availability for all products can be searched real-time:<https://www.schurter.com/en/Stock-Check/Stock-Check-SCHURTER>

**Packaging Unit** 1 Pcs

PHASE-OUT