

LE CG P2AQ

OSRAM OSTAR® Projection Power

OSRAM OSTAR Projection Power is a high luminance LED for projection applications.

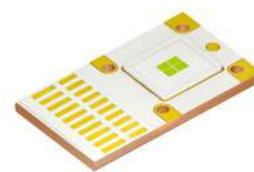

Applications

- Projection Home LED & Laser
- Projection Professional LED & Laser

Features:

- Package: OSTAR High Power Projection
- Chip technology: UX:3
- Typ. Radiation: 120° (Lambertian emitter)
- Color: Cx = 0.32, Cy = 0.64 acc. to CIE 1931 (● converted green)
- ESD: 2 kV acc. to ANSI/ESDA/JEDEC JS-001 (HBM, Class 2)

Ordering Information

Type	Luminous Flux ¹⁾ I _F = 6000 mA Φ _v	Ordering Code
LE CG P2AQ-VRWP-A	8200 ... 12100 lm	Q65112A7818

Maximum Ratings

Parameter	Symbol		Values
Storage Temperature	T_{stg}	min. max.	-40 °C 85 °C
Junction Temperature	T_j	max.	150 °C
Forward Current $T_j = T_{j,max}$	I_F	min. max.	200 mA 10000 mA
Forward Current pulsed $D = 0.7; f = 240 \text{ Hz}; T_j = T_{j,max}$	$I_{F \text{ pulse}}$		12000 mA
Surge Current $t_p \leq 50 \mu\text{s}; D = 0.1; T_j = T_{j,max}$	I_{FS}	max.	14000 mA
ESD withstand voltage acc. to ANSI/ESDA/JEDEC JS-001 (HBM, Class 2)	V_{ESD}		2 kV
Reverse current ²⁾	I_R	max.	200 mA
Max. voltage difference anode-board, cathode-board	$ \Delta V_{a-b} , \Delta V_{c-b} $	max.	40 V

Characteristics

$T_{\text{Board}} = 25 \text{ °C}$; $I_{\text{F}} = 6000 \text{ mA}$; $f = 1000 \text{ Hz}$; $D = 0.5$

Parameter	Symbol		Values
Chromaticity Coordinate ³⁾ within $\lambda = 500 \dots 600 \text{ nm}$	C_x	typ.	0.32
	C_y	typ.	0.64
Peak Wavelength	λ_{peak}	typ.	520 nm
Spectral bandwidth at 50% $I_{\text{rel,max}}$	$\Delta\lambda$	typ.	96 nm
Viewing angle at 50% I_{v}	2φ	typ.	120 °
Radiating surface	A_{color}	typ.	3.2 x 2.6 mm ²
Partial Flux acc. CIE 127:2007 ⁴⁾ $I_{\text{F}} = 6000 \text{ mA}$	$\Phi_{\text{E/V, } 120^\circ}$	typ.	0.77
Forward Voltage ⁵⁾ $I_{\text{F}} = 6000 \text{ mA}$	V_{F}	min.	12.8 V
		typ.	14.0 V
		max.	15.2 V
Reverse voltage (ESD device)	$V_{\text{R ESD}}$	min.	45 V
Reverse voltage ²⁾ $I_{\text{R}} = 20 \text{ mA}$	V_{R}	max.	1.2 V
Real thermal resistance junction/board	$R_{\text{thJB real}}$	typ.	0.7 K / W
Electrical thermal resistance junction/board with efficiency $\eta_{\text{e}} = 26 \text{ %}$	$R_{\text{thJB elec.}}$	typ.	0.52 K / W

Brightness Groups

Group	Luminous Flux ¹⁾ $I_F = 6000 \text{ mA}$ min. Φ_V	Luminous Flux ¹⁾ $I_F = 6000 \text{ mA}$ max. Φ_V
VR	8200 lm	8920 lm
VS	8920 lm	9700 lm
VT	9700 lm	10420 lm
VU	10420 lm	11200 lm
WP	11200 lm	12100 lm

Chromaticity Coordinate Groups

within $\lambda = 500 \dots 600 \text{ nm}$

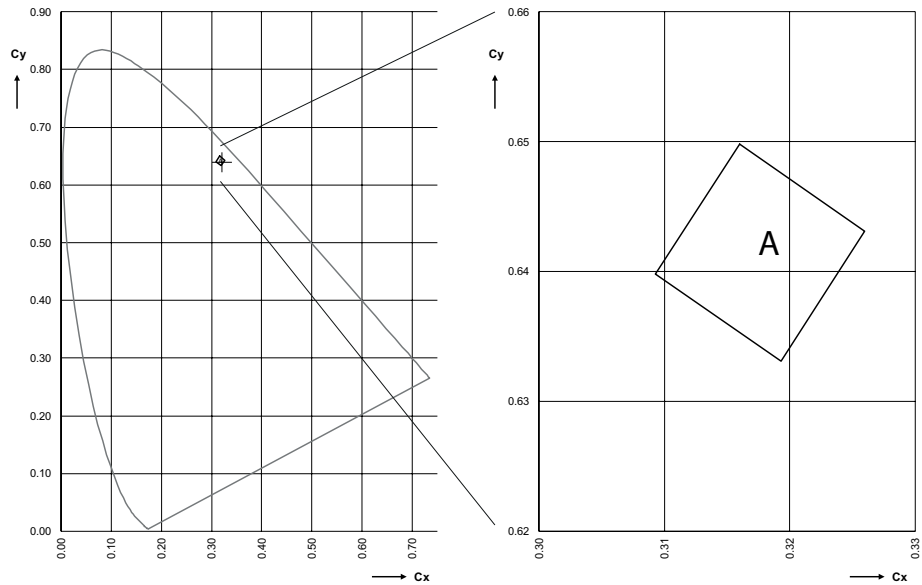

Chromaticity Coordinate Groups ³⁾

Group	Cx	Cy
A	0.3093	0.6398
	0.3160	0.6498
	0.3260	0.6431
	0.3193	0.6331

Group Name on Label

Example: VR-A

Brightness

Color Chromaticity

VR

A

Relative Spectral Emission ⁴⁾

$\Phi_{rel} = f(\lambda); I_F = 6000 \text{ mA}; T_J = 25 \text{ }^\circ\text{C}$

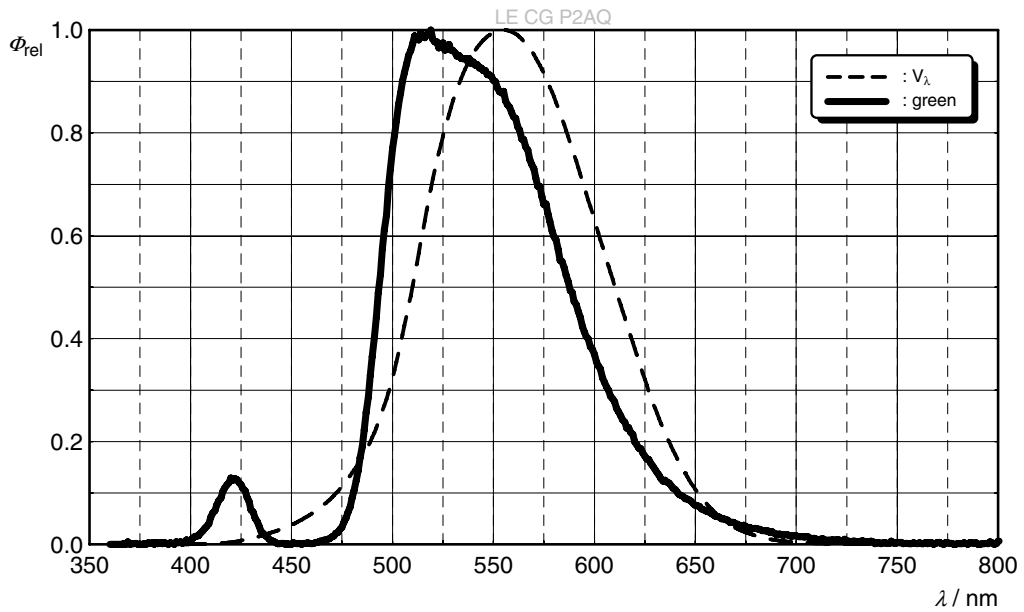

Radiation Characteristics ⁴⁾

$I_{rel} = f(\phi); T_J = 25 \text{ }^\circ\text{C}$

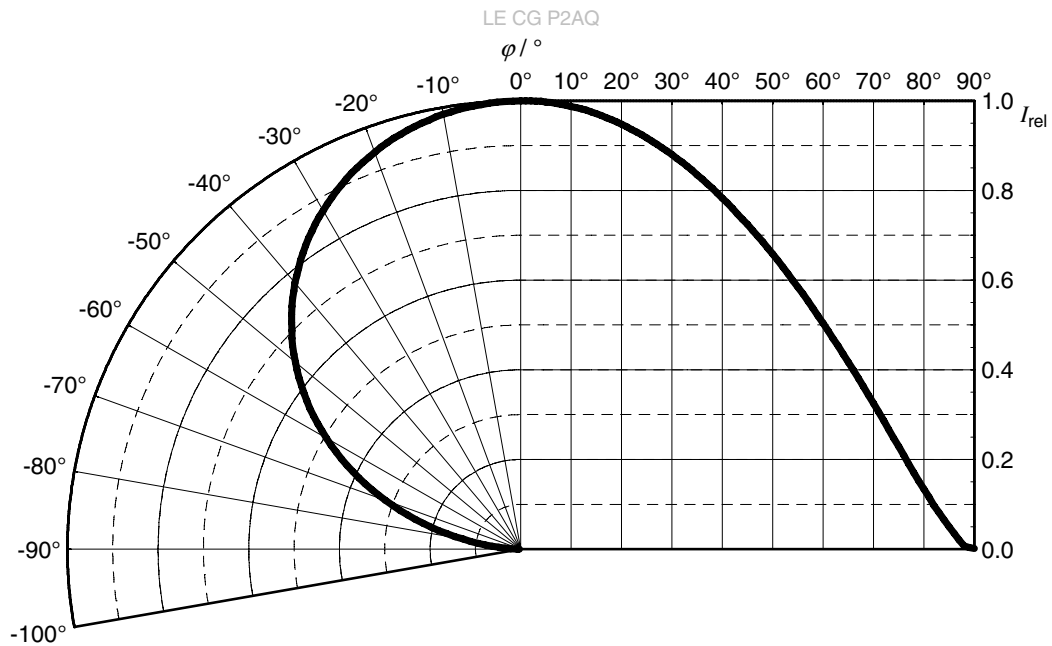

Relative Partial Flux ⁴⁾

$\Phi_V(2\varphi)/\Phi_V(180^\circ) = f(\varphi); T_J = 25^\circ\text{C}$

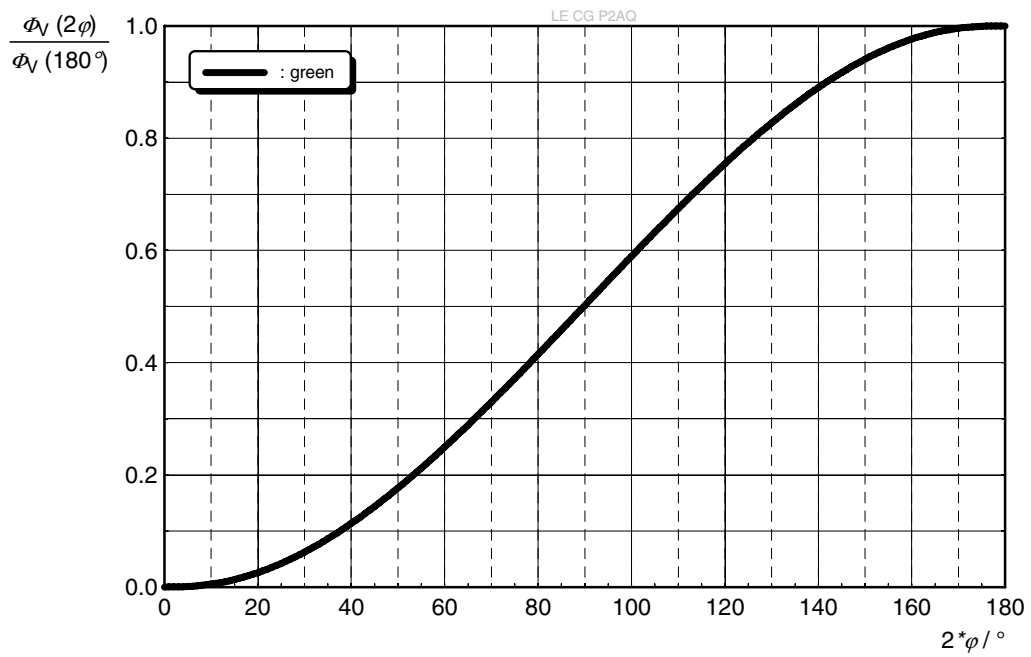

Relative cumulated Luminous Flux ⁴⁾

$\Phi_{Vrel-cum} = f(\lambda); I_F = 6000\text{ mA}; T_J = 25^\circ\text{C}$

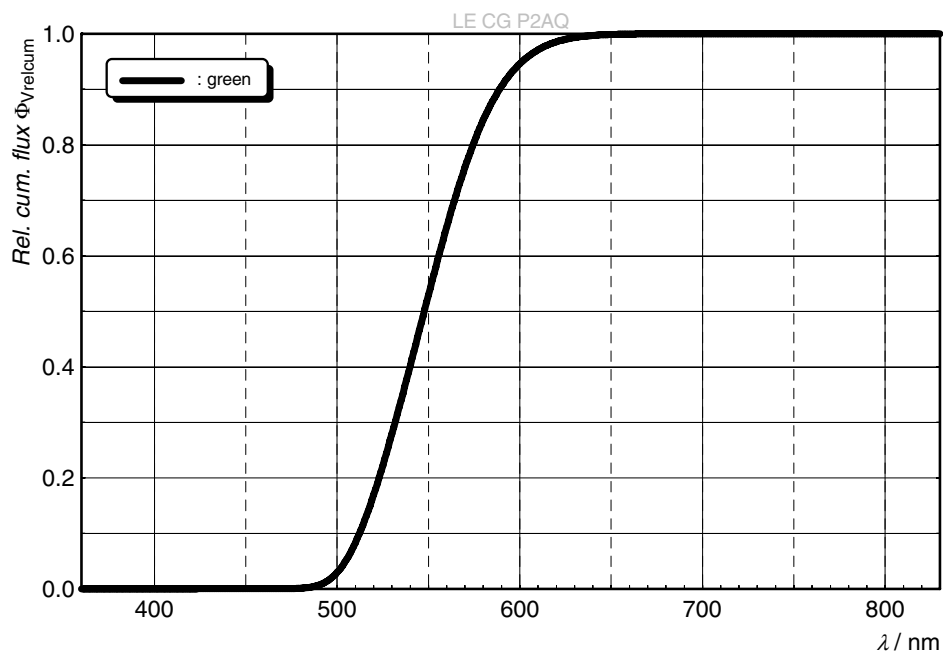

Forward current ⁴⁾

$I_F = f(V_F); T_J = 25\text{ }^\circ\text{C}$

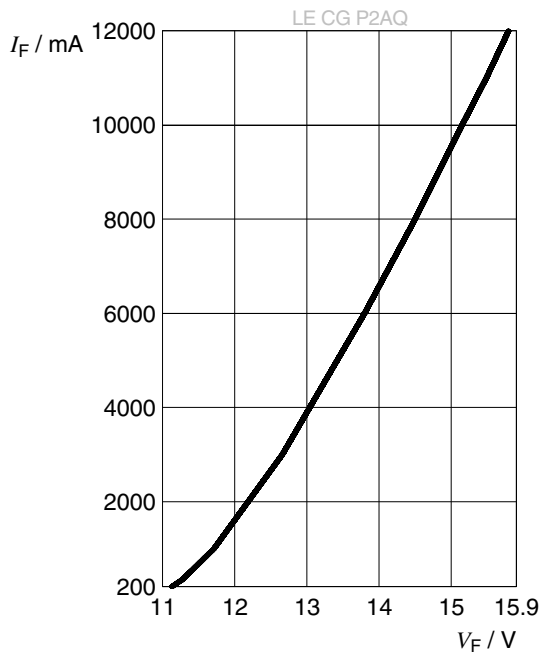

Relative Luminous Flux ^{4), 6)}

$\Phi_V / \Phi_V(6000\text{ mA}) = f(I_F); T_J = 25\text{ }^\circ\text{C}$

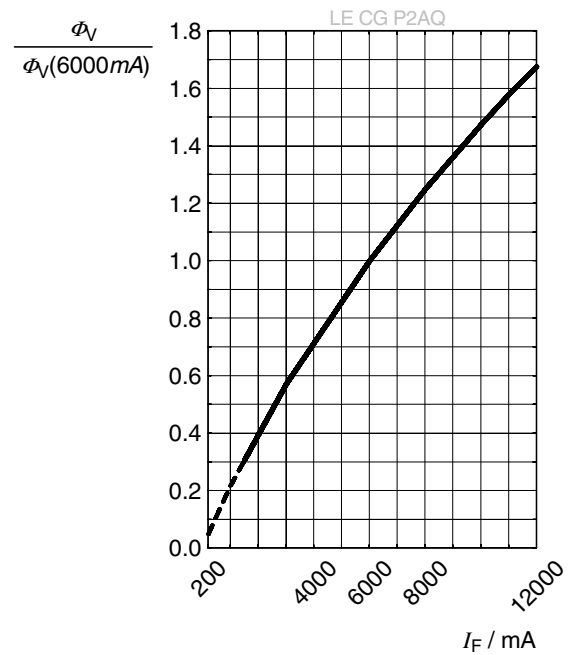

Chromaticity Coordinate Shift ⁴⁾

$\Delta C_x, \Delta C_y = f(I_F); T_J = 25\text{ }^\circ\text{C};$
within $\lambda = 500 \dots 600\text{ nm}$

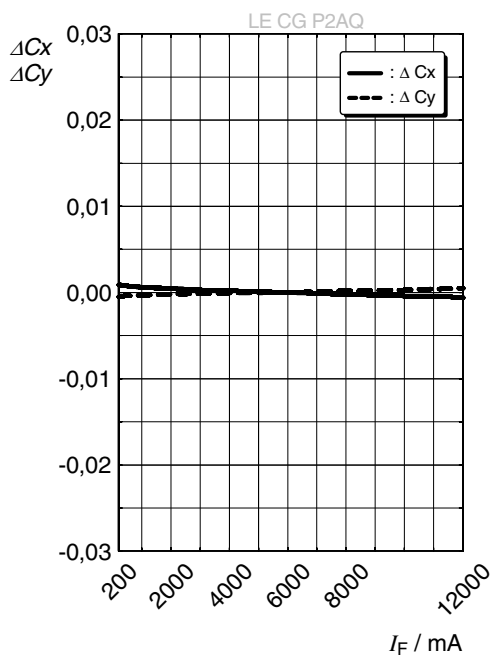

Chromaticity Coordinate Shift ⁴⁾

$\Delta C_x, \Delta C_y = f(I_F); T_J = 25\text{ }^\circ\text{C};$
full spectral range

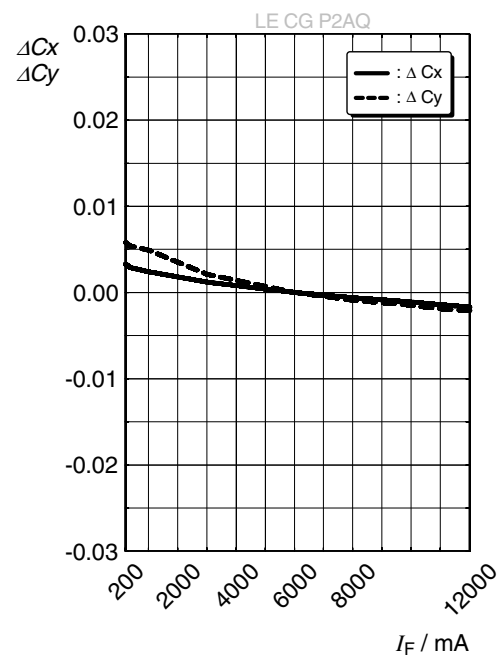

Forward Voltage ⁴⁾

$$\Delta V_F = V_F - V_F(25^\circ\text{C}) = f(T_j); I_F = 6000\text{ mA}$$

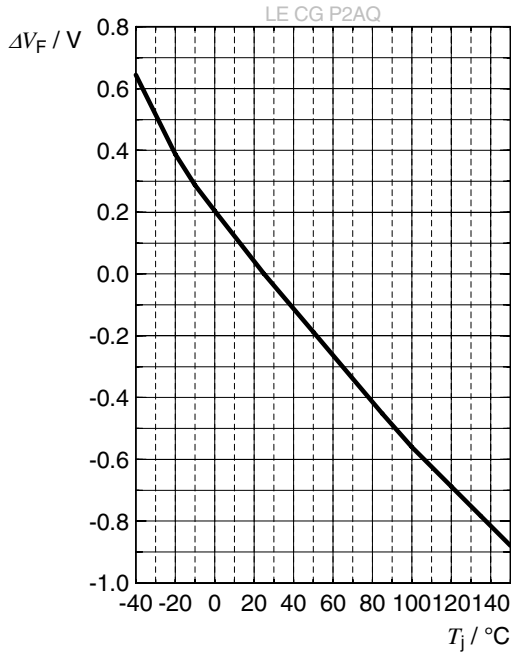

Relative Luminous Flux ⁴⁾

$$\Phi_v / \Phi_v(25^\circ\text{C}) = f(T_j); I_F = 6000\text{ mA}$$

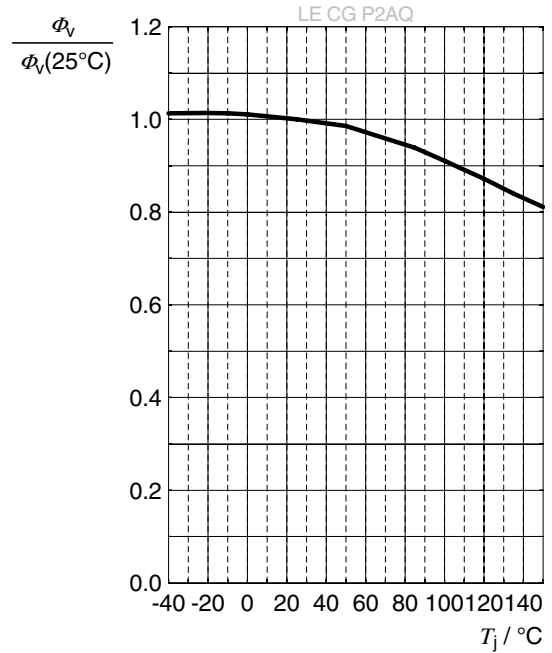

Chromaticity Coordinate Shift ⁴⁾

ΔC_x, ΔC_y = f(T_j); I_F = 12000 mA;
within λ = 500 ... 600 nm

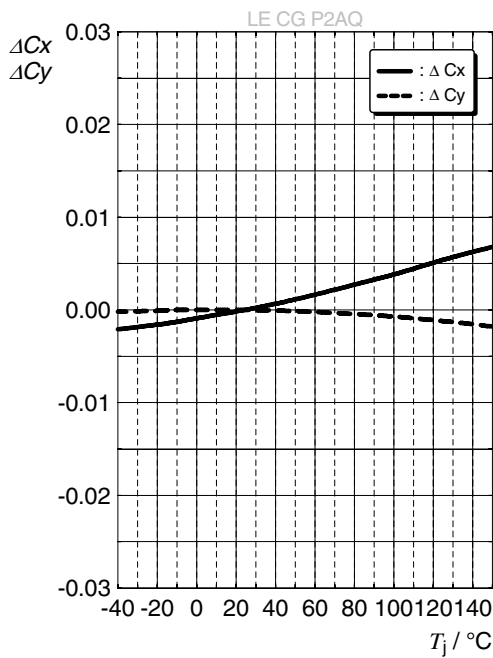

Chromaticity Coordinate Shift ⁴⁾

ΔC_x, ΔC_y = f(T_j); I_F = 12000 mA;
full spectral range

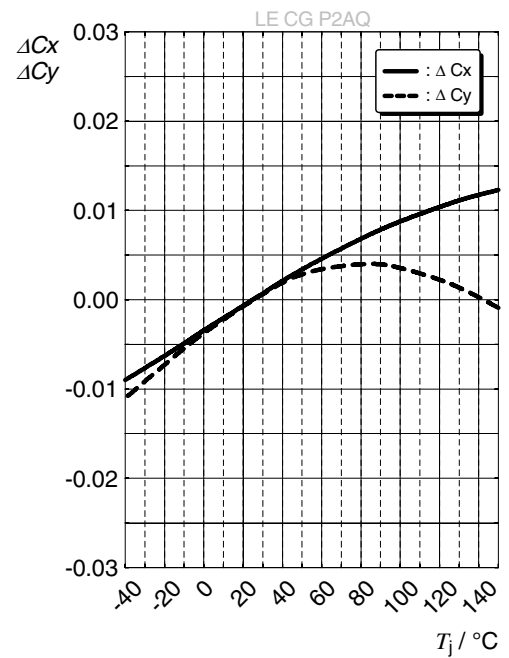

Dimensional Drawing ⁷⁾

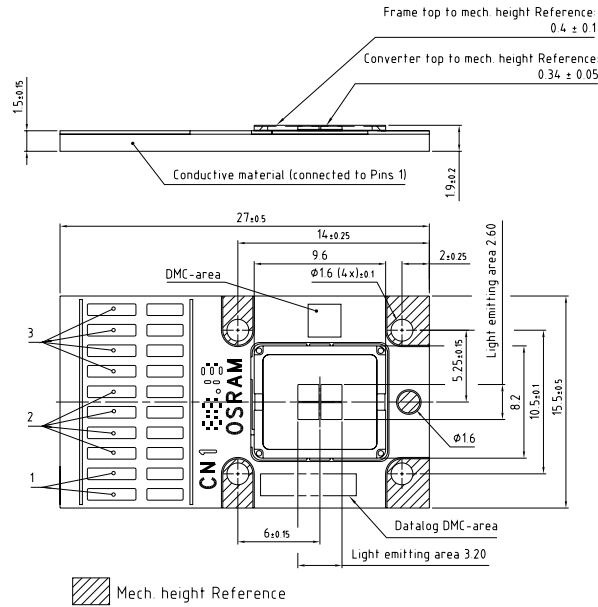

C63062-A4390-A3-04

Further Information:

Approximate Weight: 5,000.0 mg

ESD advice: The device is protected by ESD device which is connected in parallel to the Chip.

Notes: For superior solder joint connectivity results we recommend soldering under standard nitrogen atmosphere.

Package not suitable for any kind of wet cleaning or ultrasonic cleaning.

Connector: Molex Pico-SPOX™ Wire-to-Board Header, Part Number 87438-1043

Recommended mating connector: Molex Pico-SPOX™ Wire-to-Board Housing, Part Number 87439-1000
Crimp Terminal, Part Number 87421-0000

Electrical Internal Circuit

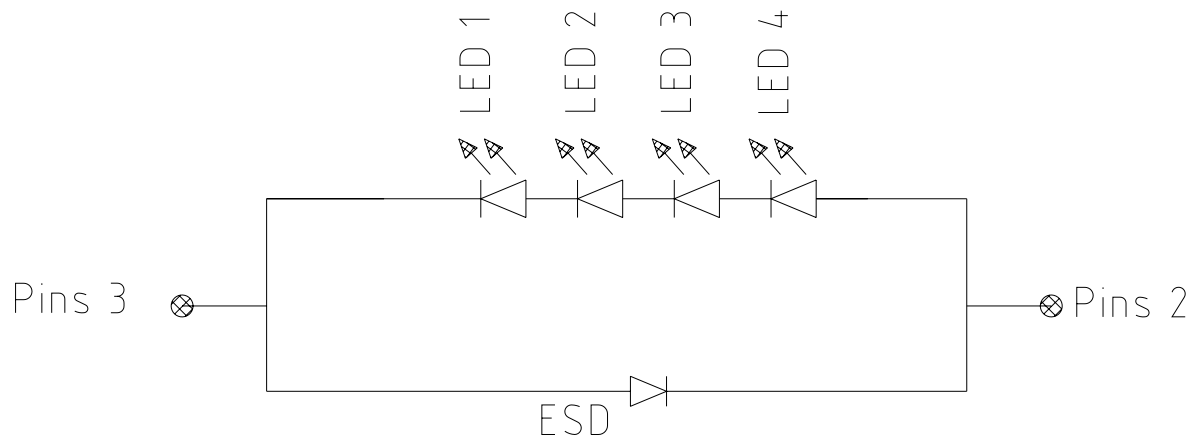

Pins 1: Substrate potential, isolated from Cathode and Anode

Pins 2: Anode

Pins 3: Cathode

Reflow Soldering Profile

Product complies to MSL Level 2 acc. to JEDEC J-STD-020E

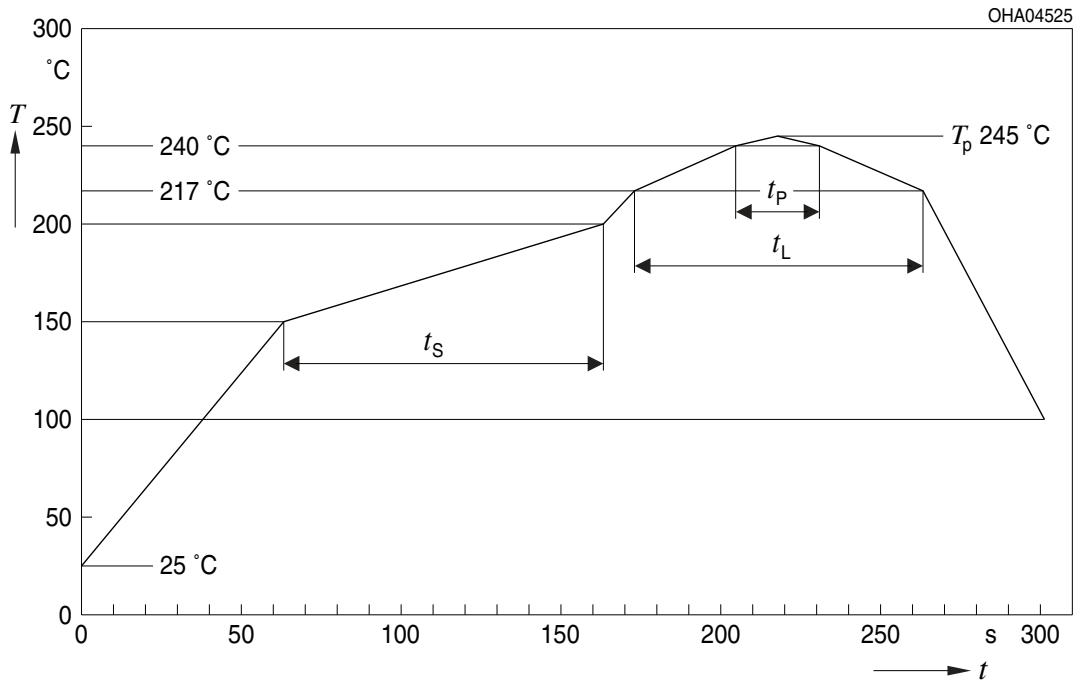

Profile Feature	Symbol	Pb-Free (SnAgCu) Assembly			Unit
		Minimum	Recommendation	Maximum	
Ramp-up rate to preheat ^{*)} 25 °C to 150 °C			2	3	K/s
Time t_s T_{Smin} to T_{Smax}	t_s	60	100	120	s
Ramp-up rate to peak ^{*)} T_{Smax} to T_p			2	3	K/s
Liquidus temperature	T_L		217		°C
Time above liquidus temperature	t_L		80	100	s
Peak temperature	T_p		245	260	°C
Time within 5 °C of the specified peak temperature $T_p - 5$ K	t_p	10	20	30	s
Ramp-down rate* T_p to 100 °C			3	6	K/s
Time 25 °C to T_p				480	s

All temperatures refer to the center of the package, measured on the top of the component
 *) slope calculation DT/Dt : Dt max. 5 s; fulfillment for the whole T-range

Tray ⁷⁾

38 pieces per Tray

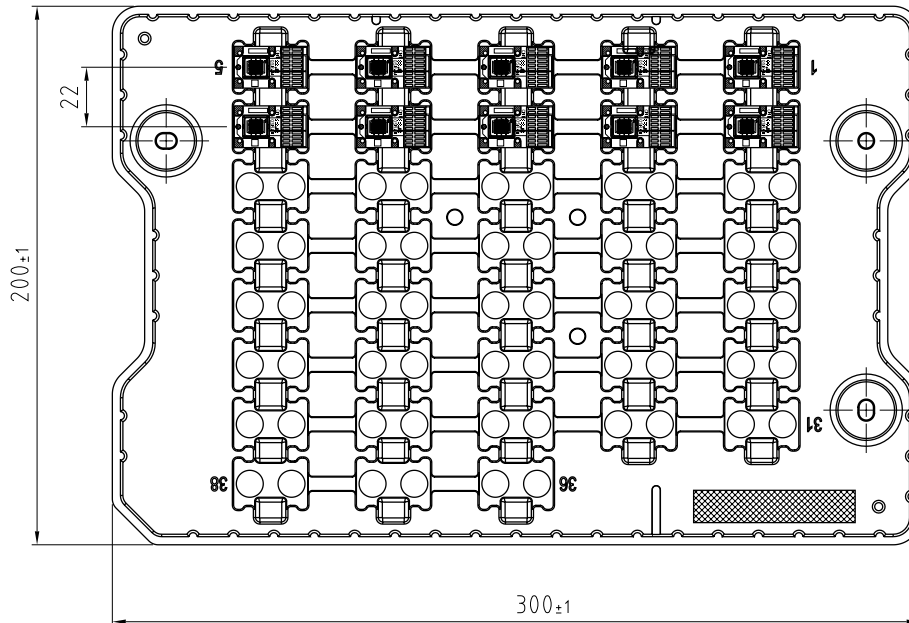

C63062-A4389-B10-01

Barcode-Product-Label (BPL)

OSRAM Opto Semiconductors LX XXXX BIN1: XX-XX-X-XXX-X

RoHS Compliant





(6P) BATCH NO: 1234567890

(1T) LOT NO: 1234567890 (9D) D/C: 1234

(X) PROD NO: 123456789(Q)QTY: 9999 (G) GROUP: XX-XX-X-X

ML Temp ST
X XXX °C X

Pack: RXX
DEMY XXX
X_X123_1234.1234 X

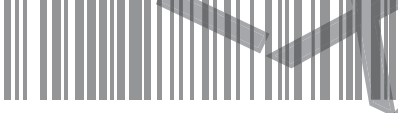

OHA04563



Barcode-Tray-Label (BTL)

LE xxx xxx Group: xxxx-xxxx-xxxx

Data Matrix Code

xxxx BIN

MATERIAL: Material Number Batch Batch Number BIN: xxxx



OHA02684_1

Schematic Transportation Box ⁷⁾

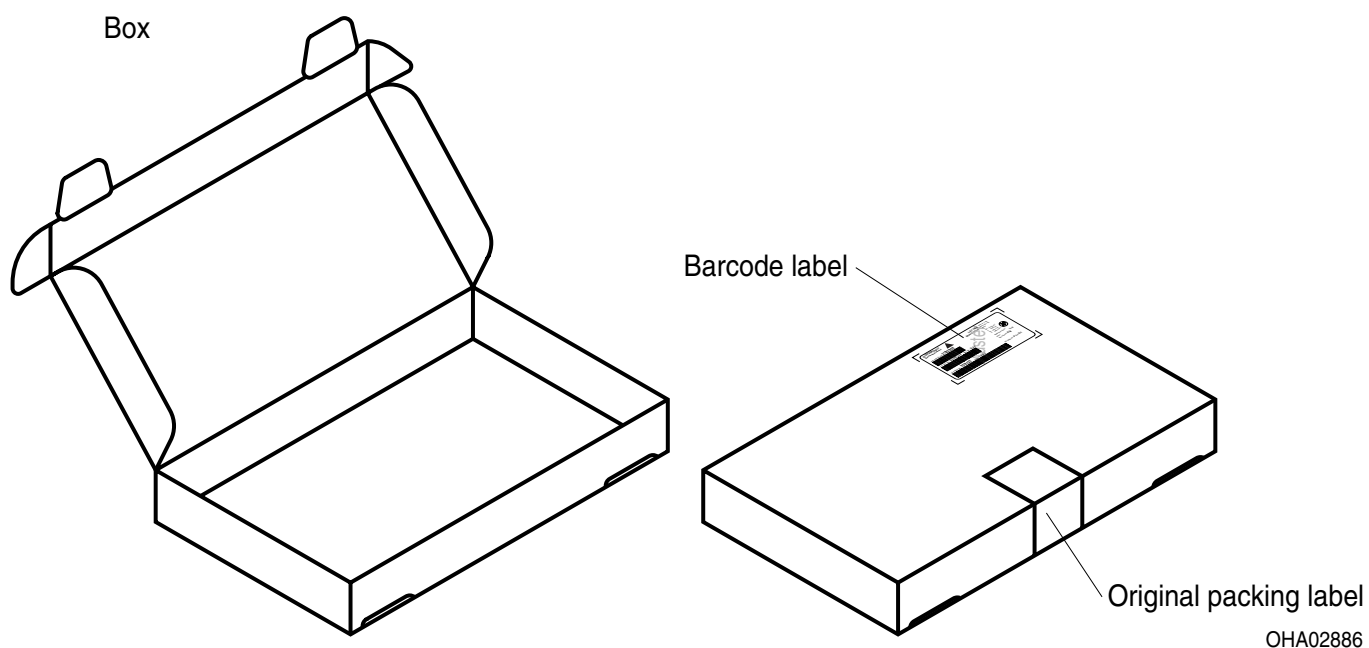

Dimensions of Transportation Box

Width	Length	Height
333 ± 5 mm	218 ± 5 mm	28 ± 5 mm
337 ± 5 mm	218 ± 5 mm	63 ± 5 mm

Type Designation System

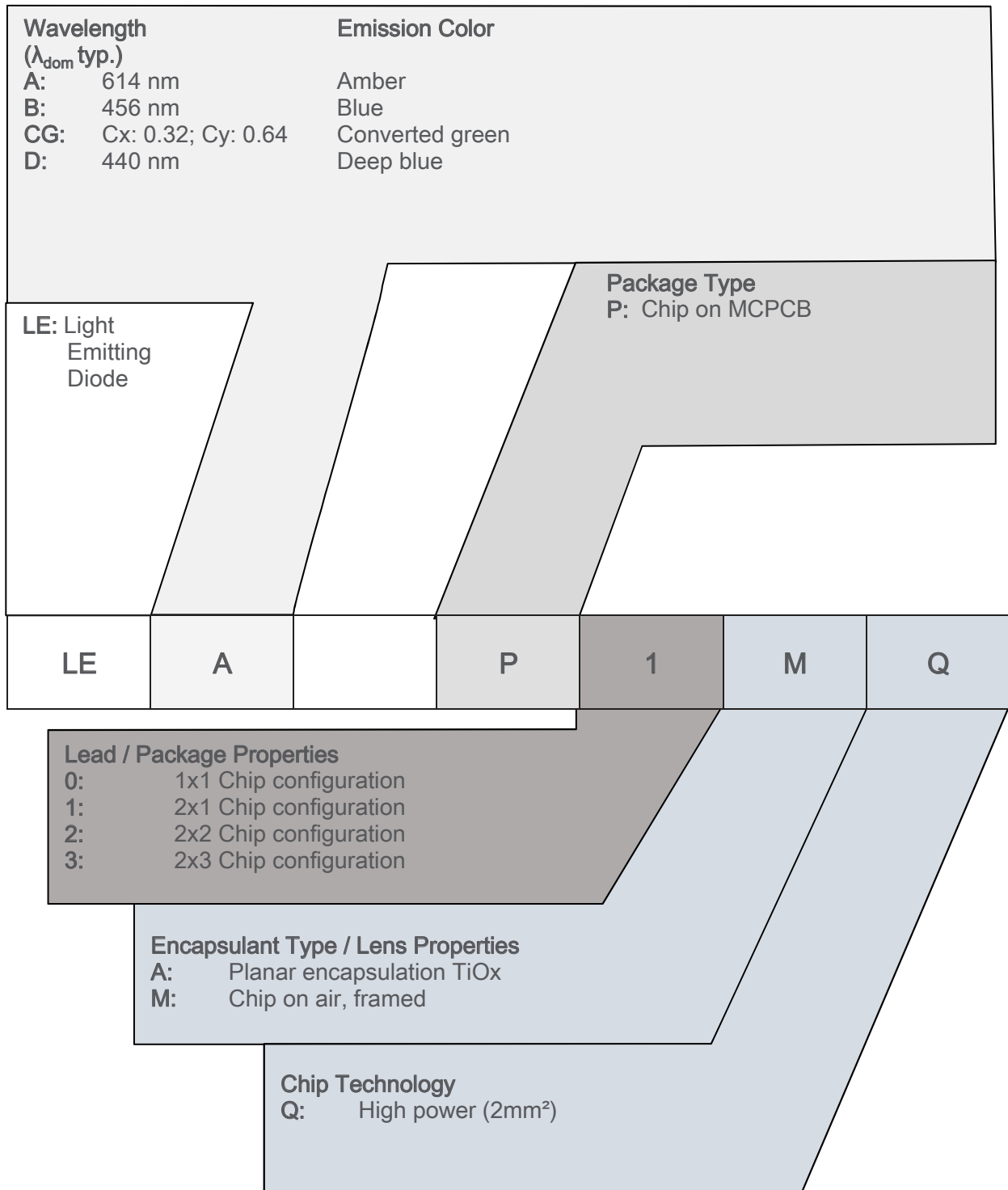

Data Matrix Code Description

The Data Matrix Code bin information is Laser marked during testing

Content: aaaa@bbbb@ccc@dddd@eeee

Data Matrix Code Type: ECC200

a = Luminous Flux (Phiv) [lm] or Radiant Flux (Phie) [W]	(example: 3306)
b = Forward Voltage (Vf) [V]	(example: 3.46)
c = Wavelength (Ldom) [nm]	(example: 618)
d = Color Coordinate Cx	(example: 0.321)
e = Color Coordinate Cy	(example: 0.641)
@: Seperator = Blank	

Notes

The evaluation of eye safety occurs according to the standard IEC 62471:2006 (photo biological safety of lamps and lamp systems). Within the risk grouping system of this IEC standard, the device specified in this data sheet fall into the class **moderate risk (exposure time 0.25 s)**. Under real circumstances (for exposure time, conditions of the eye pupils, observation distance), it is assumed that no endangerment to the eye exists from these devices. As a matter of principle, however, it should be mentioned that intense light sources have a high secondary exposure potential due to their blinding effect. When looking at bright light sources (e.g. headlights), temporary reduction in visual acuity and afterimages can occur, leading to irritation, annoyance, visual impairment, and even accidents, depending on the situation.

Subcomponents of this device contain, in addition to other substances, metal filled materials including silver. Metal filled materials can be affected by environments that contain traces of aggressive substances. Therefore, we recommend that customers minimize device exposure to aggressive substances during storage, production, and use. Devices that showed visible discoloration when tested using the described tests above did show no performance deviations within failure limits during the stated test duration. Respective failure limits are described in the IEC60810.

For further application related information please visit www.osram-os.com/appnotes

Disclaimer

Attention please!

The information describes the type of component and shall not be considered as assured characteristics. Terms of delivery and rights to change design reserved. Due to technical requirements components may contain dangerous substances.

For information on the types in question please contact our Sales Organization.

If printed or downloaded, please find the latest version on the OSRAM OS website.

Packing

Please use the recycling operators known to you. We can also help you – get in touch with your nearest sales office. By agreement we will take packing material back, if it is sorted. You must bear the costs of transport. For packing material that is returned to us unsorted or which we are not obliged to accept, we shall have to invoice you for any costs incurred.

Product and functional safety devices/applications or medical devices/applications

OSRAM OS components are not developed, constructed or tested for the application as safety relevant component or for the application in medical devices.

OSRAM OS products are not qualified at module and system level for such application.

In case buyer – or customer supplied by buyer – considers using OSRAM OS components in product safety devices/applications or medical devices/applications, buyer and/or customer has to inform the local sales partner of OSRAM OS immediately and OSRAM OS and buyer and /or customer will analyze and coordinate the customer-specific request between OSRAM OS and buyer and/or customer.

Glossary

- 1) **Brightness:** Brightness values are measured during a pulse train of 100 ms with a pulse width of 500 μ s and a frequency of 1 kHz, with an internal reproducibility of \pm 8 % and an expanded uncertainty of \pm 11 % (acc. to GUM with a coverage factor of $k = 3$). The peak brightness is calculated according to the pulse duration and frequency.
- 2) **Reverse Operation:** This product is intended to be operated applying a forward current within the specified range. Applying any continuous reverse bias or forward bias below the voltage range of light emission shall be avoided because it may cause migration which can change the electro-optical characteristics or damage the LED.
- 3) **Chromaticity coordinate groups:** Chromaticity coordinates are measured during a pulse train of 100 ms with a pulse width of 500 μ s and a frequency of 1 kHz, with an internal reproducibility of \pm 0,005 and an expanded uncertainty of \pm 0,01 (acc. to GUM with a coverage factor of $k = 3$).
- 4) **Typical Values:** Due to the special conditions of the manufacturing processes of semiconductor devices, the typical data or calculated correlations of technical parameters can only reflect statistical figures. These do not necessarily correspond to the actual parameters of each single product, which could differ from the typical data and calculated correlations or the typical characteristic line. If requested, e.g. because of technical improvements, these typ. data will be changed without any further notice.
- 5) **Forward Voltage:** The forward voltage is measured during a pulse of typical 500 μ s, with an internal reproducibility of \pm 0,05 V and an expanded uncertainty of \pm 0,1 V (acc. to GUM with a coverage factor of $k=3$).
- 6) **Characteristic curve:** In the range where the line of the graph is broken, you must expect higher differences between single devices within one packing unit.
- 7) **Tolerance of Measure:** Unless otherwise noted in drawing, tolerances are specified with \pm 0.1 and dimensions are specified in mm.

Revision History

Version	Date	Change
1.0	2019-08-15	Initial Version
1.1	2019-08-23	Electro - Optical Characteristics (Diagrams)
1.2	2019-09-26	Dimensional Drawing
1.2	2020-02-25	Maximum Ratings Characteristics
1.3	2021-03-26	Ordering Information Brightness Groups Maximum Ratings Dimensional Drawing Electro - Optical Characteristics (Diagrams)
1.4	2021-07-15	Electro - Optical Characteristics (Diagrams) Chromaticity Coordinate Groups

Published by OSRAM Opto Semiconductors GmbH EU RoHS and China RoHS compliant product
Leibnizstraße 4, D-93055 Regensburg
www.osram-os.com © All Rights Reserved.



此产品符合欧盟 RoHS 指令的要求；
按照中国的相关法规和标准，不含有毒有害物质或元素。