

## DATASHEET

### Infrared Receiver Module EAIRMCA1



#### Pin Configuration

1. OUT
2. GND
3. V<sub>CC</sub>

#### Block Diagram

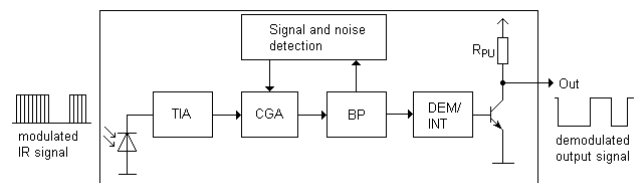

#### Features

- High protection ability against EMI
- Circular lens for improved reception characteristics
- Available for various carrier frequencies
- Min burst length: 10 cycles
- Min gap length: 14 cycles
- Low operating voltage and low power consumption
- High immunity against ambient light
- High immunity against TFT backlight
- Long reception range
- High sensitivity
- Pb free and RoHS compliant
- Compliance with EU REACH
- Compliance Halogen Free (Br <900 ppm, Cl <900 ppm, Br+Cl < 1500 ppm)

#### Description

- The EAIRMCA1 devices are DIP type infrared receivers which have been developed and designed by using the latest IC technology.
- The PIN diode and preamplifier are assembled onto a lead frame and molded into a black epoxy package which operates as an IR filter. The demodulated output signal can directly be decoded by a microprocessor.

#### Applications

- AV equipment such as TV, VCR, DVD, CD, MD, etc.
- Short pause time protocols
- Toy applications
- CATV set top boxes
- Multi-media Equipment
- Other devices using IR remote control

**Application Circuit**

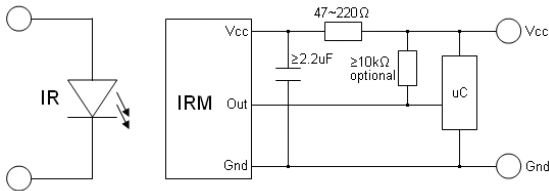

The RC Filter must be connected as close as possible to Vcc and GND pins.

**Parts Table**

Model No.	Carrier Frequency
EAIRMCA1	38 kHz

**Absolute Maximum Ratings (T<sub>a</sub>=25°C)**

Parameter	Symbol	Rating	Unit
Supply Voltage	Vcc	6	V
Operating Temperature	Topr	-20 ~ +80	°C
Storage Temperature	Tstg	-40 ~ +85	°C
Soldering Temperature <sup>*1</sup>	Tsol	260	°C

<sup>\*1</sup> 4mm from mold body for less than 5 seconds

**Electro-Optical Characteristics (Ta=25°C, Vcc=3V)**

Parameter	Symbol	MIN.	TYP.	MAX.	Unit	Condition
Current consumption	I <sub>CC</sub>	---	1.0	1.2	mA	No input signal
Supply voltage	V <sub>CC</sub>	2.7	-	5.5	V	
Peak wavelength	λ <sub>p</sub>	---	940	---	nm	
Reception range	L <sub>0</sub>	14	---	---	m	See chapter ,Test method'
	L <sub>45</sub>	6	---	---		
Half angle(horizontal)	φ <sub>h</sub>	---	±50	---	deg	
Half angle(vertical)	φ <sub>v</sub>	---	±50	---	deg	
High level pulse width	T <sub>H</sub>	400	---	800	μs	Test signal according to figure 1
Low level pulse width	T <sub>L</sub>	400	---	800	μs	
High level output voltage	V <sub>OH</sub>	V <sub>CC</sub> -0.4	---	---	V	
Low level output voltage	V <sub>OL</sub>	---	0.2	0.5	V	I <sub>SINK</sub> ≤ 2mA

**Test method**

The specified electro-optical characteristics are valid under the following conditions.

1. Measurement environment  
A place without extreme light reflections.
2. External light  
The environment contains an ordinary, white fluorescent lamp without high frequency modulation. The color temperature is 2856K and the illumination at the IR receiver is less than 10 Lux ( $E_v \leq 10\text{Lux}$ ).
3. Standard transmitter  
The test transmitter is calibrated by using the circuit shown in figure 2. The radiation intensity of the transmitter is adjusted until  $V_o=400\text{mVp-p}$ . Both, the test transmitter and the photo diode, have a peak wavelength of 940nm. The photo diode for calibration is PD438B ( $\lambda_p=940\text{nm}$ ,  $V_r=5\text{V}$ ).
4. The measurement system is shown in Fig.-3

Fig.-1 Transmitter Wave Form

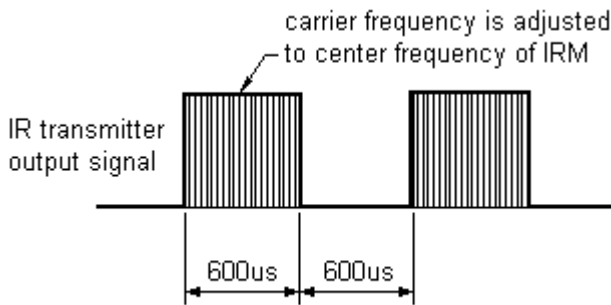

D.U.T output Pulse

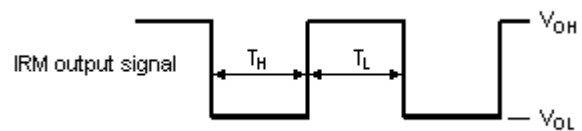

Fig.-2 standard transmitter calibration

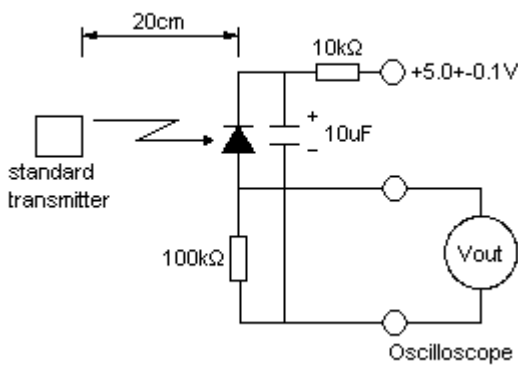
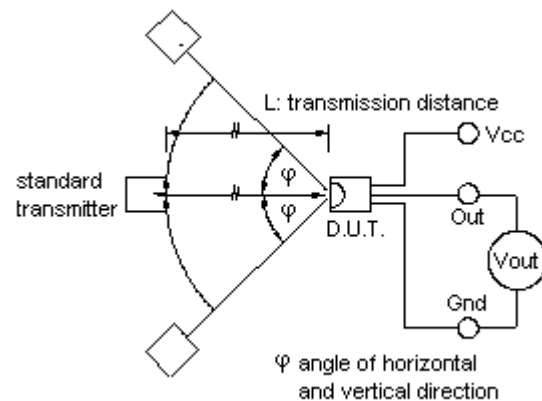

Fig.-3 Measuring System



**Typical Electro-Optical Characteristic Curves**

Fig.-4 Relative Spectral Sensitivity vs. Wavelength

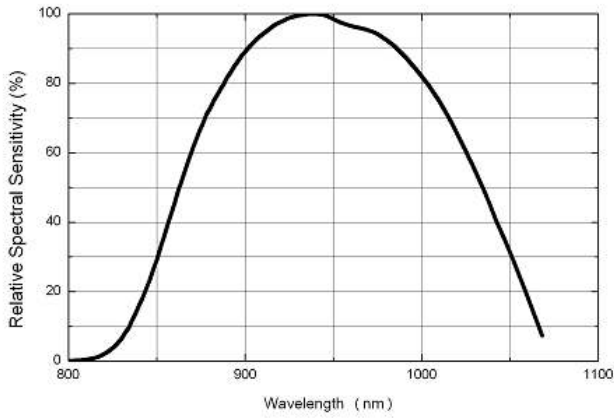

Fig.-5 Relative Sensitivity vs. Angle

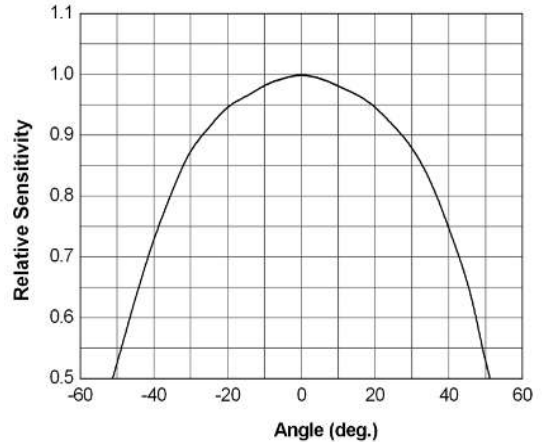

Fig.-6 Output Pulse Width vs. Transmission Distance

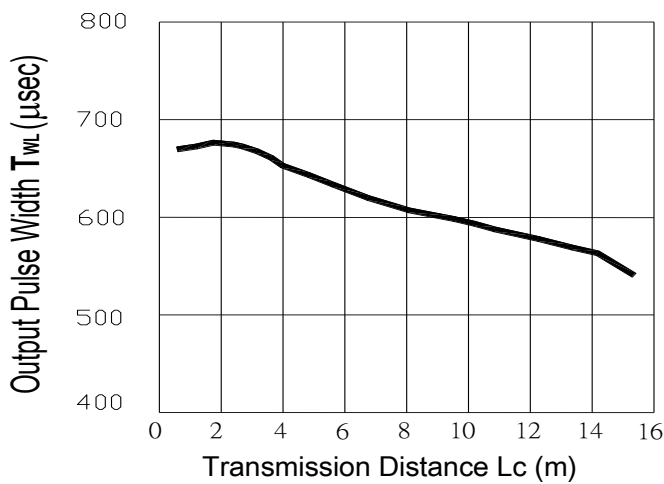

Fig.-7 Relative Transmission Distance vs. Supply Voltage

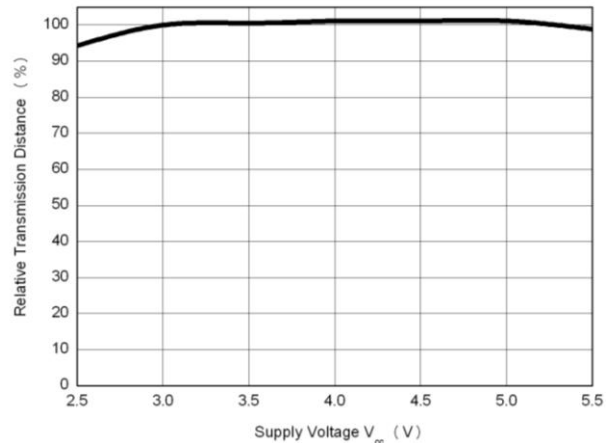
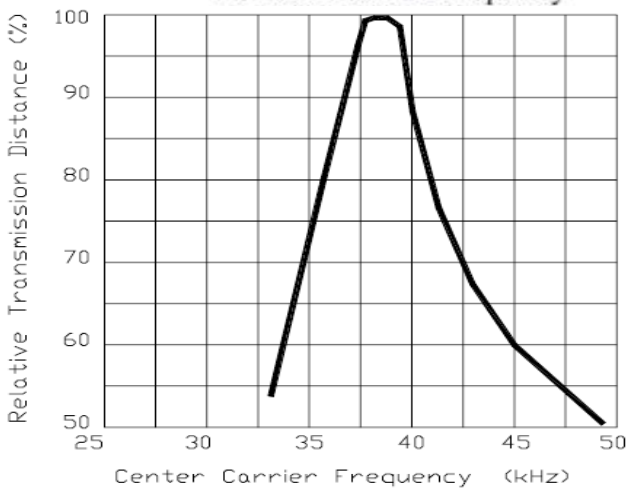
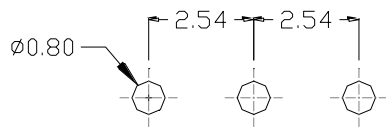
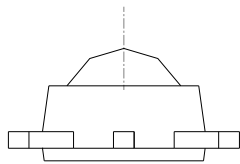
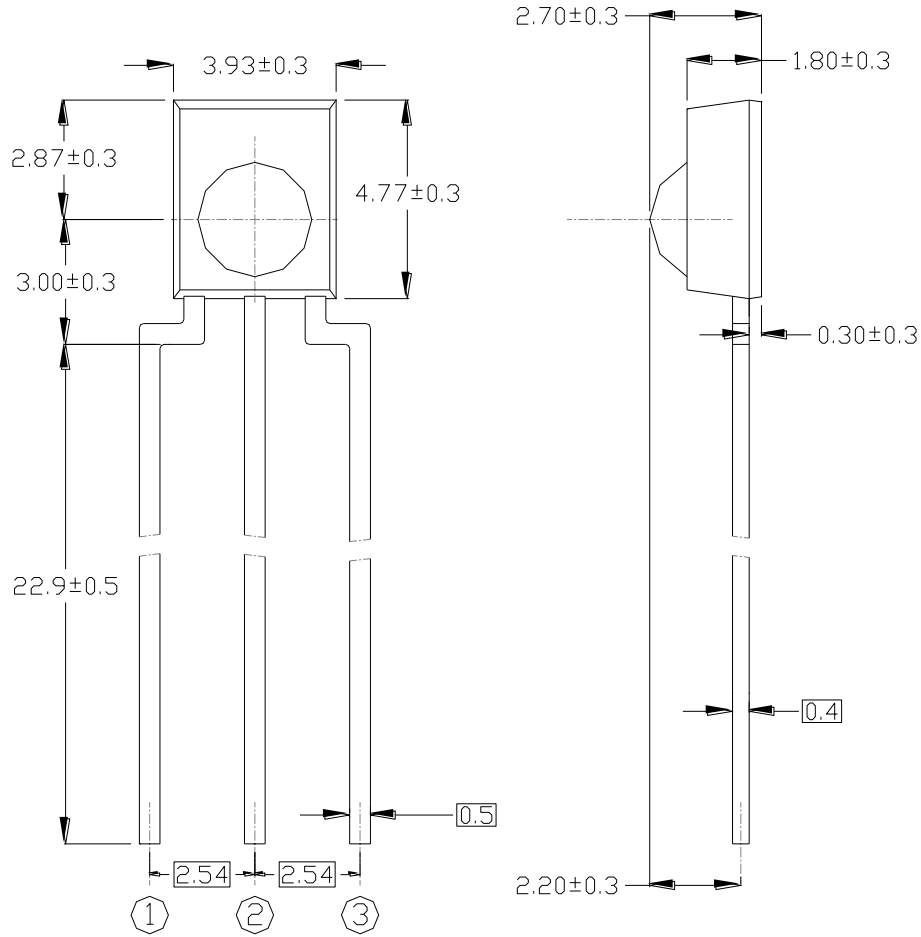

Fig.-8 Relative Transmission Distance vs. Center Carrier Frequency



**Package Dimensions**  
 (Dimensions in mm)



- ① Vout
- ② GND
- ③ Vcc

**Notes:**  
 Tolerances unless mentioned  $\pm 0.3$ mm. Unit: mm

**Code information**

Protocol	Suitable	Protocol	Suitable
JVC	No	RCA	No
Matsushita	Yes	Sharp	Yes
Mitsubishi	No	Sony 12 Bit	Yes
NEC	Yes	Sony 15 Bit	No
RC5	Yes	Sony 20Bit	No
RC6	Yes	Toshiba	Yes
RCMM	No	Zenith	Yes
RCS-80	No	Continuous Code	No

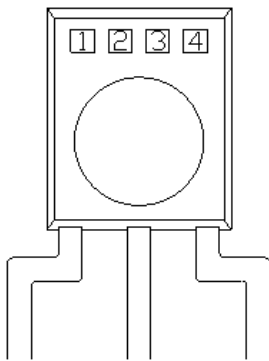
**Device Marking****Notes**

- 1 denotes Year code
- 2 denotes Month code
- 3 denotes Device number
- 4 denotes Carrier frequency

**Packing Quantity**

- 1500 pcs / Box
- 10 Boxes / Carton

## DISCLAIMER

1. Above specification may be changed without notice. Everlight Americas will reserve authority on material change for above specification.
2. When using this product, please observe the absolute maximum ratings and the instructions for use outlined in these specification sheets. Everlight Americas assumes no responsibility for any damage resulting from use of the product which does not comply with the absolute maximum ratings and the instructions included in these specification sheets.
3. These specification sheets include materials protected under copyright of Everlight Americas. Reproduction in any form is prohibited without the specific consent of Everlight Americas.