

## RGBX-M

~30° medium beam optimized for Osram Ostar-SMT RGB. Assembly with colour mixing sublens and holder.

### TECHNICAL SPECIFICATIONS:

Dimensions	Ø 30.0 mm
Height	28 mm
Fastening	glue
ROHS compliant	yes ⓘ

### MATERIAL SPECIFICATIONS:

Component	Type	Material	Colour	Finish
RGBX-SS	Single lens	PMMA		
RGBX-O-SMT-HLD	Holder	PC		
RGBX-M-SUB	Sublens	PC		



### ORDERING INFORMATION:

Component		Qty in box	MOQ	MPQ	Box weight (kg)
CP10766_RGBX-M	Single lens	486		54	7.5
» Box size: 480 x 280 x 300 mm					

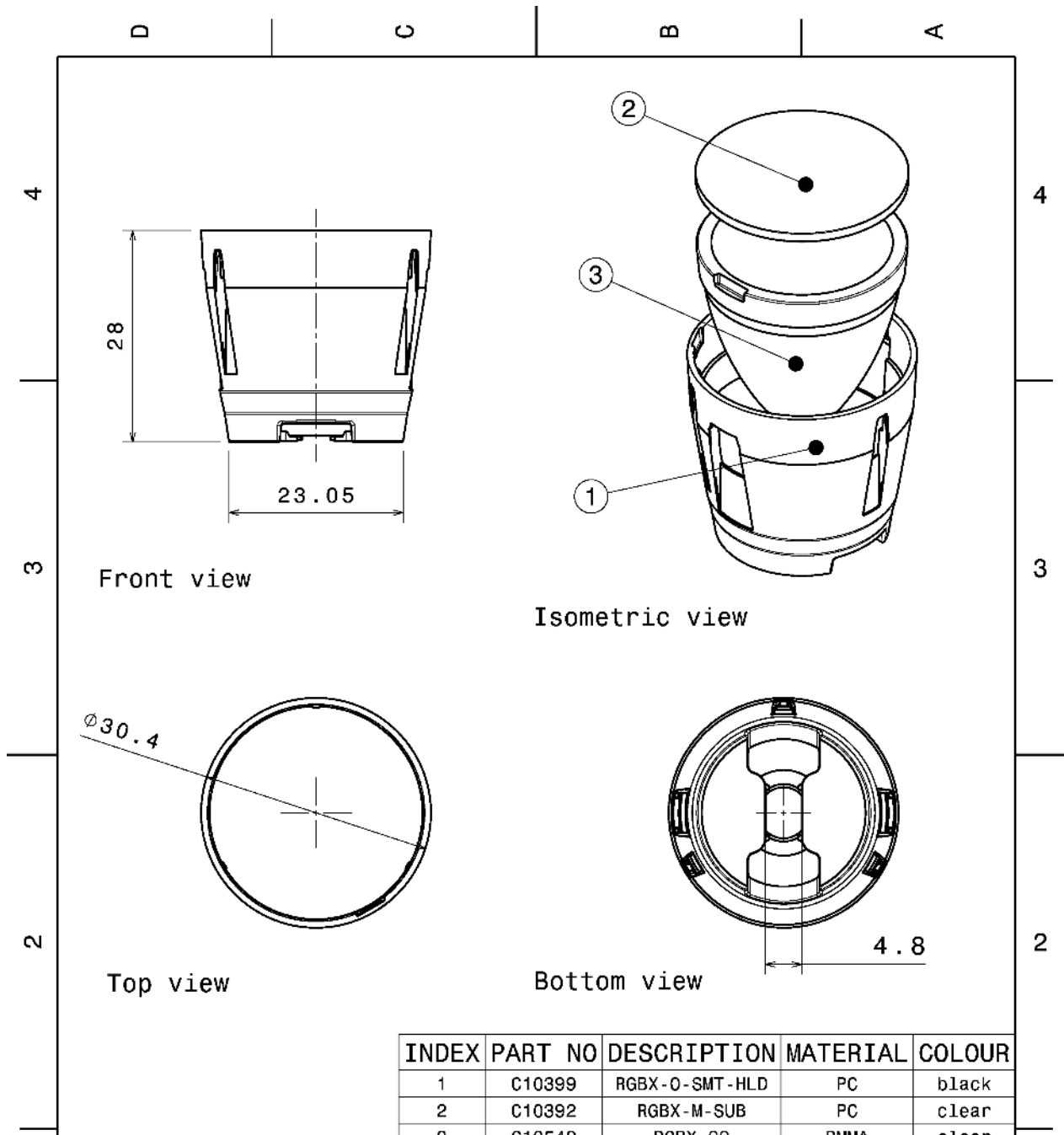

INDEX	PART NO	DESCRIPTION	MATERIAL	COLOUR
1	C10399	RGBX-0-SMT-HLD	PC	black
2	C10392	RGBX-M-SUB	PC	clear
3	C10542	RGBX-SS	PMMA	clear

Tolerances if not otherwise shown  
According to DIN ISO 2768-1  
Linear measures: class C  
According to DIN ISO 2768-2  
Form and position: class L

**LEDiL**

Ledil Oy  
Salorankatu 10  
FIN 24240 SALO  
Finland

THIRD ANGLE PROJECTION:

DRAWING TITLE

CP10766\_RGBX-M

This drawing is the property of LEDiL Oy. It may not be reproduced, copied or communicated without a written agreement with LEDiL Oy.

SIZE PART NUMBER

A4

CP10766

SCALE 3:2 WEIGHT 12,7 g SHEET 1/1

#### PHOTOMETRIC DATA (MEASURED):

##### LUMILEDS

LED LUXEON C  
 FWHM 44.0°  
 Efficiency 67 %  
 Peak intensity 1.000 cd/lm  
 LEDs/each optic 4  
 Light colour RGBW  
 Required components:

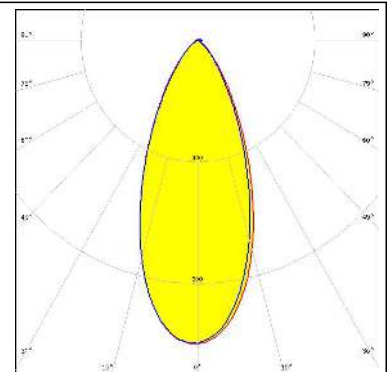
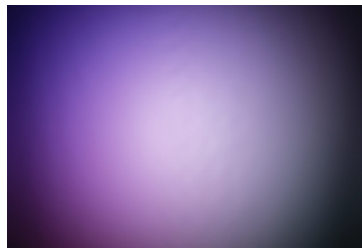

##### LUMILEDS

LED LUXEON CZ  
 FWHM 42.0°  
 Efficiency 73 %  
 Peak intensity 1.200 cd/lm  
 LEDs/each optic 4  
 Light colour RGBW  
 Required components:

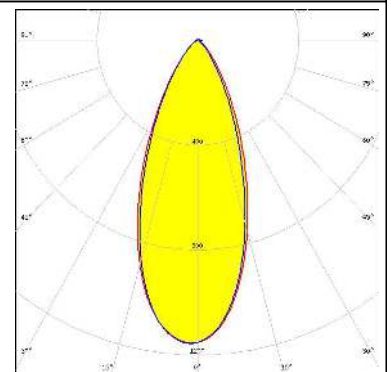
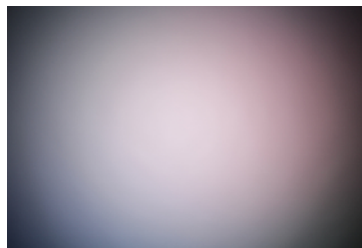

##### LUMINUS

LED SBM-40-RGBW  
 FWHM 39.0°  
 Efficiency 73 %  
 Peak intensity 1.300 cd/lm  
 LEDs/each optic 1  
 Light colour White  
 Required components:

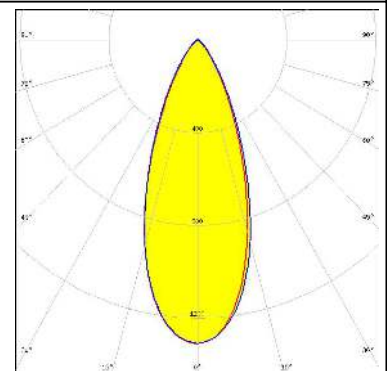
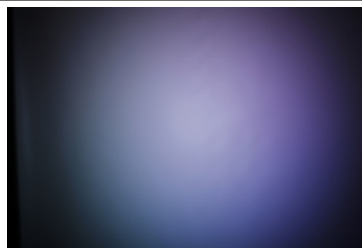

##### OSRAM

Opto Semiconductors  
 LED Ostar-SMT RGB  
 FWHM 30.0°  
 Efficiency 70 %  
 Peak intensity cd/lm  
 LEDs/each optic 1  
 Light colour White  
 Required components:

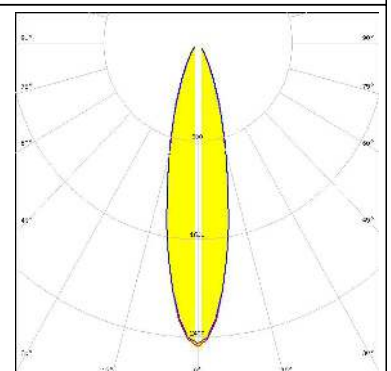

### GENERAL INFORMATION:

NOTE: The typical beam angle will be changed by different color, chip size and chip position tolerance. The typical total beam angle is the full angle measured where the luminous intensity is half of the peak value.

### MATERIALS:

As part of our continuous research and improvement processes, and to ensure the best possible quality and availability of our products, LEDiL reserves the right to change material grades without notice.

### PRODUCT DATA USER AGREEMENT AND DISCLAIMER:

The measured data in the provided downloadable LEDiL Product Datasheets and Mechanical 2D-Drawings is rounded and provided as reference for planning. LEDiL Oy's optical specifications have been verified by conducting performance testing of the products in accordance with the company's quality system. The reported data are averaged results of multiple measurements with typical variation. LEDiL Oy reserves the right to without prior notification make changes and improvements to its products.

LEDiL Oy assumes neither warranty, nor guarantee nor any other liability of any kind for the contents and correctness of the provided data. The provided data has been generated with highest diligence but the provided data may in reality not represent the complete possible variation range of all intrinsic parameters. Therefore, in certain cases a deviation from the provided data could occur.

LEDiL Oy reserves the right to undertake technical changes of its products without further notification which could lead to changes in the provided data. LEDiL Oy assumes no liability of any kind for the possible deviation from any provided data or any other damage resulting from the usage of the provided data.

The user agrees to this disclaimer and user agreement with the download or usage of the provided files.

#### LEDiL Oy

Joensuunkatu 13  
FI-24240 SALO  
Finland

#### LEDiL Inc.

228 West Page Street  
Suite D  
Sycamore IL 60178  
USA

#### Local sales and technical support

[www.ledil.com/  
where\\_to\\_buy](http://www.ledil.com/where_to_buy)

#### Shipping locations

Salo, Finland  
Hong Kong, China

#### Distribution Partners

[www.ledil.com/  
where\\_to\\_buy](http://www.ledil.com/where_to_buy)