



Features

Package	Metal board / COB (Chip on Board) type Outer dimension: 26.5 x 20.0 x 2.1mm (L x W x H)
Product features	<ul style="list-style-type: none"> • Superior in high luminous flux, large current driving and heat dissipation • High reliability to withstand harsh environments • Small light emitting area that is superior for optical design • RoHS compliant

Recommended Applications

- Exterior lighting for automotive and motorcycle (Head lamp, DRL/Day time Running Light, etc.)
- Light source for other equipment requiring high luminance and high current drive

Outline Dimensions

BUA1052A

Unit : mm
 Weight : 4.46g
 Tolerance : ±0.1

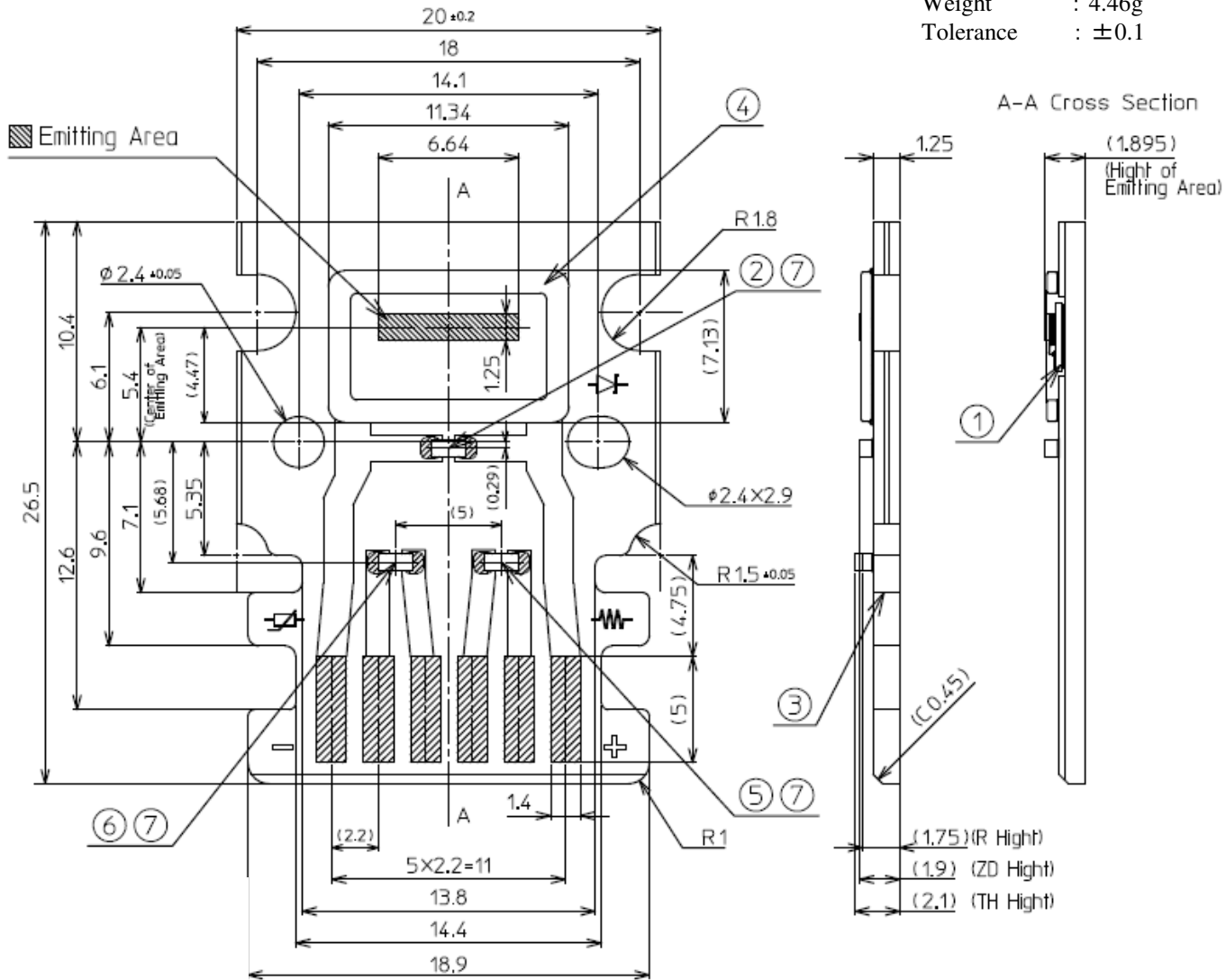

No.	Part name	Qty.
①	White LED Submount	1
②	Protection diode (ZD)	1
③	Metal board	1
④	Ring	1
⑤	Resistor (R)	1
⑥	Thermistor (TH)	1
⑦	Solder	6

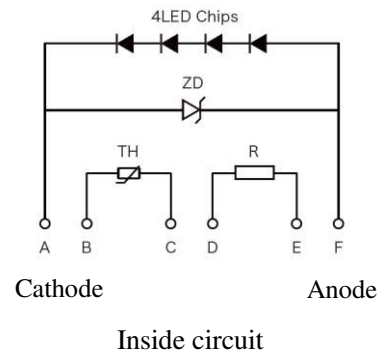

【 Product Overview 】

DIE MATERIAL	InGaN
EMITTING COLOR	White
EMISSION AREA COLOR	Diffused Pale Yellow

【 Absolute Maximum Ratings 】

(Ta=25°C)

ITEM	SYMBOL	MAXIMUM RATINGS	UNITS	
Power Dissipation	P_d	31.5	W	
Forward Current	I_F	200~2,100	mA	
Operating Temperature	T_{opr}	-40 ~ +120	°C	Notes 1
Storage Temperature	T_{stg}	-40 ~ +120	°C	Notes 1
Electro Static Discharge Threshold "HBM"	ESD	±8,000	V	Notes 2
Zener diode Power Dissipation	P_d-ZD	150	mW	
Zener diode Voltage ($I_Z=2mA$)	V_Z	32	V	

Notes1 The range of operating and storage temperature are not taping condition.

Notes2 ESD testing method : EIAJ4701/300(304) Human Body Model (HBM) 1.5kΩ,100pF

【 Thermal Characteristics 】

ITEM	SYMBOL	TYP.	MAX.	UNITS
Thermal resistance 【Junction - the bottom of Cu substrate】	$R_{th(j-s)}$	0.70	1.12	°C/W
Junction Temp. increase ($I_F=1.8A$) 【Junction - the bottom of Cu substrate】	ΔT_j	-	30.24	°C
Junction Temperature	T_j	150		°C
Junction Temperature (1000Hr)	T_j	160		°C
Junction Temperature (Short Term : 100Hr)	T_j	175		°C

【 Electro-Optical Characteristics 】

(Ta=25°C)							
ITEM	SYMBOL	CONDITIONS	MIN.	TYP.	MAX.	UNITS	
Forward Voltage	V _F	I _F = 1800mA	11.3	-	15.0	V	Notes3
Luminous Flux	Φ _v	I _F = 1800mA	1,950	-	3,216	lm	Notes3
Chromaticity Coordinates	x	I _F = 1800mA	-	0.328	-	/	Notes3,4
	y		-	0.344	-		

Note3 Refer to the attached sheets for each sorting chart.

Note4 Chromaticity coordinates ; x and y according to CIE1931.

【 Electro Characteristics of NTC Thermistor 】

(Ta=25°C)						
ITEM	CONDITIONS	MIN.	TYP.	MAX.	UNITS	
Maximum Current	Thermistor Temp. = 25°C	-	-	80	μA	Notes5
Resistance Value	Thermistor Temp. = 25°C	-	150k±3%	-	Ω	Notes5

Note5 Maximum current : Current value to which the NTC thermistor unit generates heat by 1°C.
The current value of 1/10 or less is recommended when used for the temperature detection.

【 Sorting Chart For Forward Voltage : V_F 】

LEDs shall be sorted out into the following chart.

Forward Voltage V _F (V)		Conditions
MIN.	MAX.	
11.3	15.0	I _F =1800mA

Notes

Tolerance On Forward Voltage : ±0.1V

Measurement Timing : Instantly After Lighting

【 Sorting Chart For Luminous Flux : Φ_v 】

LEDs shall be sorted out into the following chart and each rank shall be packed separately for shipping.

Rank	Luminous Flux Φ_v (lm)		Conditions
	MIN.	MAX.	
A	1,950	2,155	$I_F=1800\text{mA}$ $T_a=25^\circ\text{C}$
B	2,155	2,382	
C	2,382	2,632	
D	2,632	2,909	
E	2,909	3,216	

Notes

Tolerance On Luminous Flux : $\pm 7\%$

Measurement Timing : Instantly After Lighting
(50msec)

【 Resistance Value Table 】

Resistance is mounted as the below table according to the rank of the luminous flux of the LED.

Rank	Resistance Value (Ω) $T_a = 25^\circ\text{C}$
A	0.2k Ω
B	0.6k Ω
C	1.0k Ω
D	1.6k Ω
E	3.3k Ω

【 Sorting Chart For Chromaticity Coordinates : x, y 】

LEDs shall be sorted out into the following chart and each rank shall be packed separately for shipping.

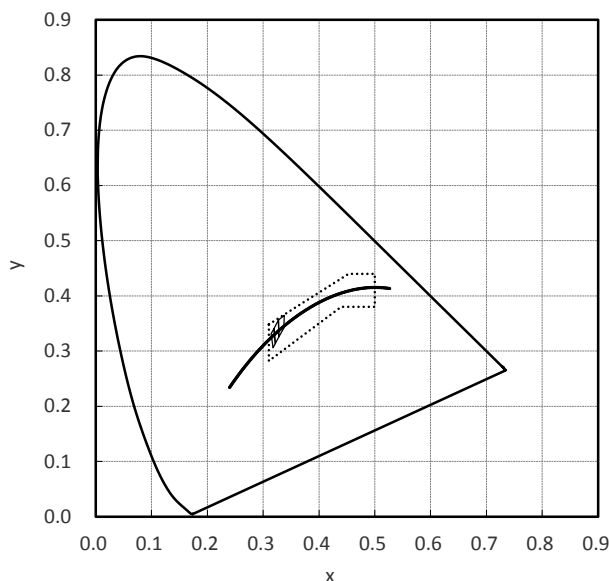
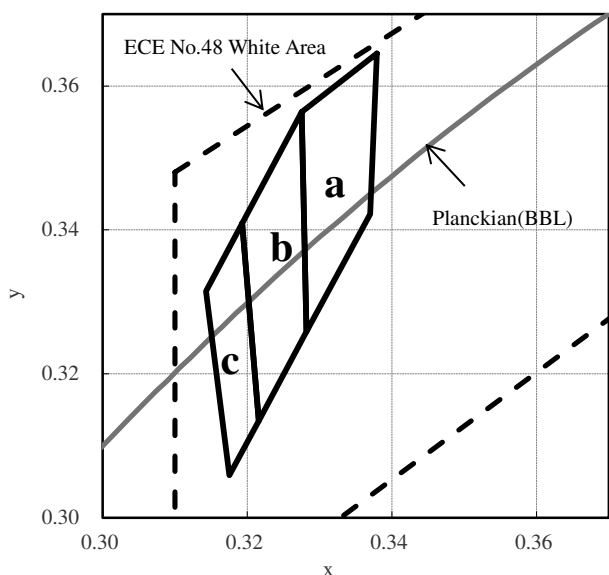

($I_F=1000\text{mA}$ $T_a=25^\circ\text{C}$)

Rank	Cx	Cy	Cx	Cy	Cx	Cy	Cx	Cy
a	0.3379	0.3645	0.3370	0.3422	0.3282	0.3259	0.3275	0.3564
b	0.3275	0.3564	0.3282	0.3259	0.3216	0.3135	0.3193	0.3409
c	0.3193	0.3409	0.3216	0.3135	0.3175	0.3059	0.3143	0.3315

Notes

Tolerance On Chromaticity Coordinates : ± 0.005

Measurement Timing : Instantly After Lighting (50msec)

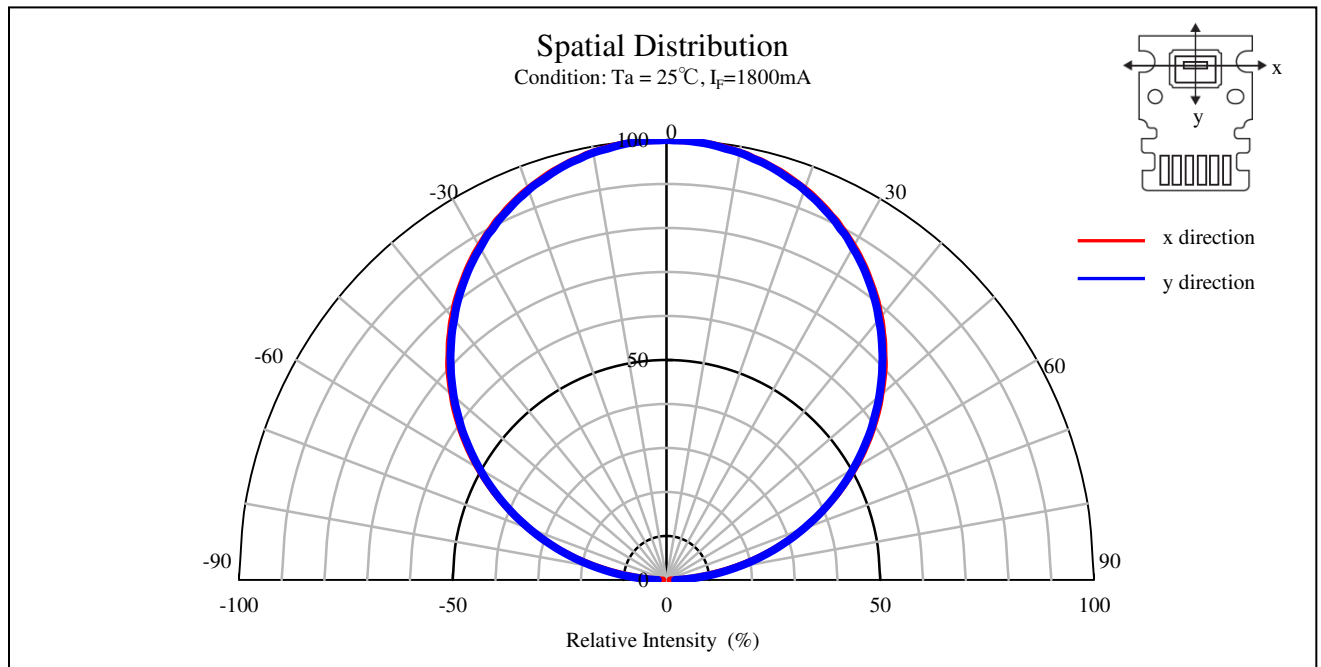
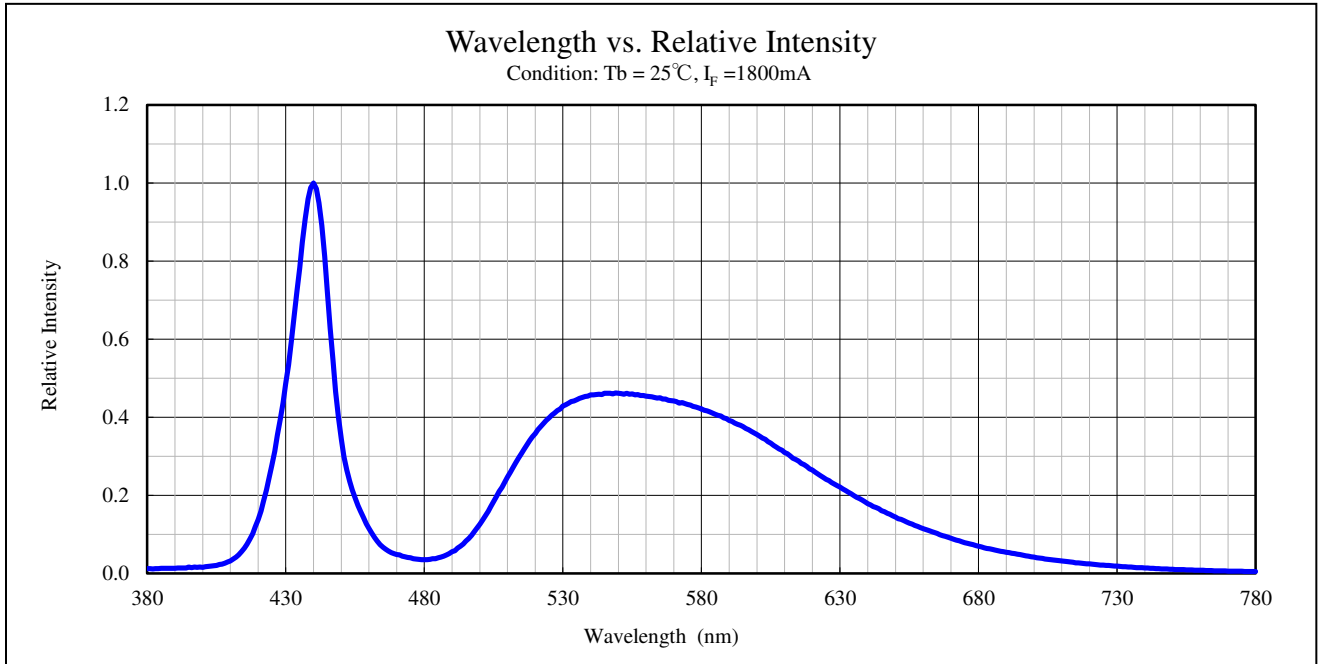

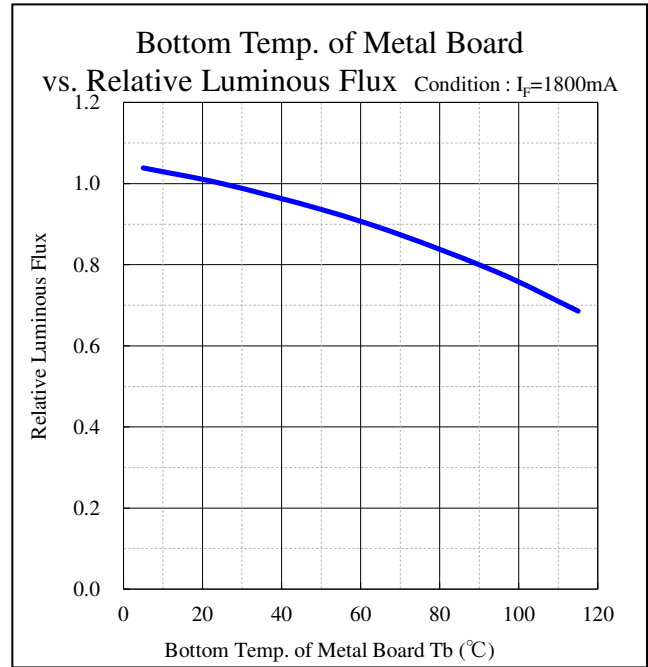
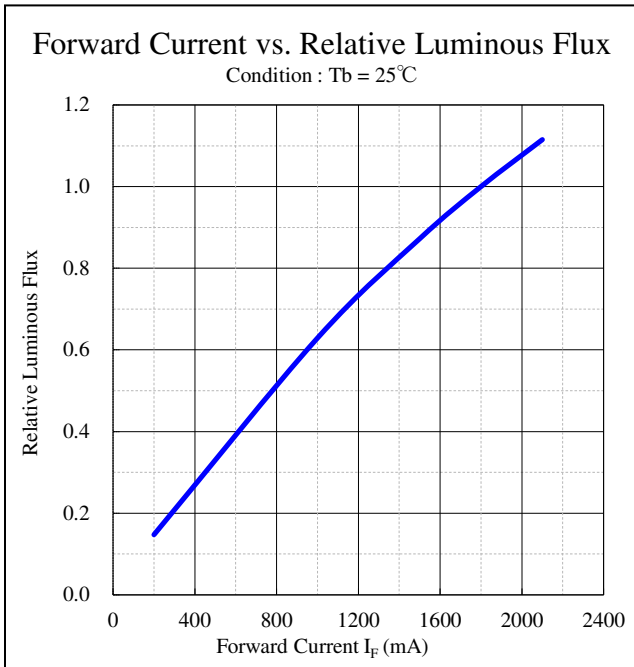
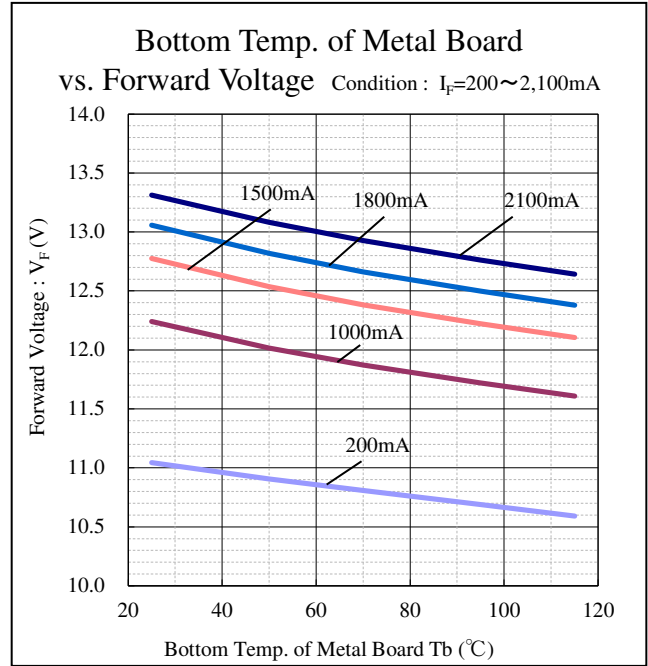
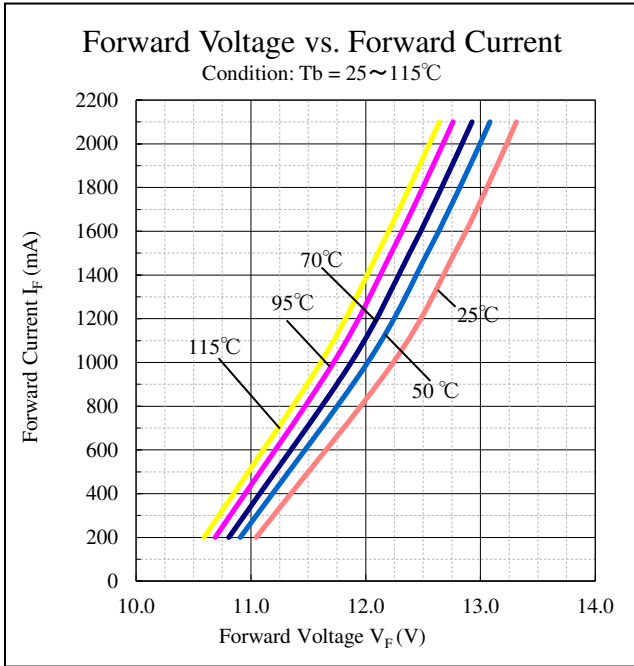

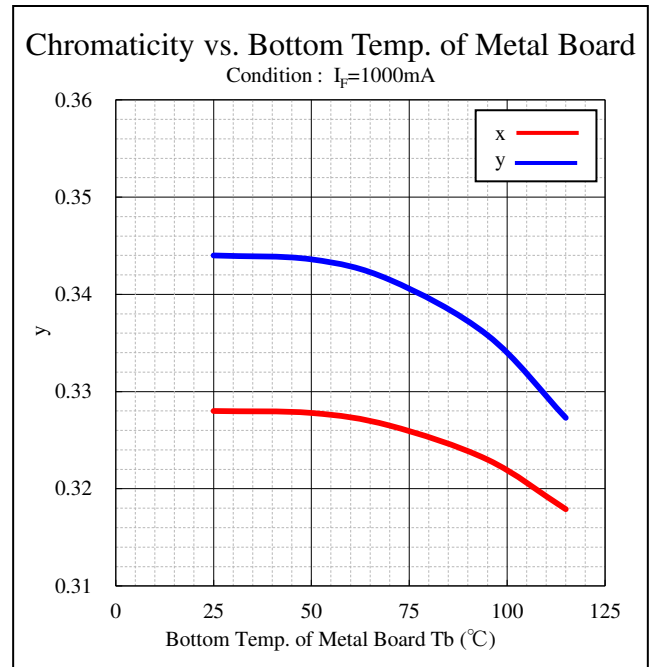
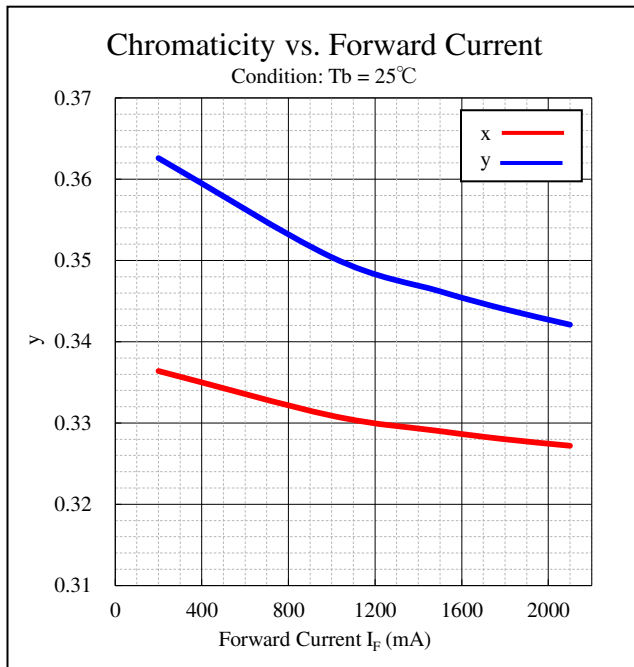
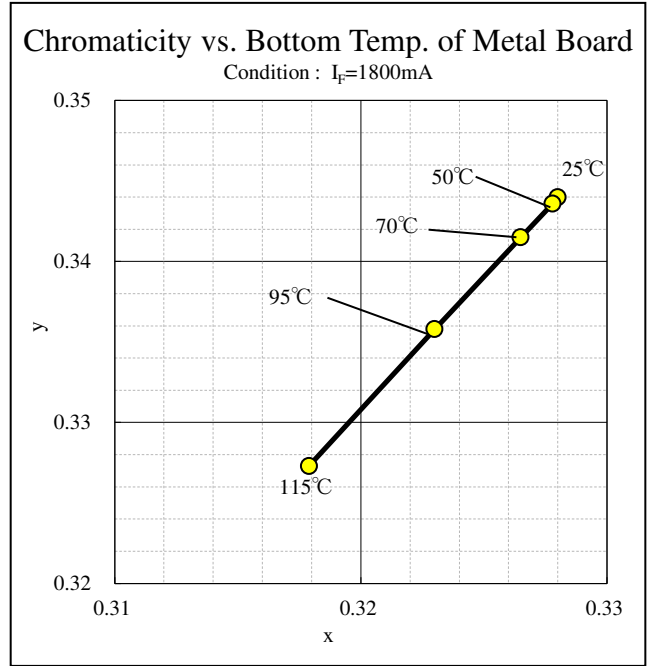
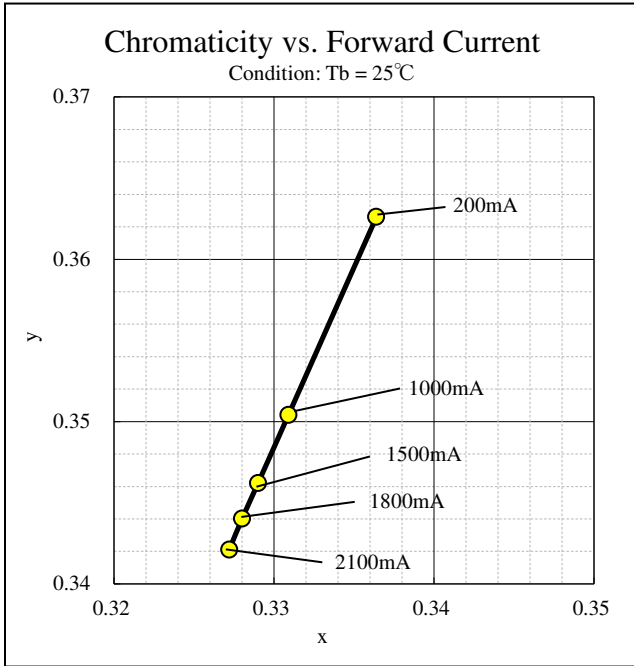

Handling Precaution

【For Electric Static Discharge (ESD)】

This product is sensitive to voltage surges generated by On/Off status change and friction with synthetic materials, which may cause severe damage to the die or undermine its reliability. Damaged products may experience conditions such as extremely high reverse voltage, decrease of forward rise voltage, deterioration in optical characteristics.

Stanley InGaN products are packed with anti-static components. However, following precautions must be taken into account upon product shipment.

1. Electrification/Static Electricity protection

In order to avoid product (die) damage from static electricity caused by unprotected handling by operator and other charged materials coming in contact with the product, Stanley recommends taking the following precautions.

- ① Do not place electrified non-conductive materials near the LED product.
Avoid LED products from coming into contact with metallic materials.(Should the metallic material be electrified , the sudden surge voltage will most likely damage the product.)
- ② Avoid a working process which may cause the LED product to rub against other materials.
- ③ Install ground wires for any equipment, where they can be installed, with measures to avoid static electricity surges.
- ④ Prepare a ESD protective area by placing a Conductive Mattress (1MΩ MAX.) and Ionizer to remove any static electricity.
- ⑤ Operators should wear a protective wrist-strap.
- ⑥ Operators should wear conductive work-clothes and shoes.
- ⑦ To handle the products directly, Stanley recommends the use of ceramic, and not metallic, tweezers.

2. Working Environment

- ① A dry environment is more likely to cause static electricity. Although a dry environment is ideal for storage state of LED products, Stanley recommends an environment with approximately 50% humidity after the soldering process.
- ② Recommended static electricity level in the working environment is less than 150V, which is the same value as Integrated Circuits (which are sensitive to static electricity).

Handling Precaution

【Other Precautions】

1. The products are designed to achieve higher performance reliability, however, they can be influenced by usage conditions.
2. Absolute maximum ratings are set to prevent LED products from breaking due to extreme stress (temperature, current, voltage, etc.). These ratings must never be overrun even for a moment.
3. To achieve the highest performance reliability, it is necessary to take into account, factors such as forward voltage adjusted to the usage temperature condition, derating of the power consumption, and other variable factors.
4. Please insert Straight Protective Resistors into the circuit in order to stabilize LED operation and to prevent the device from overheating.
5. Please do not touch or strike non allowed pick up area (Refer next page), because there is possibility to damage the products. And, please avoid foreign material because molding resin has adhesiveness.
6. Please avoid to use the products with materials and products that contain sulfur and chlorine element because the reliability may be decreased. Please keep in desiccator regardless of before or after mounting not to be affected by corrosive gas when keeping products. Also please make sure if there is any gas which occur in surrounding area or enter from outside when using products.
7. Please check the actual performance in the assembly because the specification sheets are described only for LED device.
8. Please refrain from looking directly at the light source of the LED at high output, as it may harm your vision.
9. The products are designed to perform without failure in the recommended usage conditions. However, please take the necessary precautions to prevent from a fire, injury, and other unexpected failures.
10. The products are manufactured to be used for ordinary electronic equipment. Please contact our sales staff beforehand when exceptional quality and reliability are required, and the failure or malfunction of the products might directly jeopardize life or health (such as for airplanes, aerospace, medical applications, nuclear reactor control systems and so on).
11. The formal specification sheets shall be exchanged and signed by both parties.
12. Please be careful that Supersonic waves may cause open circuit of wire.

Handling Precaution

【Handling Precautions for Product Mounting】

<Recommendation>

Picking up point with nozzle: Metal board portion of the product (Shown below)

The picking up point should be within metal board portion, because the silicone resin used is soft.
(If the nozzle makes contact with the lens, the products might be destroyed)

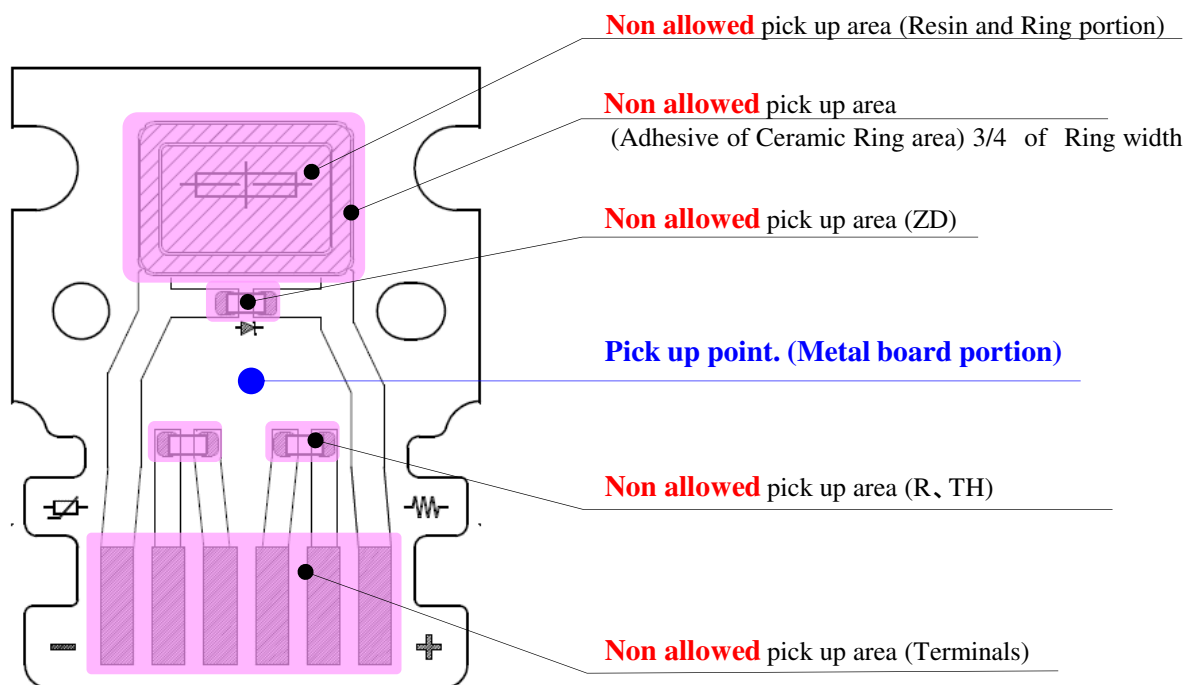

Please adjust the load, the pick up point, the nozzle diameter, etc. before mounting because the over load can cause the breakage of the lamp housing.

This product is baked (moisture removal) before packaging, and is shipped in moisture-proof packaging (as shown below) to minimize moisture absorption during transportation and storage. However, with regard to storing the products, Stanley recommends the use of dry-box under the following conditions is recommended. Moisture-proof bag as the packaging is made of anti-static material but packaging box is not.

【Recommended Storage Condition / Products Warranty Period】

Temperature	+5~30°C
Humidity	Under 70%

In the case of the package unopened , 6 months under 【 Recommended Storage Condition 】.

Please avoid rapid transition from low temp. condition to high temp. condition and storage in corroding and dusty environment.

After unsealing the moisture-proof bag, return the product to a moisture-proof bag, re-seal with a chuck, store it under recommended conditions, and use it promptly.

Packaging Specifications

BUA1052A

【Moisture-proof Packaging Specification】

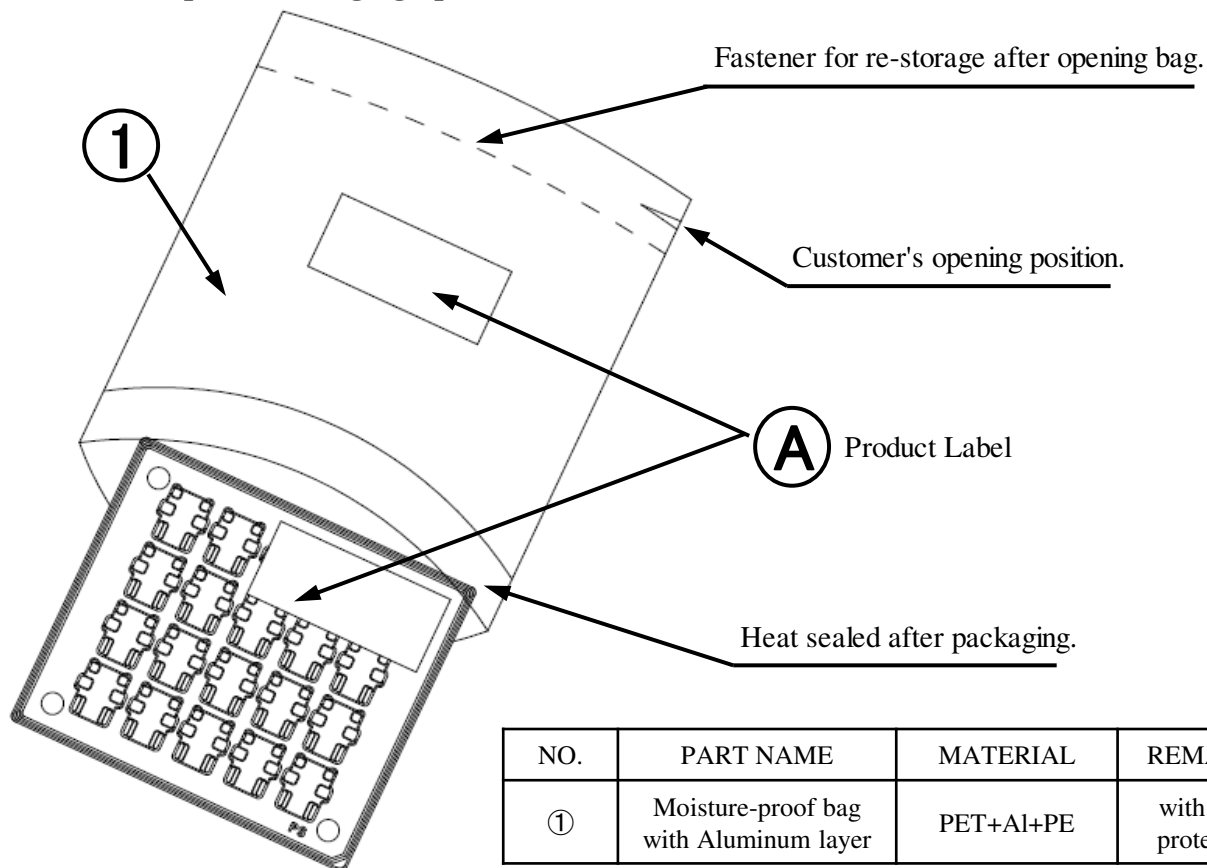

NO.	PART NAME	MATERIAL	REMARKS
①	Moisture-proof bag with Aluminum layer	PET+Al+PE	with ESD protection

【Packaging Box Specifications】

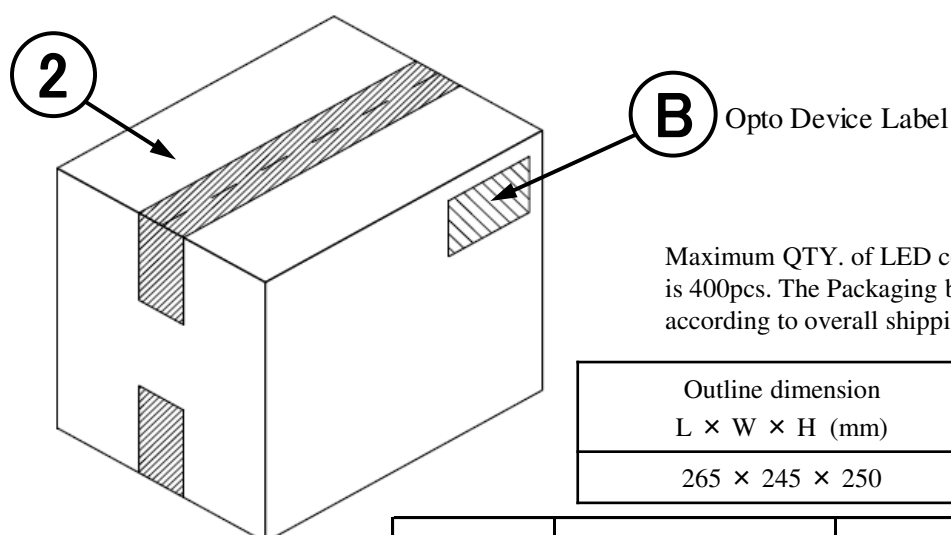

Outline dimension L × W × H (mm)	Capacity of the box
265 × 245 × 250	24 tray

NO.	PART NAME	MATELRIAL	REMARKS
②	Packing Box	Corrugated Cardboard	without ESD protection

Packaging Specifications

BUA1052A

(acc.to JIS-X0503(Code-39))

【Label Specification】

A Product label

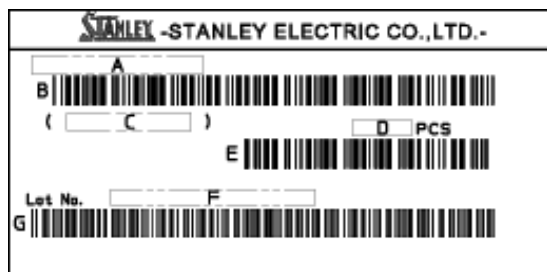

- A. Parts number
 - B. Bar-code for parts number
 - C. Parts code (In-house identification code for each parts number)
 - D. Packed parts quantity
 - E. Bar-Code for packed parts quantity
 - F. Lot number & Rank
- (Please refer to Lot Number Notational System for details)
- G. Bar-Code for Lot number & Rank

B Opto device label

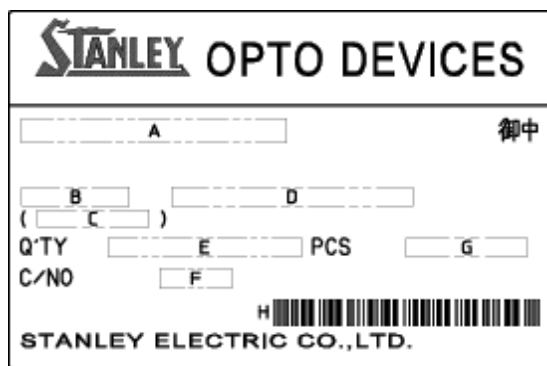

- A. Customer Name
- B. Parts Type
- C. Parts Code
- D. Parts Number
- E. Packed Parts Quantity
- F. Carton Number
- G. Shipping Date
- H. Bar-Code for In-house identification Number

<Remark> Bar-code font : acc.to Code-39 (JIS-X0503)

Tray Specifications

BUA1052A

【Appearance】

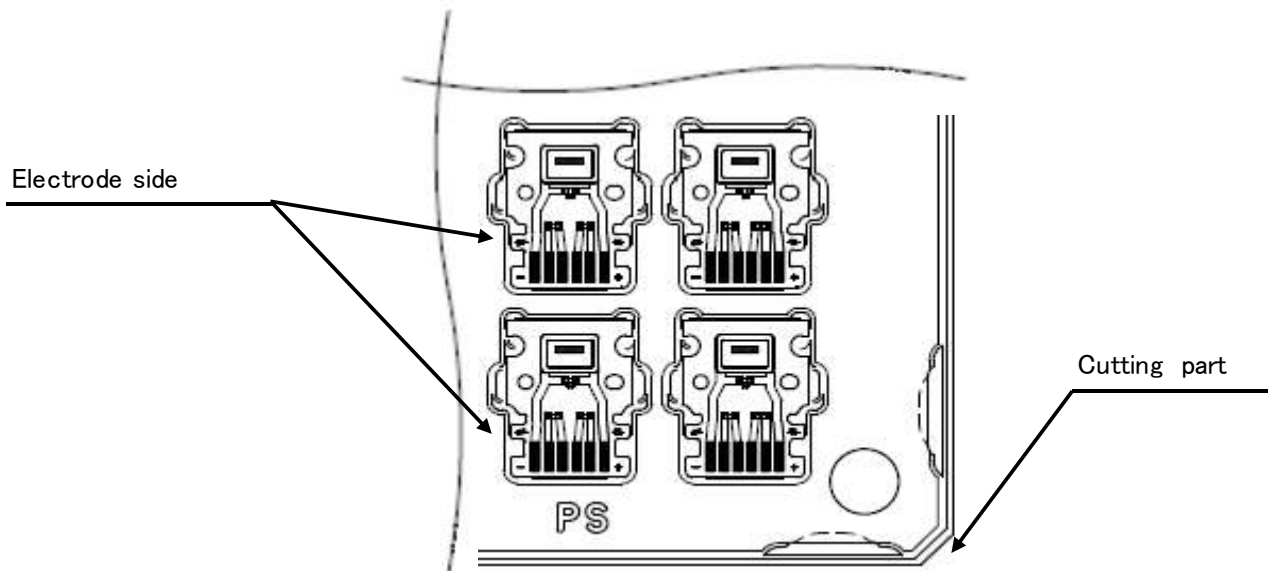
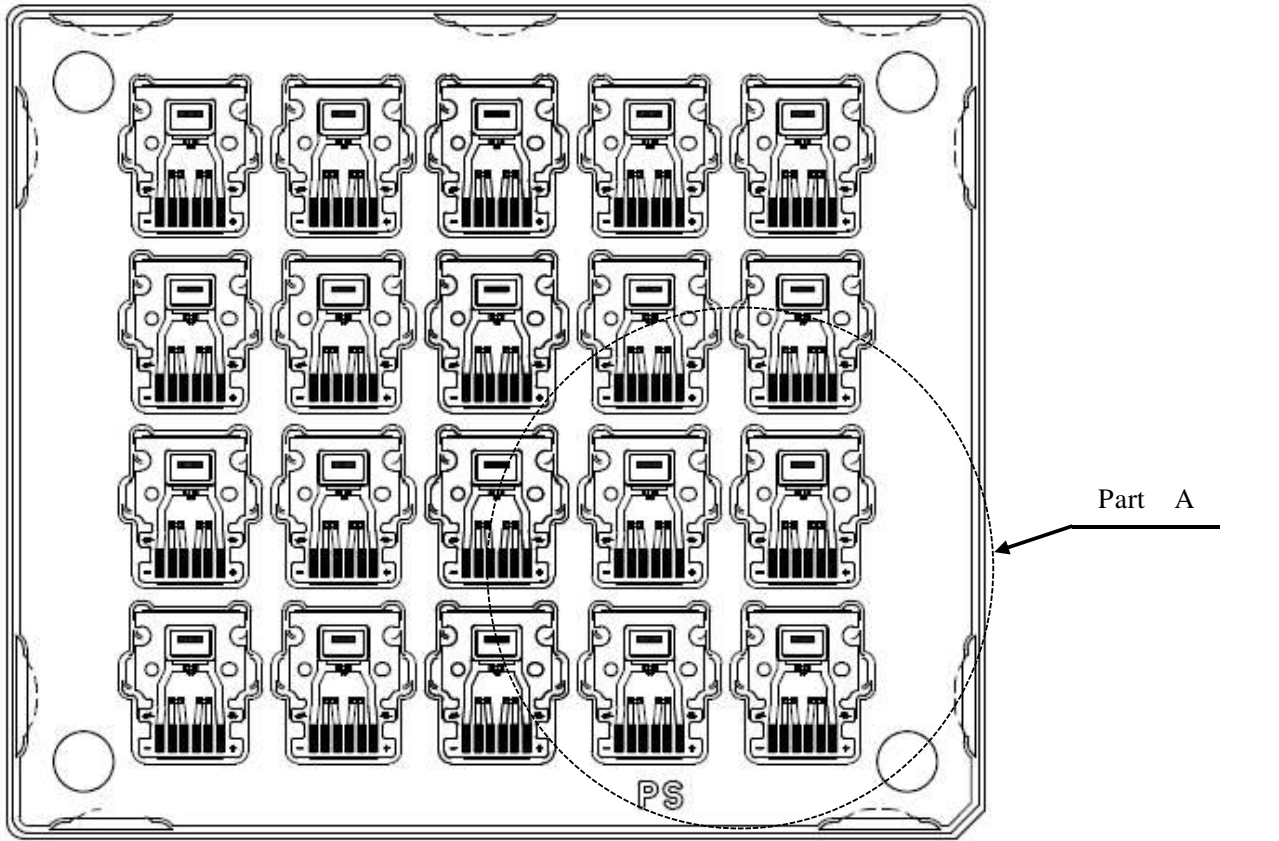

Detail of part A

Taping and Reel Specifications

BUA1052A

【 Packaging Qty.】

20parts / tray

2~6tray / a moisture-proof packaging

MOQ. (Minimum order quantity) is 400pcs

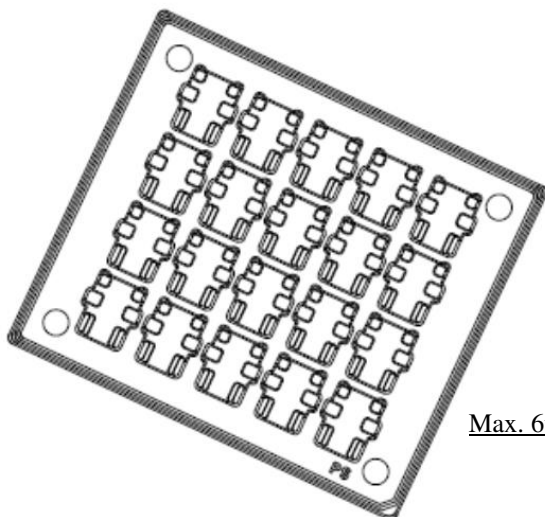

Max. 6tray (The highest tray is an empty tray. :Lid)

【 Others】

Reversed-orientation, Up-side down placing, side placing and out of spec. parts mix shall not be held.

Taping and Reel Specifications

BUA1052A

Unit :mm

【Pocket Dimensions】

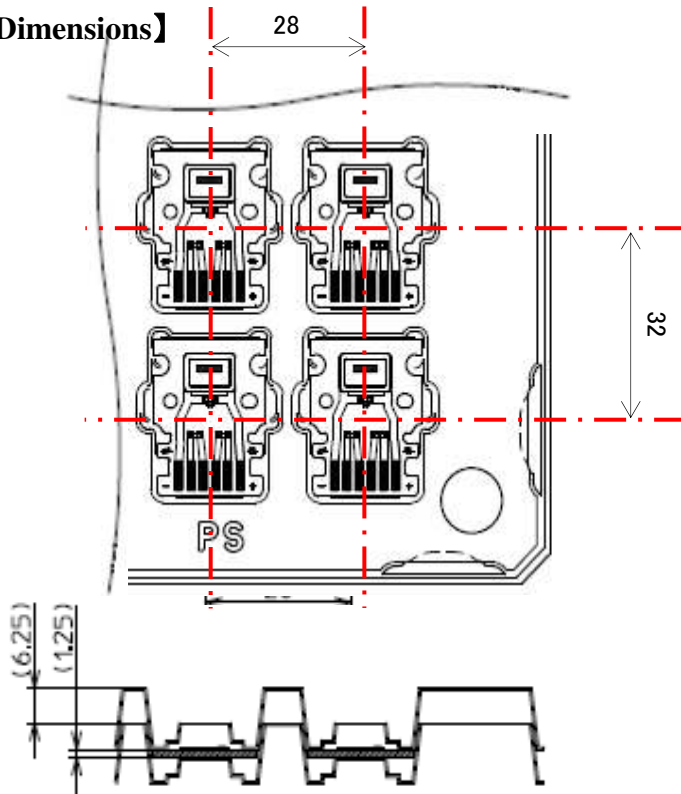

【Tray Dimensions】

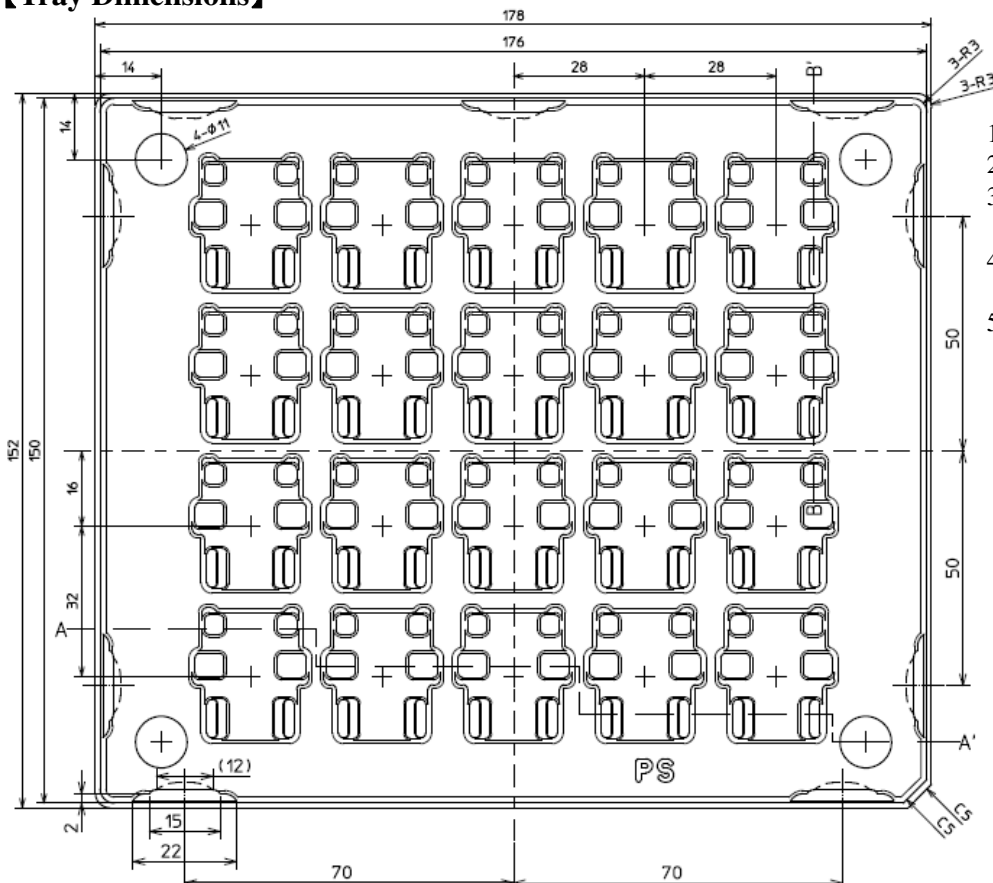

1. Tolerance : $\pm 0.5\text{mm}$
2. Material : PS
3. Surface Resistance : Max. $10E6\Omega$
4. Electrical Voltage : Max. 150V
5. Wrap : $\pm 2.0\text{mm}$

Lot Number Notational System

BUA1052A

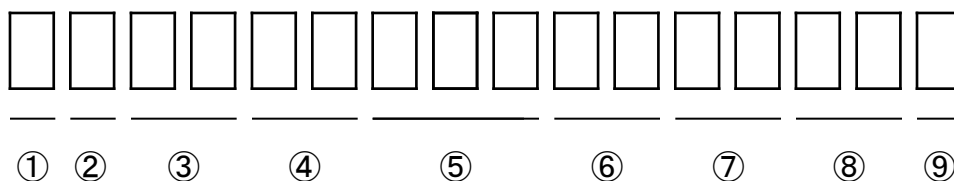

① - 1digit : Production Location (Mark identify alphabet)

② - 1digit : Production Year (Last digit of Production Year 2009→9, 2010→0, 2011→1, …)

③ - 2digits : Production Month (Jan. to Sep. should be 01, 02, 03, ……)

④ - 2digits : Production Date

⑤ - 3digits : Serial Number

⑥ - 2digits : Tray following Number

⑦ - 2digits : Luminous Flux Rank.

(If luminous flux rank is 1 digit, "-" shall be dashed on the place for the second digit.

If there is no identified flux rank, "- -" is used to indicate.)

⑧ - 2digits:Chromaticity Rank

(If chromaticity rank is 1 digit, "-" shall be dashed on the place for the second digit.

If there is no identified intensity rank, "- -" is used to indicate.)

⑨- 1digit: Option Rank (Normally its "-")

Correspondence to RoHS・ELV instruction

BUA1052A

This product is in compliance with RoHS・ELV.

Prohibition substance and it's criteria value of RoHS・ELV are as follows.

- RoHS instruction Refer to following (1)~(6).
- ELV instruction Refer to following (1)~(4).

	Substance Group Name	Criteria Value
(1)	Lead and its compounds	1,000ppm Max
(2)	Cadmium and its compounds	100ppm Max
(3)	Mercury and its compounds	1,000ppm Max
(4)	Hexavalent chromium	1,000ppm Max
(5)	PBB	1,000ppm Max
(6)	PBDE	1,000ppm Max

Reliability Testing Result

BUA1052A

Test Item	Test Condition	Duration	Failuer
High Temp. Operating Life 1	Tj=150°C	4,000h	0 / 8
High Temp. Operating Life 2	Tj=160°C	1,000h	0 / 8
High Temp. Operating Life 3	Tj=175°C	100h	0 / 8
High Temp. Strage Life	Ta=120°C	1,000h	0 / 8
Low Temp. Strage Life	Ta=-40°C	1,000h	0 / 8
Low Temp. Operating	Ta=-40°C I _F =1,800mA	1,000h	0 / 8
High Temp. Humidity Bias	Ta=85°C Rh=85% Tj=150°C	2,000h	0 / 8
High Temp. On/Off Operating	Ta=85°C Tj=150°C 1cycle:15min/ON⇔15min/OFF	1,000 cycles	0 / 8
Low Temp. On/Off Operating	Ta=-40°C I _F =1,800mA 1cycle:15min/ON⇔15min/OFF	1,000 cycles	0 / 8
Thermal Shock Cycle (Operating)	Ta=-40°C (15min./OFF) ~ 85°C/Tj=150°C (15min./ON) ※1 : Refer to Figure 1	1,000 cycles	0 / 8
Thermal Shock Cycle (Non-Operating)	Ta=-40°C (15min.) ~ 85°C (15min.) = 1cycle ※2 : Refer to Figure 2	1,000 cycles	0 / 8
Electrostatic Discharge (ESD) : HBM	C=100pF R2=1.5kΩ ±8,000V (Each polarity)	3times of each	0 / 4
Electrostatic Discharge (ESD) : MM	C=200pF R2=0Ω ±250V (Each polarity)	3times of each	0 / 4
Thermal & High Humidity Cycle	Ta=-30°C~80°C Rh=90% 8h/cyc I _F =700mA 5min/ON⇔5min/OFF ※3 : Refer to Figure 3	30 cycles	0 / 4
Hydrogen Sulfide Test	H ₂ S : 3ppm NO ₂ : 6ppm Ta=40°C (RH80%)	135h	0 / 4
Vibration Test	196m/s ² (20G) 50~500H XYZ-direction	20h of each direction	0 / 4
Mechanical Shock Test	14,700m/s ² (1,500G) 0.5ms 6direction	3times of each direction	0 / 4

Reliability Testing Result

BUA1052A

Item	Symbol	Conditions	Acceptance Criteria
Luminous Intensity	I_V	$I_F=1,800\text{mA}$ $T_a=25^\circ\text{C}$	Initial Value $\times 0.8 >$ Measured Value Initial Value $\times 1.2 \leq$ Measured Value
Chromaticity Coordinates	ccx, ccy	$I_F=1,800\text{mA}$ $T_a=25^\circ\text{C}$	Measured Value $<$ Initial Value - 0.02 Measured Value $>$ Initial Value + 0.02
Forward Voltage	V_F	$I_F=1,800\text{mA}$ $T_a=25^\circ\text{C}$	Measured Value $<$ Initial Value $\times 0.9$ Measured Value $>$ Initial Value $\times 1.1$
Appearance	—	—	Notable discoloration, deformation and crack

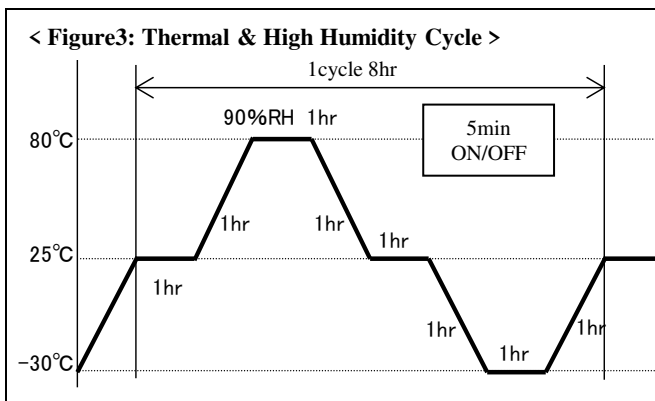
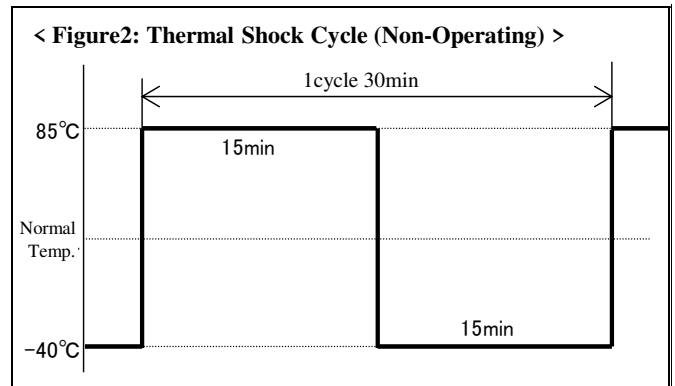
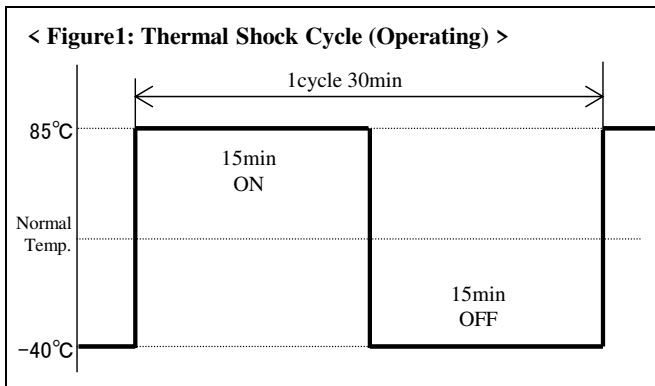

Special Notice to Customers Using the Products and Technical Information Shown in This Data Sheet

- 1) The technical information shown in the data sheets are limited to the typical characteristics and circuit examples of the referenced products. It does not constitute the warranting of industrial property nor the granting of any license.
- 2) For the purpose of product improvement, the specifications, characteristics and technical data described in the data sheets are subject to change without prior notice. Therefore it is recommended that the most updated specifications be used in your design.
- 3) When using the products described in the data sheets, please adhere to the maximum ratings for operating voltage, heat dissipation characteristics, and other precautions for use. We are not responsible for any damage which may occur if these specifications are exceeded.
- 4) The products that have been described to this catalog are manufactured so that they will be used for the electrical instrument of the benchmark (OA equipment, telecommunications equipment, AV machine, home appliance and measuring instrument).
The application of aircrafts, space borne application, transportation equipment, medical equipment and nuclear power control equipment, etc. needs a high reliability and safety, and the breakdown and the wrong operation might influence the life or the human body. Please consult us beforehand if you plan to use our product for the usages of aircrafts, space borne application, transportation equipment, medical equipment and nuclear power control equipment, etc. except OA equipment, telecommunications equipment, AV machine, home appliance and measuring instrument.
- 5) In order to export the products or technologies described in this data sheet which are under the “Foreign Exchange and Foreign Trade Control Law,” it is necessary to first obtain an export permit from the Japanese government.
- 6) No part of this data sheet may be reprinted or reproduced without prior written permission from Stanley Electric Co., Ltd.
- 7) The most updated edition of this data sheet can be obtained from the address below:
<http://www.stanley-components.com/en/>