

Digital Attenuator, 6-Bit, Serial / Parallel Control

0.1 - 30 GHz, 31.5 Attenuation Range



MAAD-011036

Rev. V1

Features

- 6-Bit, 0.5 dB LSB, 31.5 dB Range
- Integrated CMOS Driver
- Parallel or Serial (P/S) Control
- Low DC Power Consumption
- Attenuation Accuracy:
+/- (0.4 + 7% of attenuation setting) dB
- Lead-Free 4 mm 24-Lead PQFN Package
- RoHS* Compliant

Applications

- Test Equipment (instrumentation)
- Communications (commercial and military) :
Cellular Infrastructure
Radars
Radios (MMW)
- General Purpose

Description

The MAAD-011036 is a wide band 6-bit, 0.5 dB step MMIC digital attenuator in a lead-free 4 mm 24 lead PQFN surface mount plastic package. This device is ideally suited for use where high accuracy, very low power consumption, and low intermodulation products are required.

This attenuator is controlled with either a SPI compatible serial interface or a 6 bit parallel word.

Functional Schematic

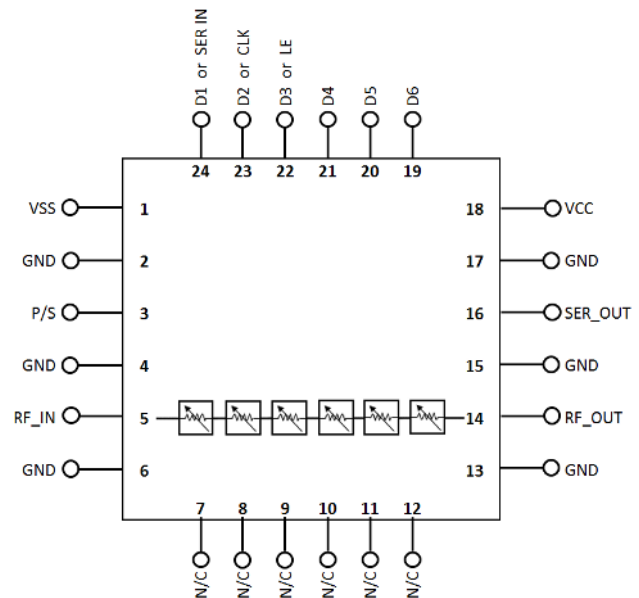

Pin Configuration^{1,2}

Pin #	Function
1	VSS
2, 4, 6, 13, 15, 17	GND
3	P/S
7 - 12	N/C
5	RF IN
14	RF OUT
16	SER OUT
18	VCC
19	D6
20	D5
21	D4
22	D3 or LE
23	D2 or CLK
24	D1 or SER IN

1. MACOM recommends grounding all N/C (no connection) pins
2. The exposed pad centered on the package bottom must be connected to RF, DC and thermal ground.

Ordering Information

Part Number	Package
MAAD-011036-TR0500	500 piece reel
MAAD-011036-001SMB	Sample Board

* Restrictions on Hazardous Substances, compliant to current RoHS EU directive.

Digital Attenuator, 6-Bit, Serial / Parallel Control

0.1 - 30 GHz, 31.5 Attenuation Range



MAAD-011036

Rev. V1

Electrical Specifications:

Freq. = 0.1 - 30 GHz, $T_A = 25^\circ\text{C}$, $Z_0 = 50 \Omega$, $V_{CC} = +5 \text{ V}$, $V_{SS} = -5 \text{ V}$, $P_{IN} = 0 \text{ dBm}$

Parameter	Test Conditions	Units	Min.	Typ.	Max.
Reference Insertion Loss ³	0.1 - 18.0 GHz 18.0 - 26.5 GHz 26.5 - 30.0 GHz	dB	—	3.6 4.8 5.5	4.8 — 6.7
RMS Attenuation Error ⁴	0.1 - 30.0 GHz (RMS, mean)	dB	—	0.5	—
Attenuation Accuracy	Relative to Insertion Loss (0.1 - 30 GHz)	± (0.4 + 7% of attenuation setting), typ.			
Return Loss (IN & OUT)	All states	dB	—	-12	—
Input P0.1dB	Reference State (beyond 1 GHz)	dBm	—	23	—
IIP ₃	2-Tone, +10 dBm/tone, 1 MHz Spacing Reference State (beyond 1 GHz)	dBm	—	41	—
T _{RISE} , T _{FALL}	10% to 90% RF, 90% to 10% RF	ns	—	15	—
V _{CC}	—	V	+3.0	-	+5.5
I _{CC}	—	μA	—	5	—
V _{SS}	—	V	-5.5	-5.0	-3.0
I _{SS}	—	mA	—	-0.1	—
V _H V _L	HIGH level control voltage LOW level control voltage	V	0.7 X V _{CC} 0.0	—	V _{CC} 0.3 X V _{CC}
ESD	HBM	V	—	Class 1A	—

3. Test frequencies = 1 GHz, 18 GHz, and 30 GHz.

4. RMS calculation, mean:

$$RMS \text{ ERROR, mean} = \sqrt{\frac{1}{n} \sum (Er_i - Er_{Ave})^2}$$

Truth Table⁵

D6	D5	D4	D3	D2	D1	Attenuation (dB)
0	0	0	0	0	0	Reference IL
0	0	0	0	0	1	0.5
0	0	0	0	1	0	1
0	0	0	1	0	0	2
0	0	1	0	0	0	4
0	1	0	0	0	0	8
1	0	0	0	0	0	16
1	1	1	1	1	1	31.5

5. "0" = CMOS Low, "1" = COMS High (see specifications table).

Absolute Maximum Ratings^{6,7}

Parameter	Absolute Maximum
Input Power	31 dBm
V _{CC} Voltage	6 V
Control Voltage	-0.5 V ≤ V _C ≤ 5.5 V
Junction Temperature	+150°C
Operating Temperature	-40°C to +85°C
Storage Temperature	-65°C to +150°C

6. Exceeding any one or combination of these limits may cause permanent damage to this device.
7. MACOM does not recommend sustained operation near these survivability limits.

2

MACOM Technology Solutions Inc. (MACOM) and its affiliates reserve the right to make changes to the product(s) or information contained herein without notice. Visit www.macom.com for additional data sheets and product information.

For further information and support please visit:
<https://www.macom.com/support>

DC-0012542

Digital Attenuator, 6-Bit, Serial / Parallel Control

0.1 - 30 GHz, 31.5 Attenuation Range



MAAD-011036

Rev. V1

Typical RF Performance Plots, @ +25°C

Relative Attenuation

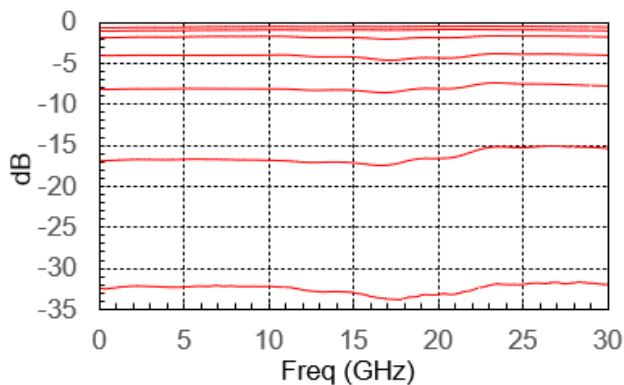

Insertion Loss vs. Temperature

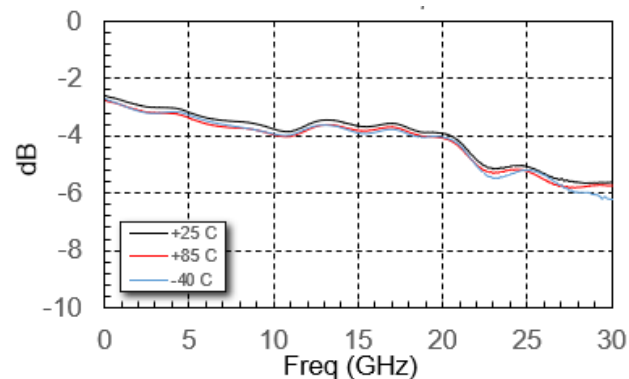

Input Return Loss (all states)

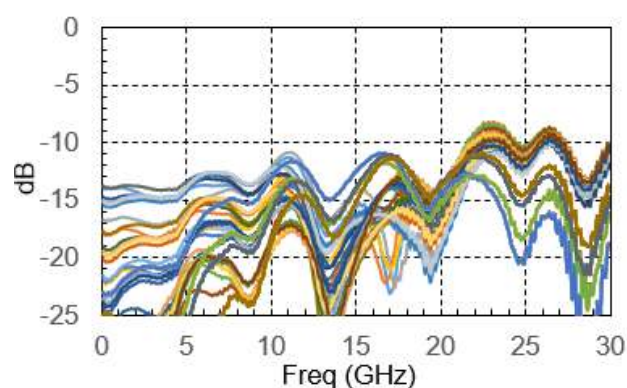

Input Return Loss vs. Temperature

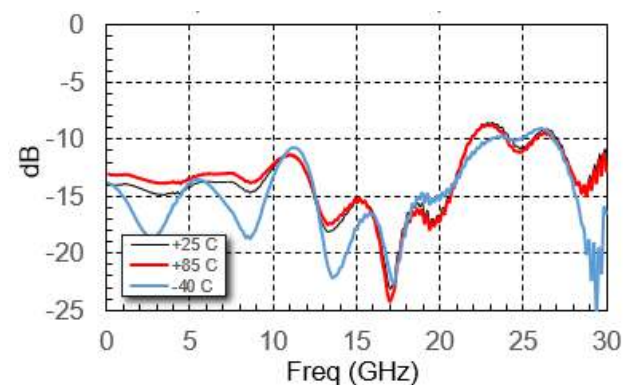

Output Return Loss (all states)

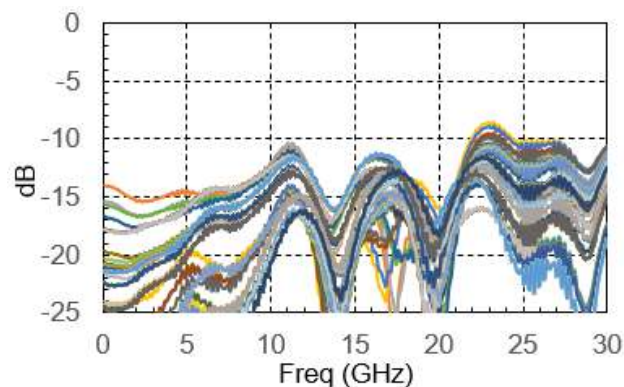

Output Return Loss vs. Temperature

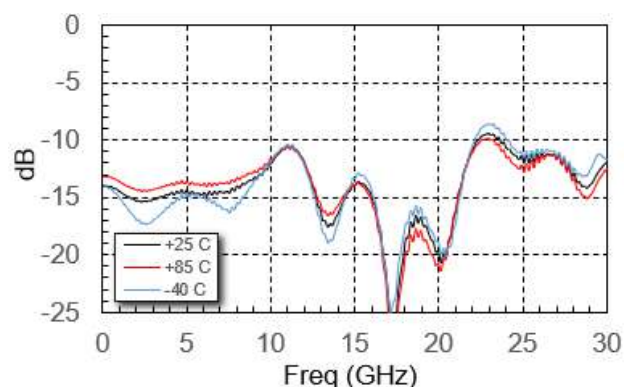

Digital Attenuator, 6-Bit, Serial / Parallel Control

0.1 - 30 GHz, 31.5 Attenuation Range



MAAD-011036

Rev. V1

BIT Error vs. Attenuation State
0.1 - 18 GHz, @ +25°C

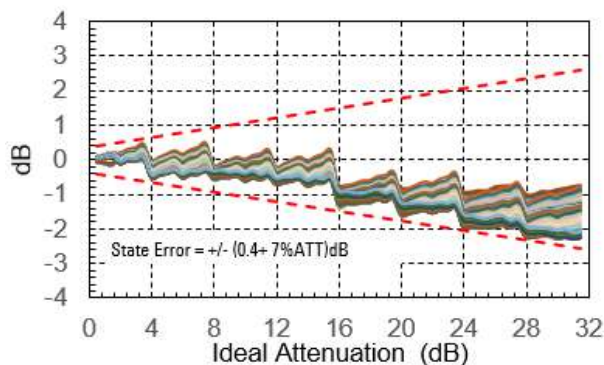

RMS Error vs. Frequency (mean)

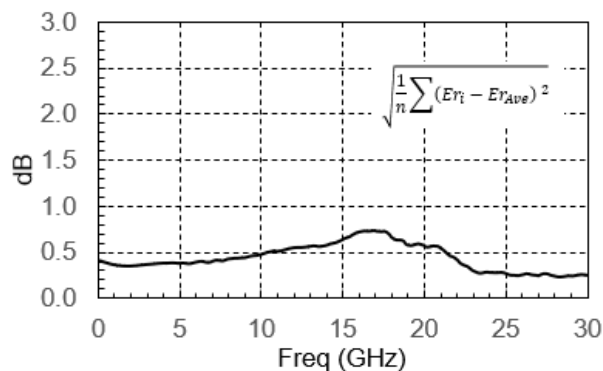

BIT Error vs. Attenuation State
18 - 26.5 GHz, @ +25°C

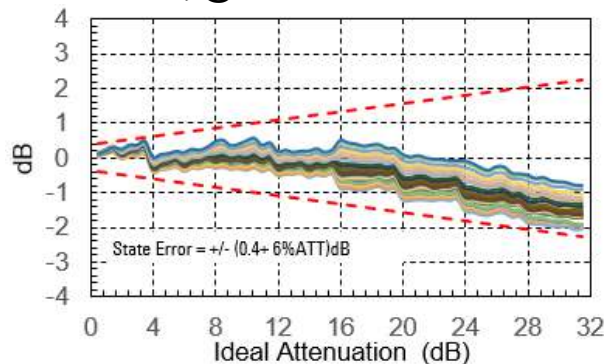

Input 0.1dB Compression over Temp

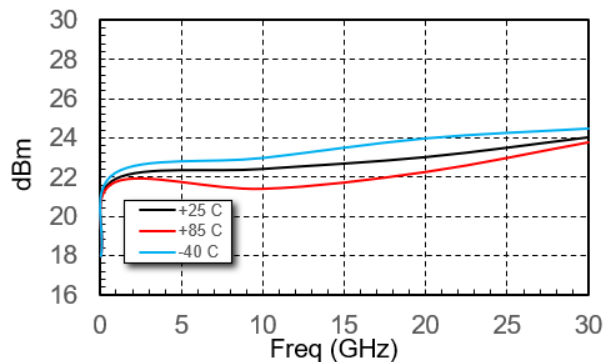

BIT Error vs. Attenuation State
26.5 - 30GHz, @ +25°C

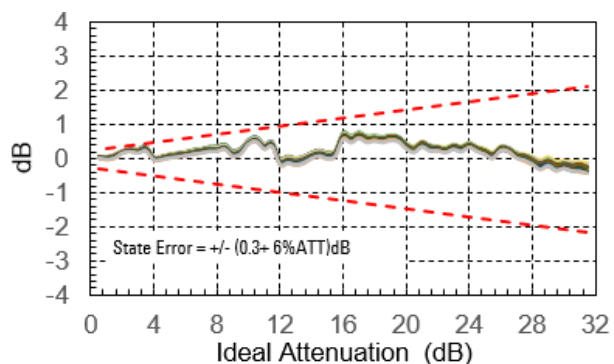

Input IP3 over Temperature

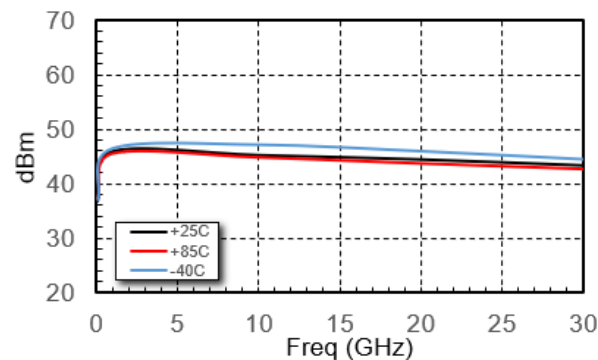

Modes of Operation Serial and Direct Parallel

Mode Truth Table⁸

P/S	LE	Mode
1	X	Serial
0	N/A	Direct Parallel

8. In the serial mode: D4, D5, and D6 should be tied to ground or to V_{CC} .

Direct Parallel Mode

The parallel mode is enabled when P/S is set low. In the direct parallel mode, the digital attenuator is controlled by the parallel control inputs directly. When P/S is set low, pins 22, 23, and 24 have the D3, D2, and D1 function.

Handling Procedures

Please observe the following precautions to avoid damage:

Static Sensitivity

These electronic devices are sensitive to electrostatic discharge (ESD) and can be damaged by static electricity. Proper ESD control techniques should be used when handling these HBM Class 1A devices.

Serial Mode

The serial control interface (SERI IN, CLK, LE, SER OUT) is compatible with the SPI protocol. SPI mode is activated when P/S is kept high. The 6-bit serial word must be loaded with the MSB first. After shifting in the 6 bit word, a rising edge on LE will set the digital attenuator to the desired state. While LE is high the CLK is masked to protect the data while implementing the change. SER OUT is SER IN delayed by 6 clock cycles.

When P/S is low, the serial control interface is disabled. When P/S is set high, pins 22, 23, and 24 have the LE, CLK, and SER IN function.

In serial mode operation, the outputs will stay constant while LE is kept low.

Functionality
Modes of Operation: Serial and Direct Parallel

Serial Input Interface Timing Diagram

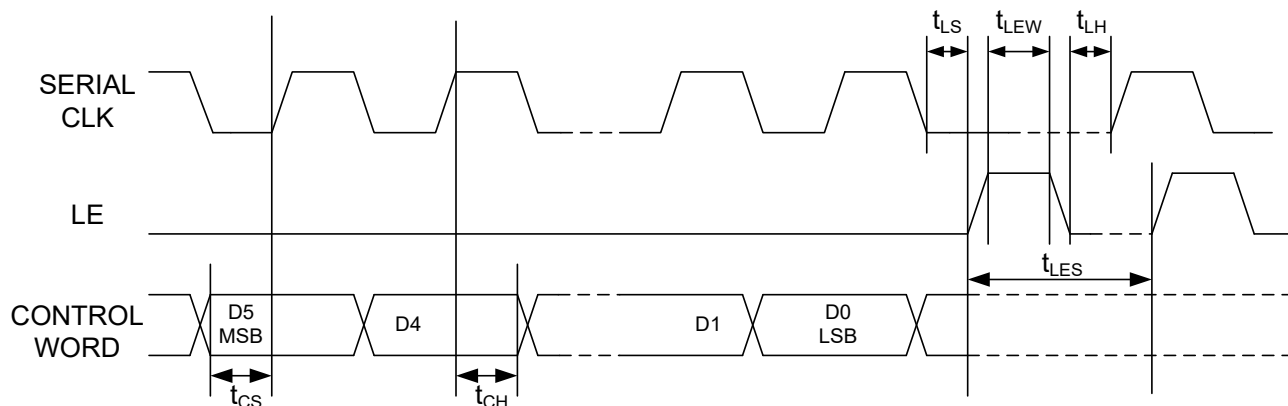

Serial Interface Timing Characteristics

Symbol	Parameter	Units
t_{SCK}	Min. Serial Clock Period	ns
t_{CS}	Min. Control Set-up Time	ns
t_{CH}	Min. Control Hold Time	ns
t_{LS}	Min. LE Set-up Time	ns
t_{LEW}	Min. LE Pulse Width	ns
t_{LH}	Min. Serial Clock Hold Time from LE	ns
t_{LES}	Min. LE Pulse Spacing	ns

Digital Attenuator, 6-Bit, Serial / Parallel Control

0.1 - 30 GHz, 31.5 Attenuation Range



MAAD-011036

Rev. V1

Lead Free 4 mm 24-Lead PQFN †

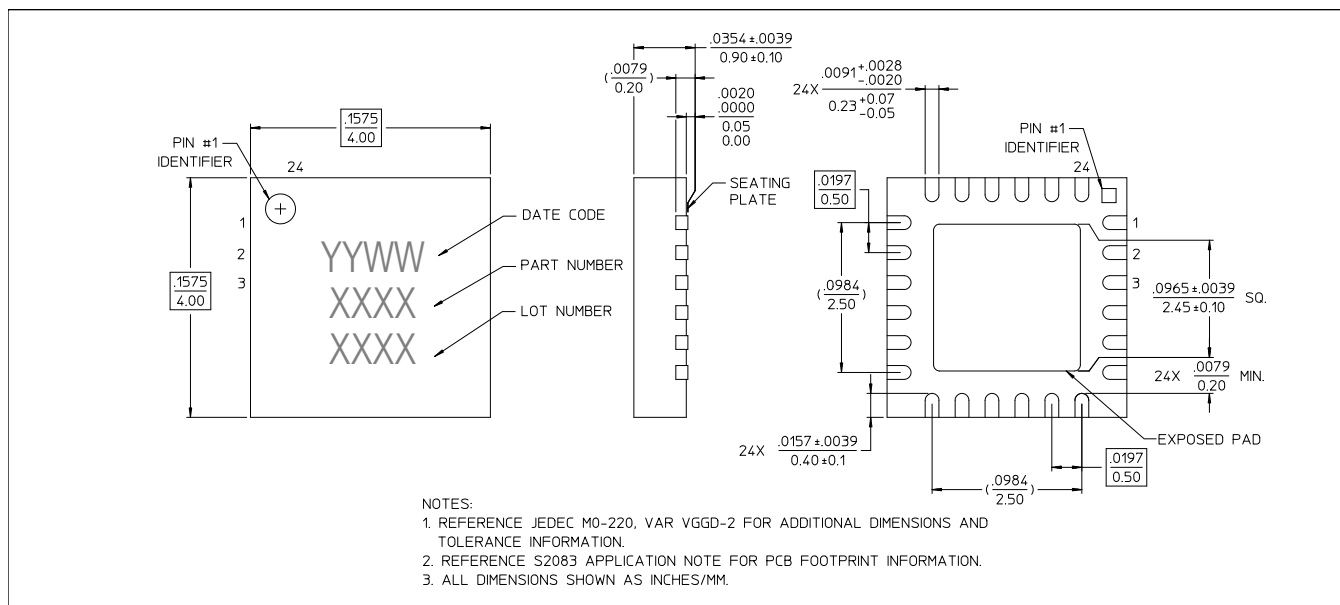

† Reference Application Note S2083 for lead-free solder reflow recommendations.
 Meets JEDEC moisture sensitivity level 1 requirements.
 Plating is 100% matte tin over copper.

Digital Attenuator, 6-Bit, Serial / Parallel Control

0.1 - 30 GHz, 31.5 Attenuation Range



MAAD-011036

Rev. V1

MACOM Technology Solutions Inc. ("MACOM"). All rights reserved.

These materials are provided in connection with MACOM's products as a service to its customers and may be used for informational purposes only. Except as provided in its Terms and Conditions of Sale or any separate agreement, MACOM assumes no liability or responsibility whatsoever, including for (i) errors or omissions in these materials; (ii) failure to update these materials; or (iii) conflicts or incompatibilities arising from future changes to specifications and product descriptions, which MACOM may make at any time, without notice. These materials grant no license, express or implied, to any intellectual property rights.

THESE MATERIALS ARE PROVIDED "AS IS" WITH NO WARRANTY OR LIABILITY, EXPRESS OR IMPLIED, RELATING TO SALE AND/OR USE OF MACOM PRODUCTS INCLUDING FITNESS FOR A PARTICULAR PURPOSE, MERCHANTABILITY, INFRINGEMENT OF INTELLECTUAL PROPERTY RIGHT, ACCURACY OR COMPLETENESS, OR SPECIAL, INDIRECT, INCIDENTAL, OR CONSEQUENTIAL DAMAGES WHICH MAY RESULT FROM USE OF THESE MATERIALS.

MACOM products are not intended for use in medical, lifesaving or life sustaining applications. MACOM customers using or selling MACOM products for use in such applications do so at their own risk and agree to fully indemnify MACOM for any damages resulting from such improper use or sale.