

Preliminary datasheet

62 mm C-Series module with Trench/Fieldstop IGBT4 and Emitter Controlled 4 diode

Features

- Electrical features
 - $V_{CES} = 1200\text{ V}$
 - $I_{C\text{nom}} = 600\text{ A} / I_{CRM} = 1200\text{ A}$
 - Unbeatable robustness
 - Extended operating temperature $T_{vj\text{op}}$
 - Low switching losses
 - Low V_{CESat}
 - V_{CESat} with positive temperature coefficient
- Mechanical features
 - 4 kV AC 1 min insulation
 - Package with CTI > 400
 - High creepage and clearance distances
 - High power density
 - Isolated base plate
 - Standard housing



Potential applications

- High power converters
- Motor drives
- UPS systems
- Wind turbines

Product validation

- Qualified for industrial applications according to the relevant tests of IEC 60747, 60749 and 60068

Description

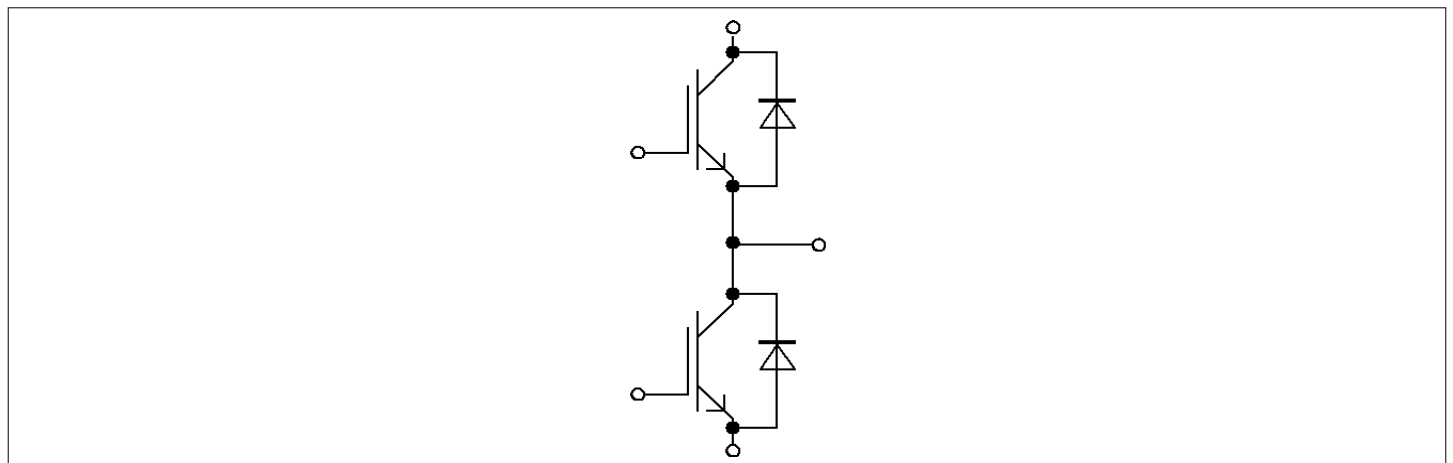

Table of contents

	Description	1
	Features	1
	Potential applications	1
	Product validation	1
	Table of contents	2
1	Package	3
2	IGBT, Inverter	3
3	Diode, Inverter	5
4	Characteristics diagrams	6
5	Circuit diagram	10
6	Package outlines	11
7	Module label code	12
	Disclaimer	13

1 Package

Table 1 Insulation coordination

Parameter	Symbol	Note or test condition	Values	Unit
Material of module baseplate			Cu	
Internal Isolation		basic insulation (class 1, IEC 61140)	Al2O3	
Comparative tracking index	CTI		> 400	
RTI Elec.	RTI	housing	140	°C

Table 2 Characteristic values

Parameter	Symbol	Note or test condition	Values			Unit
			Min.	Typ.	Max.	
Stray inductance module	L_{sCE}			20		nH
Storage temperature	T_{stg}		-40		125	°C
Mounting torque for modul mounting	M	- Mounting according to M6, Screw valid application note	3		6	Nm
Terminal connection torque	M	- Mounting according to M6, Screw valid application note	2.5		5	Nm

2 IGBT, Inverter

Table 3 Maximum rated values

Parameter	Symbol	Note or test condition	Values	Unit
Collector-emitter voltage	V_{CES}	$T_{vj} = 25\text{ °C}$	1200	V
Continous DC collector current	I_{CDC}	$T_{vj\ max} = 175\text{ °C}$ $T_C = 100\text{ °C}$	600	A
Repetitive peak collector current	I_{CRM}	$t_P = 1\text{ ms}$	1200	A
Gate-emitter peak voltage	V_{GES}		±20	V

Table 4 Characteristic values

Parameter	Symbol	Note or test condition	Values			Unit
			Min.	Typ.	Max.	
Collector-emitter saturation voltage	$V_{CE\ sat}$	$I_C = 600\text{ A}, V_{GE} = 15\text{ V}$ $T_{vj} = 25\text{ °C}$ $T_{vj} = 125\text{ °C}$ $T_{vj} = 150\text{ °C}$		1.75	2.20	V
				2.00		
				2.05		
Gate threshold voltage	V_{GEth}	$I_C = 22.8\text{ mA}, V_{CE} = V_{GE}, T_{vj} = 25\text{ °C}$	5.25	5.80	6.35	V
Gate charge	Q_G	$V_{GE} = \pm 15\text{ V}, V_{CE} = 600\text{ V}$		5		μC
Internal gate resistor	R_{Gint}	$T_{vj} = 25\text{ °C}$		1.3		Ω

Table 4 Characteristic values (continued)

Parameter	Symbol	Note or test condition	Values			Unit
			Min.	Typ.	Max.	
Input capacitance	C_{ies}	$f = 1000 \text{ kHz}, T_{vj} = 25 \text{ }^\circ\text{C}, V_{CE} = 25 \text{ V}, V_{GE} = 0 \text{ V}$		38		nF
Reverse transfer capacitance	C_{res}	$f = 1000 \text{ kHz}, T_{vj} = 25 \text{ }^\circ\text{C}, V_{CE} = 25 \text{ V}, V_{GE} = 0 \text{ V}$		1.4		nF
Collector-emitter cut-off current	I_{CES}	$V_{CE} = 1200 \text{ V}, V_{GE} = 0 \text{ V} \quad T_{vj} = 25 \text{ }^\circ\text{C}$			5	mA
Gate-emitter leakage current	I_{GES}	$V_{CE} = 0 \text{ V}, V_{GE} = 20 \text{ V}, T_{vj} = 25 \text{ }^\circ\text{C}$			400	nA
Turn-on delay time (inductive load)	t_{don}	$I_C = 600 \text{ A}, V_{CE} = 600 \text{ V}, V_{GE} = \pm 15 \text{ V}, R_{Gon} = 0.62 \text{ } \Omega$		$T_{vj} = 25 \text{ }^\circ\text{C}$	0.170	μs
				$T_{vj} = 125 \text{ }^\circ\text{C}$	0.180	
				$T_{vj} = 150 \text{ }^\circ\text{C}$	0.180	
Rise time (inductive load)	t_r	$I_C = 600 \text{ A}, V_{CE} = 600 \text{ V}, V_{GE} = \pm 15 \text{ V}, R_{Gon} = 0.62 \text{ } \Omega$		$T_{vj} = 25 \text{ }^\circ\text{C}$	0.046	μs
				$T_{vj} = 125 \text{ }^\circ\text{C}$	0.048	
				$T_{vj} = 150 \text{ }^\circ\text{C}$	0.052	
Turn-off delay time (inductive load)	t_{doff}	$I_C = 600 \text{ A}, V_{CE} = 600 \text{ V}, V_{GE} = \pm 15 \text{ V}, R_{Goff} = 0.62 \text{ } \Omega$		$T_{vj} = 25 \text{ }^\circ\text{C}$	0.400	μs
				$T_{vj} = 125 \text{ }^\circ\text{C}$	0.500	
				$T_{vj} = 150 \text{ }^\circ\text{C}$	0.530	
Fall time (inductive load)	t_f	$I_C = 600 \text{ A}, V_{CE} = 600 \text{ V}, V_{GE} = \pm 15 \text{ V}, R_{Goff} = 0.62 \text{ } \Omega$		$T_{vj} = 25 \text{ }^\circ\text{C}$	0.070	μs
				$T_{vj} = 125 \text{ }^\circ\text{C}$	0.160	
				$T_{vj} = 150 \text{ }^\circ\text{C}$	0.190	
Turn-on energy loss per pulse	E_{on}	$I_C = 600 \text{ A}, V_{CE} = 600 \text{ V}, L_\sigma = 35 \text{ nH}, V_{GE} = \pm 15 \text{ V}, R_{Gon} = 0.62 \text{ } \Omega, di/dt = 11000 \text{ A}/\mu\text{s} (T_{vj} = 150 \text{ }^\circ\text{C})$		$T_{vj} = 25 \text{ }^\circ\text{C}$	16	mJ
				$T_{vj} = 125 \text{ }^\circ\text{C}$	29.5	
				$T_{vj} = 150 \text{ }^\circ\text{C}$	35.5	
Turn-off energy loss per pulse	E_{off}	$I_C = 600 \text{ A}, V_{CE} = 600 \text{ V}, L_\sigma = 35 \text{ nH}, V_{GE} = \pm 15 \text{ V}, R_{Goff} = 0.62 \text{ } \Omega, dv/dt = 3600 \text{ V}/\mu\text{s} (T_{vj} = 150 \text{ }^\circ\text{C})$		$T_{vj} = 25 \text{ }^\circ\text{C}$	50	mJ
				$T_{vj} = 125 \text{ }^\circ\text{C}$	74	
				$T_{vj} = 150 \text{ }^\circ\text{C}$	82	
SC data	I_{SC}	$V_{GE} \leq 15 \text{ V}, V_{CC} = 800 \text{ V}, V_{CEmax} = V_{CES} - L_{sCE} * di/dt$	$t_p \leq 10 \text{ } \mu\text{s}, T_{vj} = 150 \text{ }^\circ\text{C}$		2600	A
Thermal resistance, junction to case	R_{thJC}	per IGBT			0.0460	K/W
Thermal resistance, case to heatsink	R_{thCH}	per IGBT, $\lambda_{grease} = 1 \text{ W}/(\text{m}^*\text{K})$			0.0226	K/W
Temperature under switching conditions	T_{vjop}			-40	150	$^\circ\text{C}$

3 Diode, Inverter

Table 5 Maximum rated values

Parameter	Symbol	Note or test condition	Values	Unit	
Repetitive peak reverse voltage	V_{RRM}	$T_{vj} = 25\text{ °C}$	1200	V	
Continuous DC forward current	I_F		600	A	
Repetitive peak forward current	I_{FRM}	$t_P = 1\text{ ms}$	1200	A	
I^2t - value	I^2t	$t_P = 10\text{ ms}, V_R = 0\text{ V}$	$T_{vj} = 125\text{ °C}$	35000	A^2s
			$T_{vj} = 150\text{ °C}$	33000	

Table 6 Characteristic values

Parameter	Symbol	Note or test condition	Values			Unit	
			Min.	Typ.	Max.		
Forward voltage	V_F	$I_F = 600\text{ A}, V_{GE} = 0\text{ V}$		$T_{vj} = 25\text{ °C}$	1.85	2.45	V
				$T_{vj} = 125\text{ °C}$	1.80		
				$T_{vj} = 150\text{ °C}$	1.75		
Peak reverse recovery current	I_{RM}	$V_R = 600\text{ V}, I_F = 600\text{ A}, V_{GE} = -15\text{ V}, -di_F/dt = 11000\text{ A}/\mu\text{s} (T_{vj} = 150\text{ °C})$		$T_{vj} = 25\text{ °C}$	535	A	
				$T_{vj} = 125\text{ °C}$	655		
				$T_{vj} = 150\text{ °C}$	680		
Recovered charge	Q_r	$V_R = 600\text{ V}, I_F = 600\text{ A}, V_{GE} = -15\text{ V}, -di_F/dt = 11000\text{ A}/\mu\text{s} (T_{vj} = 150\text{ °C})$		$T_{vj} = 25\text{ °C}$	50.5	μC	
				$T_{vj} = 125\text{ °C}$	94		
				$T_{vj} = 150\text{ °C}$	110		
Reverse recovery energy	E_{rec}	$V_R = 600\text{ V}, I_F = 600\text{ A}, V_{GE} = -15\text{ V}, -di_F/dt = 11000\text{ A}/\mu\text{s} (T_{vj} = 150\text{ °C})$		$T_{vj} = 25\text{ °C}$	27	mJ	
				$T_{vj} = 125\text{ °C}$	48.5		
				$T_{vj} = 150\text{ °C}$	54.5		
Thermal resistance, junction to case	R_{thJC}	per diode			0.0929	K/W	
Thermal resistance, case to heatsink	R_{thCH}	per diode, $\lambda_{grease} = 1\text{ W}/(\text{m}^*\text{K})$			0.0303	K/W	
Temperature under switching conditions	$T_{vj\text{ op}}$		-40		150	$^{\circ}\text{C}$	

4 Characteristics diagrams

output characteristic (typical), IGBT, Inverter

$$I_C = f(V_{CE})$$

$$V_{GE} = 15 \text{ V}$$

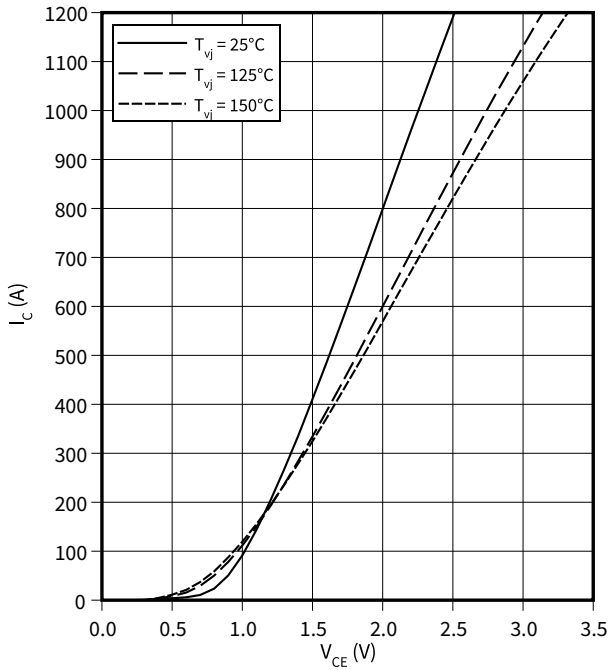

output characteristic (typical), IGBT, Inverter

$$I_C = f(V_{CE})$$

$$T_{vj} = 150^\circ\text{C}$$

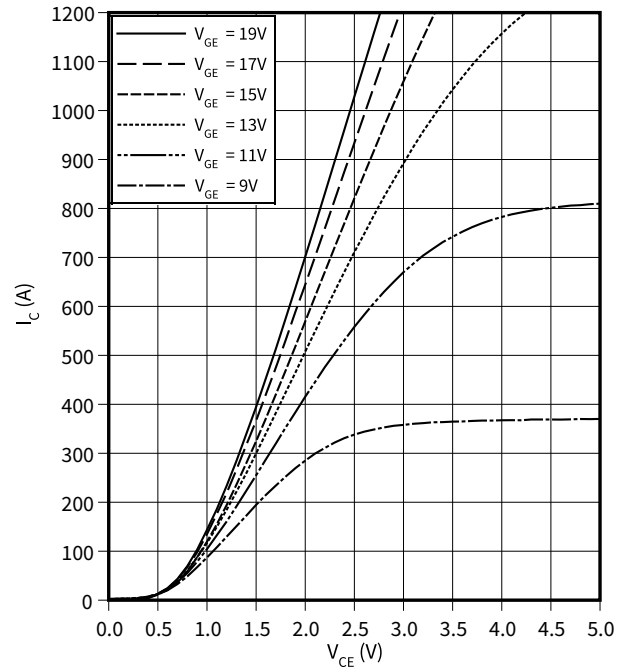

transfer characteristic (typical), IGBT, Inverter

$$I_C = f(V_{GE})$$

$$V_{CE} = 20 \text{ V}$$

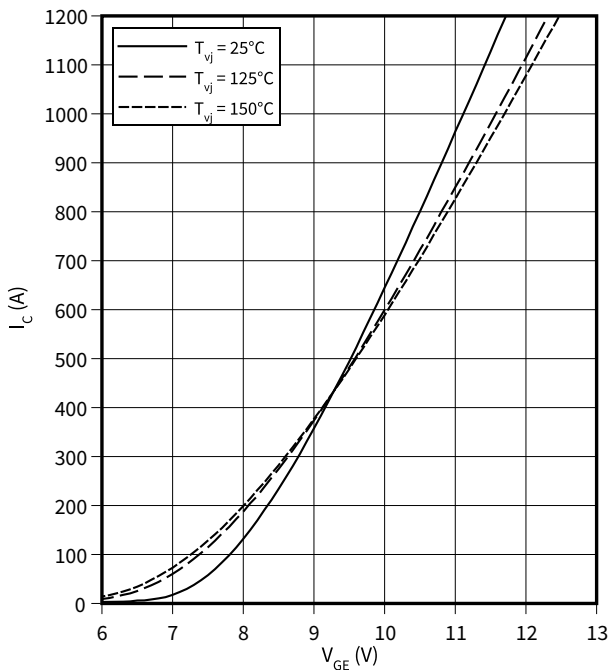

switching losses (typical), IGBT, Inverter

$$E = f(I_C)$$

$$R_{Goff} = 0.62 \Omega, R_{Gon} = 0.62 \Omega, V_{CE} = 600 \text{ V}, V_{GE} = \pm 15 \text{ V}$$

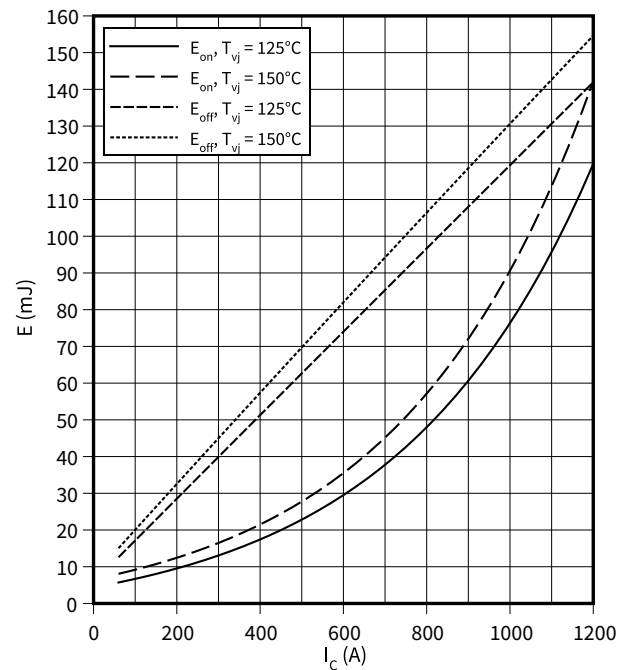

4 Characteristics diagrams

switching losses (typical), IGBT, Inverter

$E = f(R_G)$

$I_C = 600 \text{ A}$, $V_{CE} = 600 \text{ V}$, $V_{GE} = \pm 15 \text{ V}$

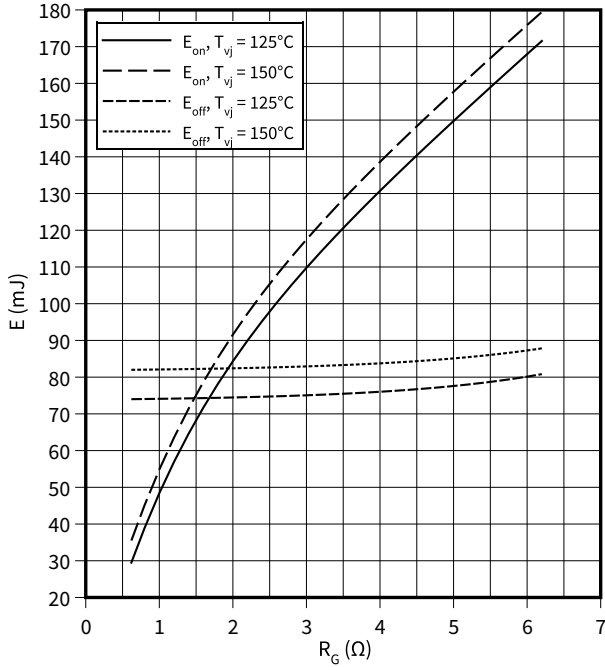

transient thermal impedance , IGBT, Inverter

$Z_{th} = f(t)$

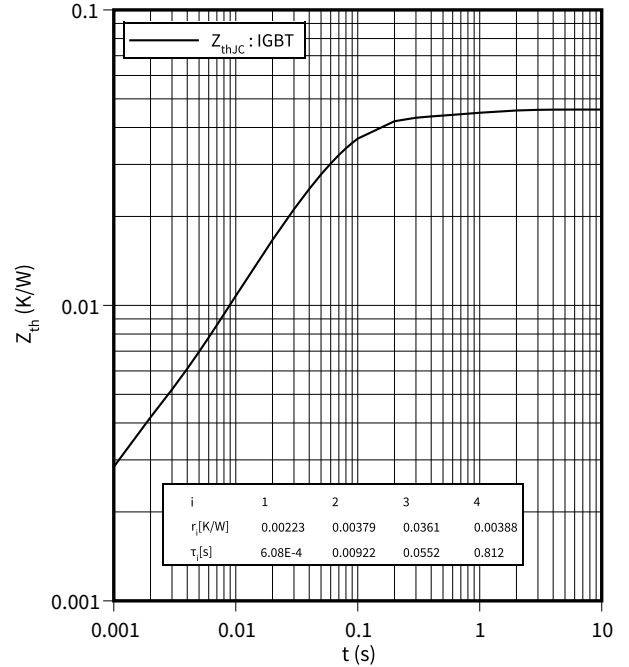

reverse bias safe operating area (RBSOA), IGBT, Inverter

$I_C = f(V_{CE})$

$R_{Goff} = 0.62 \Omega$, $V_{GE} = \pm 15.0 \text{ V}$, $T_{vj} = 150 \text{ °C}$

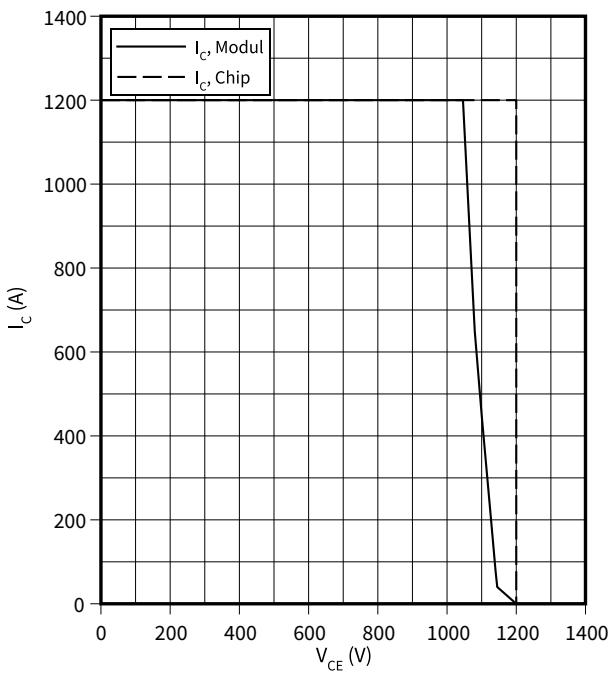

switching times (typical), IGBT, Inverter

$t = f(I_C)$

$R_{Goff} = 0.62 \Omega$, $R_{Gon} = 0.62 \Omega$, $V_{CE} = 600 \text{ V}$, $V_{GE} = \pm 15 \text{ V}$, $T_{vj} = 150 \text{ °C}$

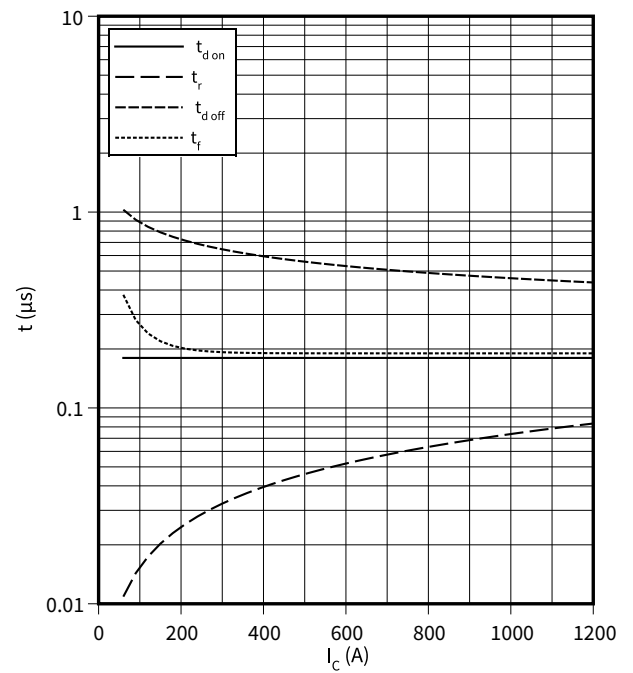

4 Characteristics diagrams

switching times (typical), IGBT, Inverter

$t = f(R_G)$

$I_C = 600 \text{ A}$, $V_{CE} = 600 \text{ V}$, $V_{GE} = \pm 15 \text{ V}$, $T_{vj} = 150 \text{ }^\circ\text{C}$

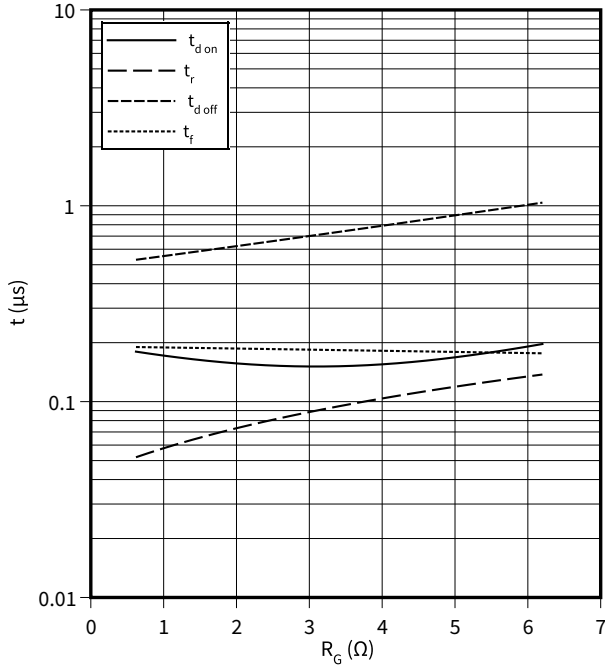

forward characteristic (typical), Diode, Inverter

$I_F = f(V_F)$

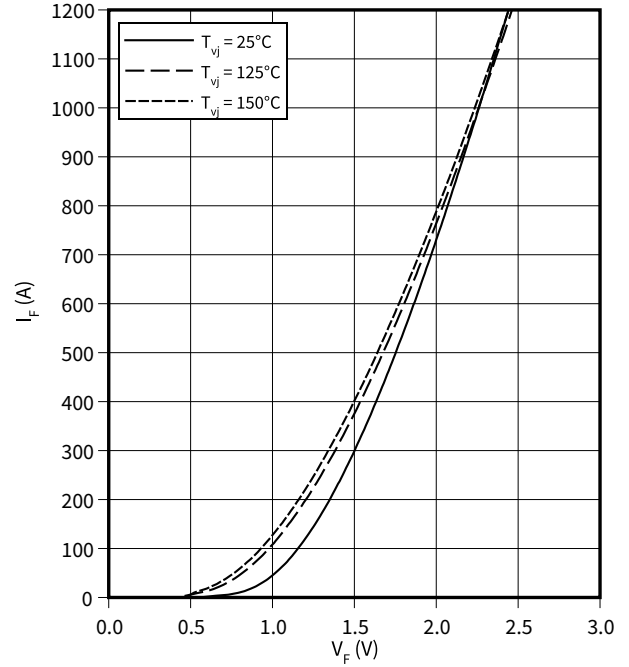

switching losses (typical), Diode, Inverter

$E_{rec} = f(I_F)$

$V_{CE} = 600 \text{ V}$, $R_{Gon} = R_{Gon}(\text{IGBT})$

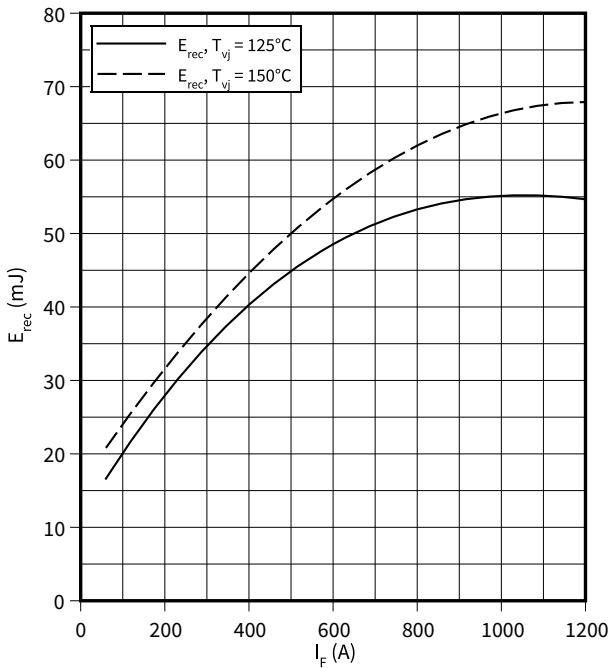

switching losses (typical), Diode, Inverter

$E_{rec} = f(R_G)$

$V_{CE} = 600 \text{ V}$, $I_F = 600 \text{ A}$

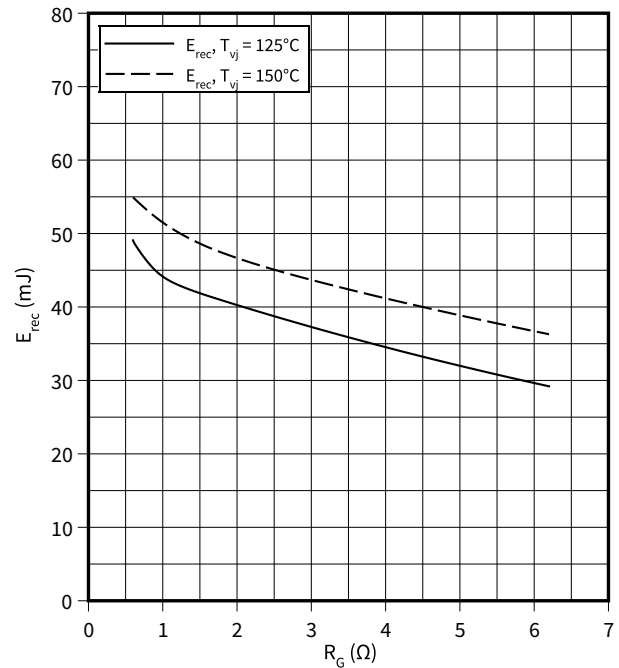

4 Characteristics diagrams

transient thermal impedance , Diode, Inverter

$Z_{th} = f(t)$

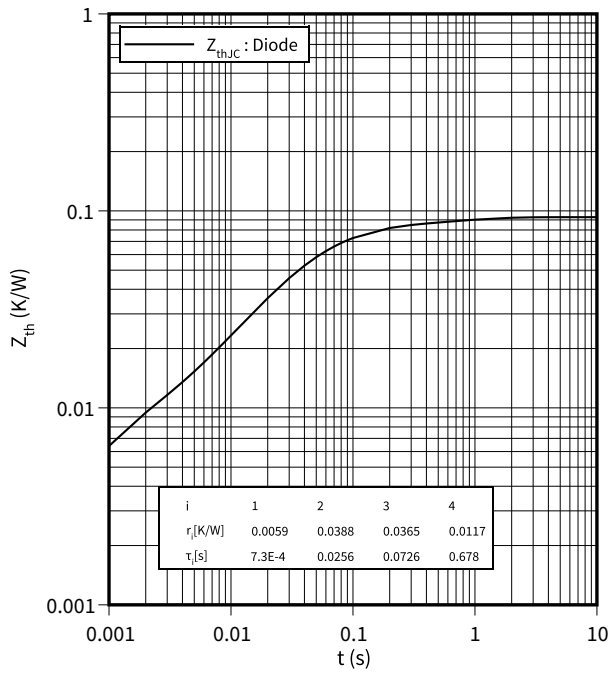

5 Circuit diagram

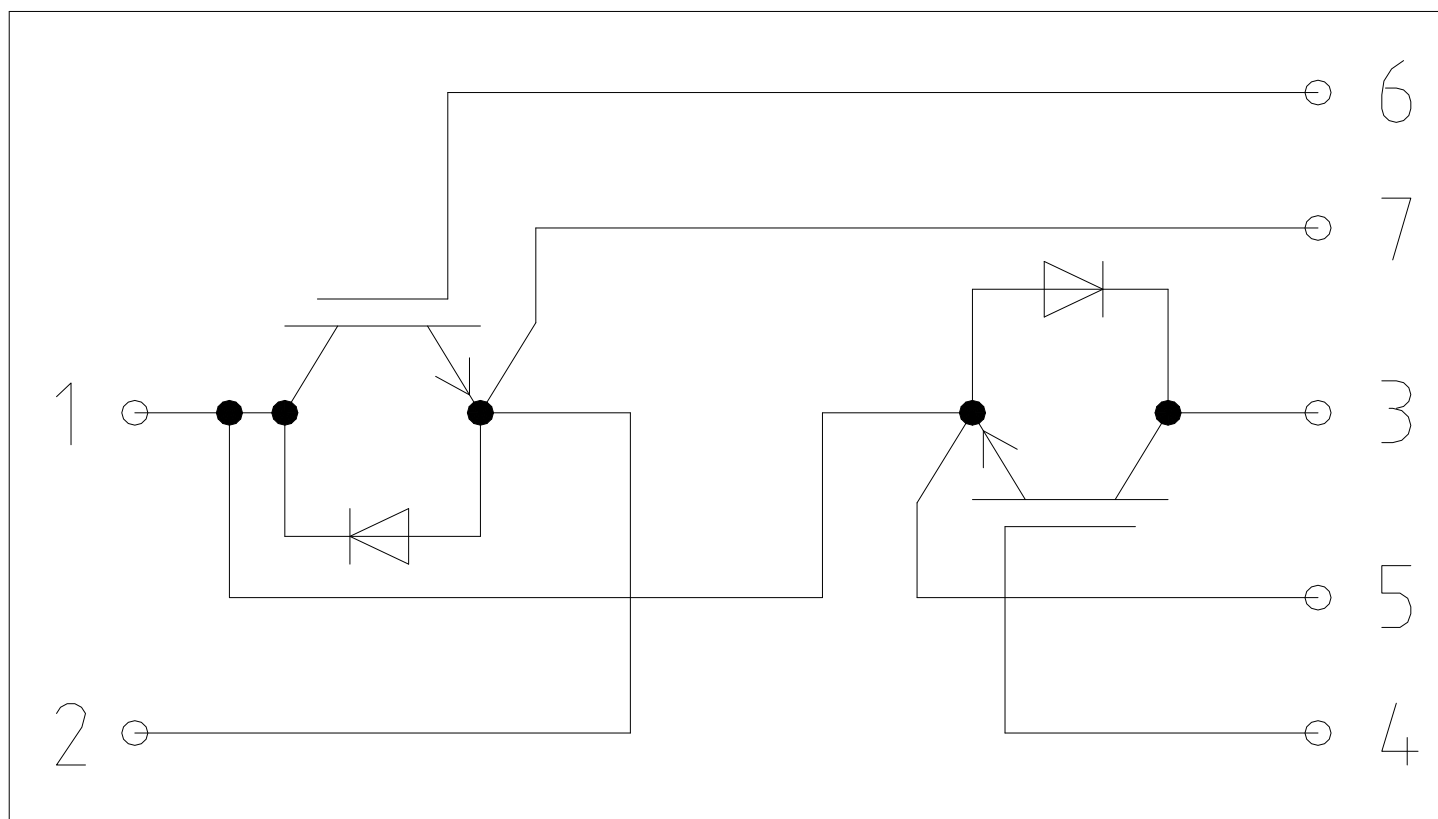

Figure 2

6 Package outlines

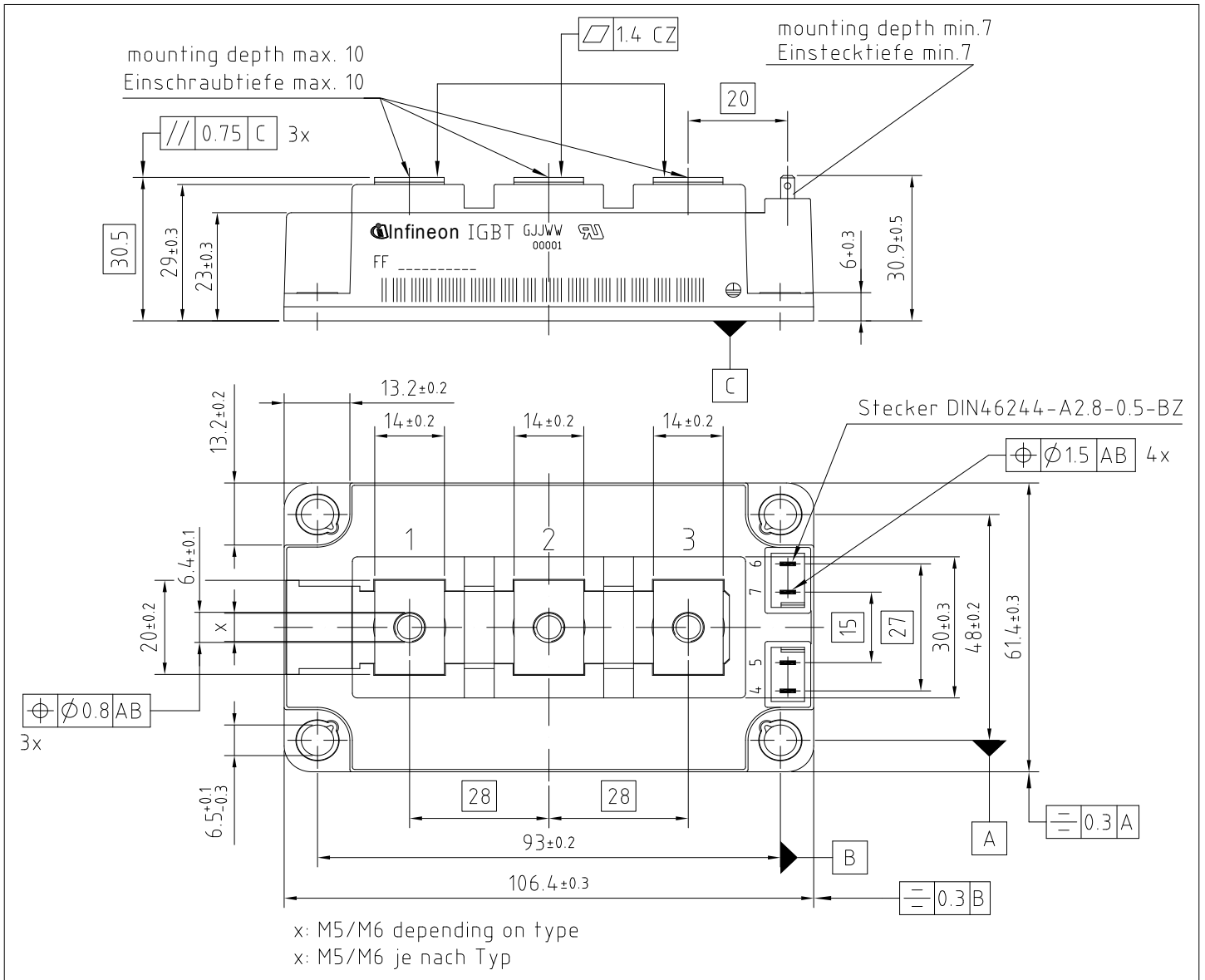

Figure 3

7 Module label code



Module label code			
Code format	Data Matrix	Barcode Code128	
Encoding	ASCII text	Code Set A	
Symbol size	16x16	23 digits	
Standard	IEC24720 and IEC16022	IEC8859-1	
Code content	Content	Digit	Example
	Module serial number	1 - 5	71549
	Module material number	6 - 11	142846
	Production order number	12 - 19	55054991
	Date code (production year)	20 - 21	15
	Date code (production week)	22 - 23	30
Example			
	71549142846550549911530		71549142846550549911530

Figure 4

Trademarks

All referenced product or service names and trademarks are the property of their respective owners.

Edition 2021-02-26

Published by

Infineon Technologies AG

81726 Munich, Germany

© 2021 Infineon Technologies AG

All Rights Reserved.

Do you have a question about any aspect of this document?

Email: erratum@infineon.com

Document reference

IFX-

IMPORTANT NOTICE

The information given in this document shall in no event be regarded as a guarantee of conditions or characteristics ("Beschaffheitsgarantie").

With respect to any examples, hints or any typical values stated herein and/or any information regarding the application of the product, Infineon Technologies hereby disclaims any and all warranties and liabilities of any kind, including without limitation warranties of non-infringement of intellectual property rights of any third party.

In addition, any information given in this document is subject to customer's compliance with its obligations stated in this document and any applicable legal requirements, norms and standards concerning customer's products and any use of the product of Infineon Technologies in customer's applications.

The data contained in this document is exclusively intended for technically trained staff. It is the responsibility of customer's technical departments to evaluate the suitability of the product for the intended application and the completeness of the product information given in this document with respect to such application.

Please note that this product is not qualified according to the AEC Q100 or AEC Q101 documents of the Automotive Electronics Council.

WARNINGS

Due to technical requirements products may contain dangerous substances. For information on the types in question please contact your nearest Infineon Technologies office.

Except as otherwise explicitly approved by Infineon Technologies in a written document signed by authorized representatives of Infineon Technologies, Infineon Technologies' products may not be used in any applications where a failure of the product or any consequences of the use thereof can reasonably be expected to result in personal injury.