

CARMEN-M-C-WHT

~35° wide beam. Assembly with holder C compatible with LEDiL HEKLA. White version.

SPECIFICATION:

Dimensions	Ø 69.5 mm
Height	41.5 mm
Fastening	socket
ROHS compliant	yes ⓘ

MATERIALS:

Component	Type	Material	Colour	Finish
CARMEN-M	Single lens	PMMA	clear	
CARMEN-HLD-C-WHT	Holder	PC	white	

ORDERING INFORMATION:





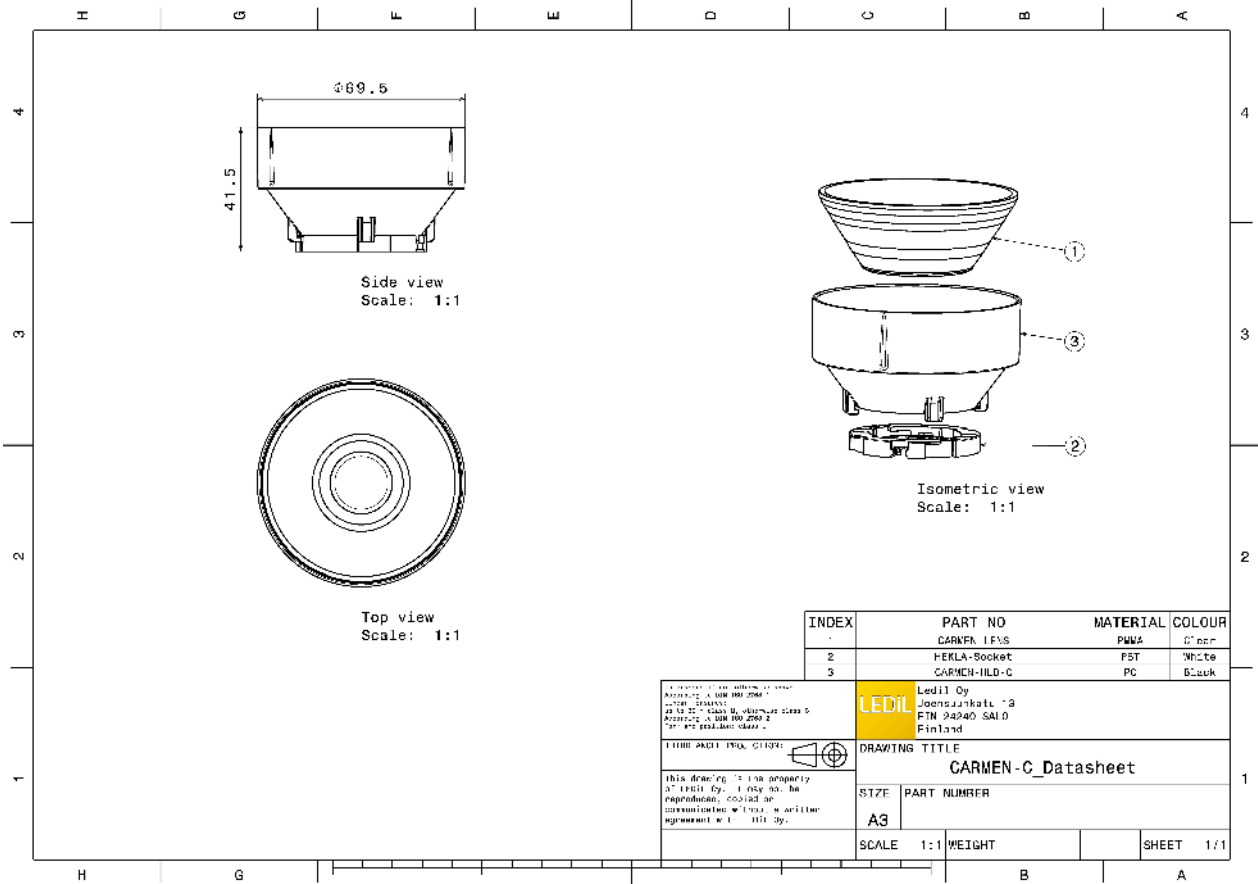

Component	Type	Qty in box	MOQ	MPQ	Box weight (kg)
CP16938_CARMEN-M-C-WHT » Box size: 476 x 273 x 292 mm	Single lens	150	150	15	6.1



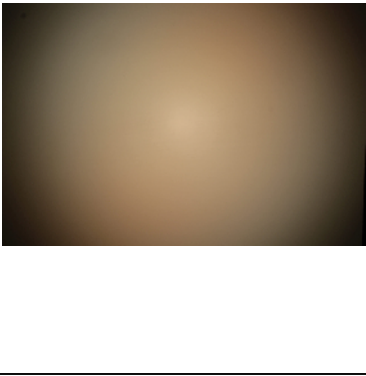
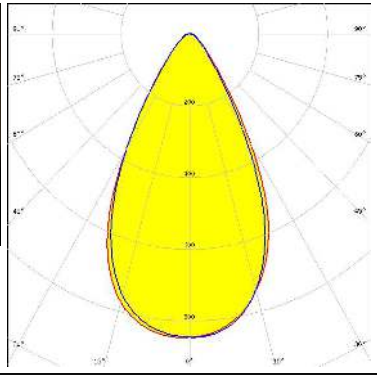

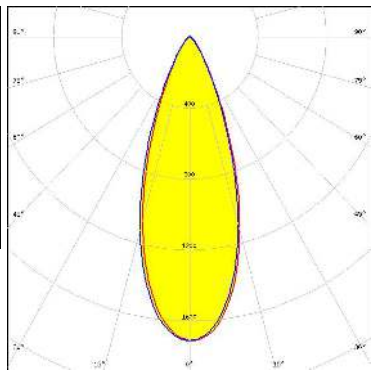
See also our general installation guide: www.ledil.com/installation_guide

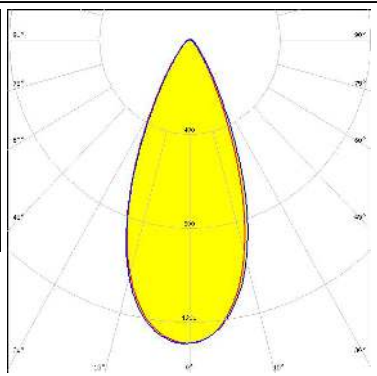
OPTICAL RESULTS (MEASURED):

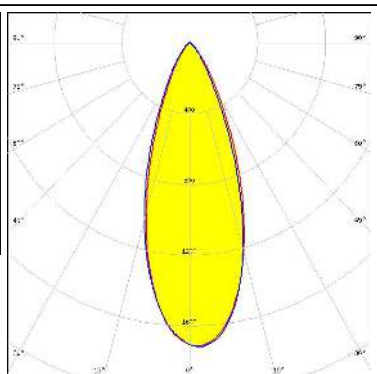
<p></p> <p>LED Vesta DTW 13mm (21W) FWHM / FWTM 56.0° / 86.0° Efficiency 79 % Peak intensity 0.8 cd/lm LEDs/each optic 1 Light colour Tunable White</p> <p>Required components: C16142_HEKLA-SOCKET-K Bender Wirth: 491 Typ L8</p>		
<p></p> <p>LED Vesta TW 6mm DP FWHM / FWTM 37.0° / 66.0° Efficiency 84 % Peak intensity 1.7 cd/lm LEDs/each optic 1 Light colour White</p> <p>Required components: C16142_HEKLA-SOCKET-K Bender Wirth: 504 Typ L8</p>		
<p></p> <p>LED Vesta TW 9mm (9W) DP FWHM / FWTM 44.0° / 73.0° Efficiency 83 % Peak intensity 1.3 cd/lm LEDs/each optic 1 Light colour White</p> <p>Required components: C16142_HEKLA-SOCKET-K Bender Wirth: 489 Typ L8</p>		
<p>CITIZEN</p> <p>LED CLU700/701/702/703 FWHM / FWTM 37.0° / 68.0° Efficiency 87 % Peak intensity 1.7 cd/lm LEDs/each optic 1 Light colour White</p> <p>Required components: F15255_HEKLA-SOCKET-C</p>		

OPTICAL RESULTS (MEASURED):

CITIZEN

LED CLU710/711
 FWHM / FWTM 42.0° / 70.0°
 Efficiency 85 %
 Peak intensity 1.5 cd/lm
 LEDs/each optic 1
 Light colour White
 Required components:
 F15859_HEKLA-SOCKET-I

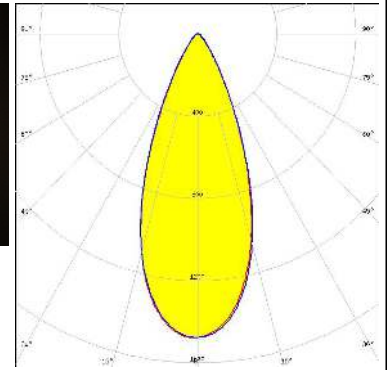

CITIZEN

LED CLU7B2
 FWHM / FWTM 36.0° / 64.0°
 Efficiency 90 %
 Peak intensity 2 cd/lm
 LEDs/each optic 1
 Light colour White
 Required components:
 F15255_HEKLA-SOCKET-C

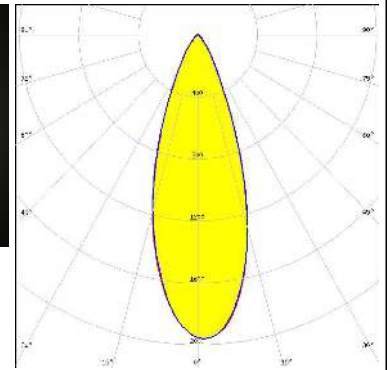
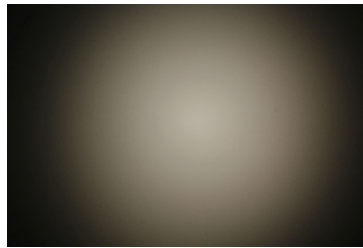

CREE LED

LED CXA/B 15xx
 FWHM / FWTM 44.0° / 75.0°
 Efficiency 86 %
 Peak intensity 1.4 cd/lm
 LEDs/each optic 1
 Light colour White
 Required components:
 F15256_HEKLA-SOCKET-D

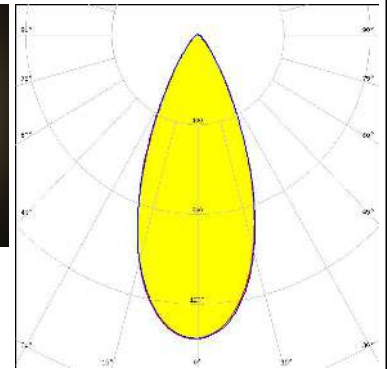
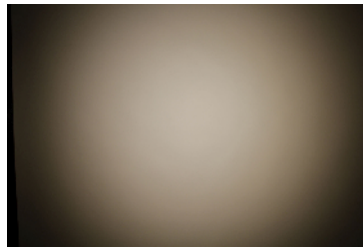



LUMILEDS

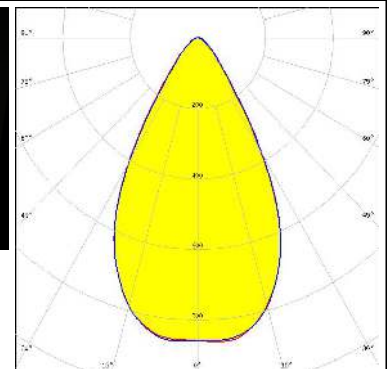
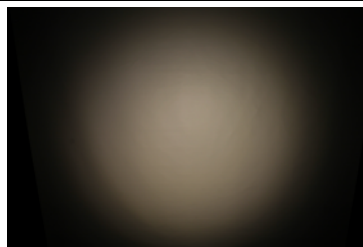

LED LUXEON CX Plus CoB L08 (Gen2)
 FWHM / FWTM 58.0° / 89.0°
 Efficiency 85 %
 Peak intensity 0.9 cd/lm
 LEDs/each optic 1
 Light colour White
 Required components:
 Bender Wirth: 637a Hekla

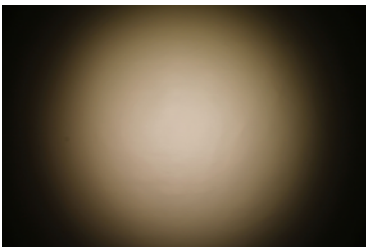
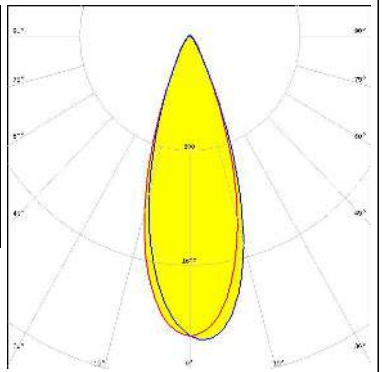
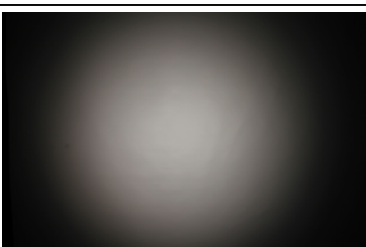
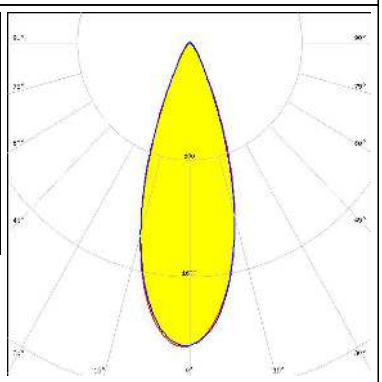
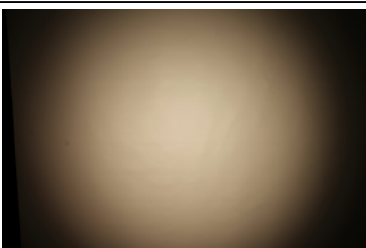
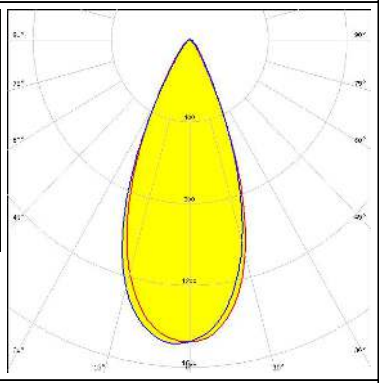

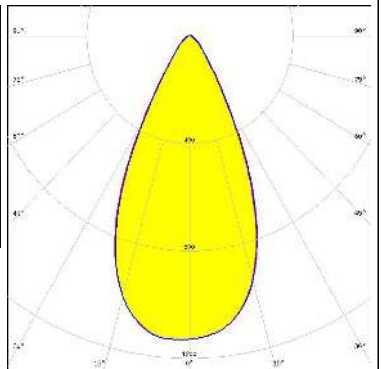

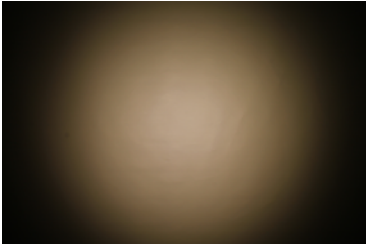
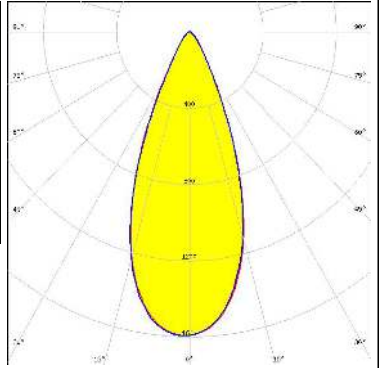
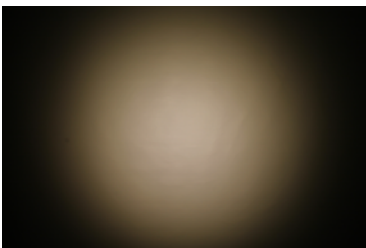
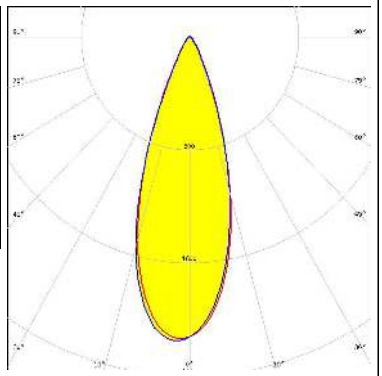

OPTICAL RESULTS (MEASURED):

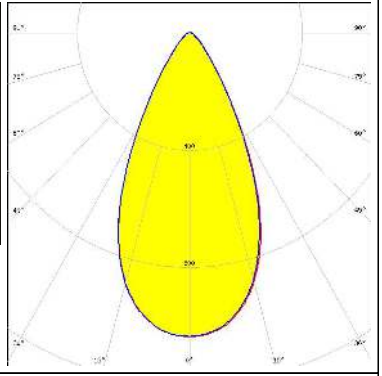
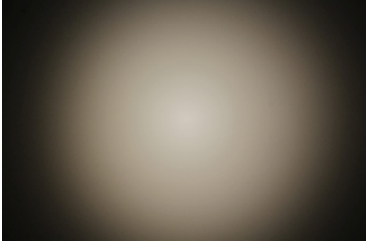
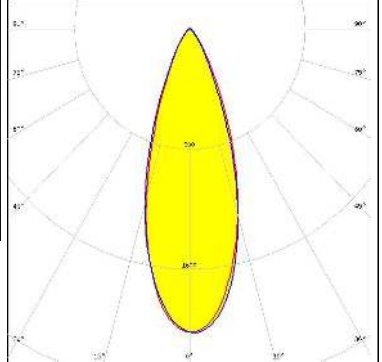
<p>LUMILEDS</p> <p>LED LUXEON CX Plus CoB - HD S01H4</p> <p>FWHM / FWTM 35.0° / 58.0°</p> <p>Efficiency 88 %</p> <p>Peak intensity 2.1 cd/m</p> <p>LEDs/each optic 1</p> <p>Light colour White</p> <p>Required components: Bender Wirth: 634c Hekla</p>		
<p>LUMILEDS</p> <p>LED LUXEON CX Plus CoB - HD S01H6 / HD S02H6</p> <p>FWHM / FWTM 35.0° / 59.0°</p> <p>Efficiency 89 %</p> <p>Peak intensity 2.1 cd/m</p> <p>LEDs/each optic 1</p> <p>Light colour White</p> <p>Required components: Bender Wirth: 634c Hekla</p>		
<p>LUMILEDS</p> <p>LED LUXEON CX Plus CoB - HD S04H9</p> <p>FWHM / FWTM 43.0° / 68.0°</p> <p>Efficiency 88 %</p> <p>Peak intensity 1.5 cd/m</p> <p>LEDs/each optic 1</p> <p>Light colour White</p> <p>Required components: Bender Wirth: 634c Hekla</p>		
<p>LUMILEDS</p> <p>LED LUXEON CX Plus CoB L04 / L05 (Gen2)</p> <p>FWHM / FWTM 50.0° / 77.0°</p> <p>Efficiency 86 %</p> <p>Peak intensity 1.1 cd/m</p> <p>LEDs/each optic 1</p> <p>Light colour White</p> <p>Required components: Bender Wirth: 637a Hekla</p>		

OPTICAL RESULTS (MEASURED):

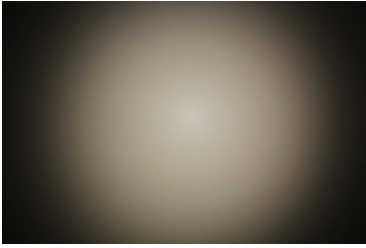
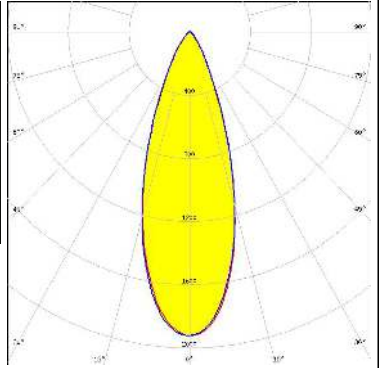
<p>LUMILEDS</p> <p>LED LUXEON CX Plus CoB M02 / M03 (Gen2)</p> <p>FWHM / FWTM 42.0° / 66.0°</p> <p>Efficiency 87 %</p> <p>Peak intensity 1.6 cd/lm</p> <p>LEDs/each optic 1</p> <p>Light colour White</p> <p>Required components: Bender Wirth: 641a Hekla</p>		
<p>LUMILEDS</p> <p>LED LUXEON CX Plus CoB S01 (Gen2)</p> <p>FWHM / FWTM 35.0° / 58.0°</p> <p>Efficiency 89 %</p> <p>Peak intensity 2.2 cd/lm</p> <p>LEDs/each optic 1</p> <p>Light colour White</p> <p>Required components: Bender Wirth: 634c Hekla</p>		
<p>LUMINUS</p> <p>LED CxM-11 (19x19)</p> <p>FWHM / FWTM 51.0° / 81.0°</p> <p>Efficiency 84 %</p> <p>Peak intensity 1 cd/lm</p> <p>LEDs/each optic 1</p> <p>Light colour White</p> <p>Required components: F15859_HEKLA-SOCKET-I</p>		
<p>LUMINUS</p> <p>LED CXM-3</p> <p>FWHM / FWTM 35.0° / 64.0°</p> <p>Efficiency 91 %</p> <p>Peak intensity 2 cd/lm</p> <p>LEDs/each optic 1</p> <p>Light colour White</p> <p>Required components: F15255_HEKLA-SOCKET-C</p>		

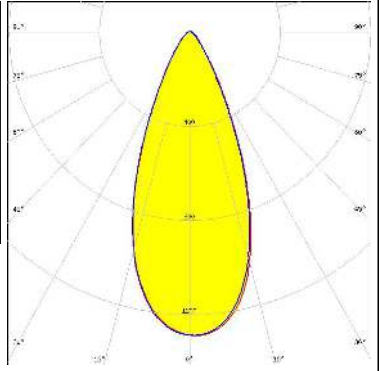
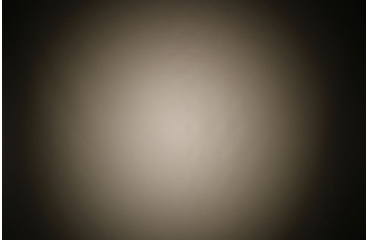
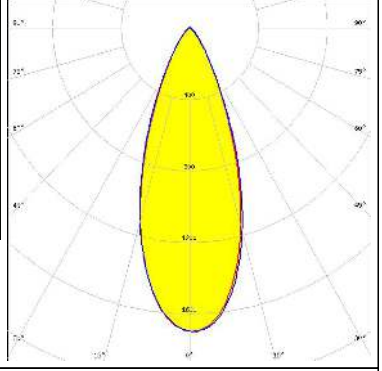
OPTICAL RESULTS (MEASURED):

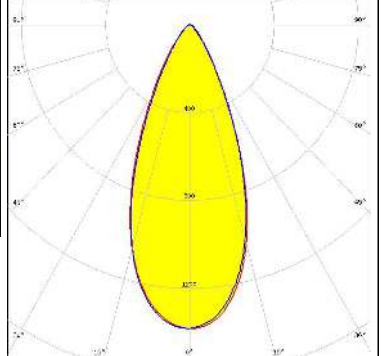
<p>LUMINUS</p> <p>LED CXM-4 FWHM / FWTM 35.0° / 65.0° Efficiency 88 % Peak intensity 1.9 cd/m LEDs/each optic 1 Light colour White Required components: F15255_HEKLA-SOCKET-C</p>		
<p>SAMSUNG</p> <p>LED LC010T (Tunable White) FWHM / FWTM 43.0° / 74.0° Efficiency 82 % Peak intensity 1.3 cd/m LEDs/each optic 1 Light colour Tunable White Required components: C16142_HEKLA-SOCKET-K Bender Wirth: 501 Typ L8</p>		
<p>XICATO</p> <p>LED XOB 6 mm FWHM / FWTM 39.0° / 69.0° Efficiency 87 % Peak intensity 1.7 cd/m LEDs/each optic 1 Light colour White Required components: F15255_HEKLA-SOCKET-C</p>		
<p>XICATO</p> <p>LED XOB 9.8 mm FWHM / FWTM 43.0° / 74.0° Efficiency 86 % Peak intensity 1.4 cd/m LEDs/each optic 1 Light colour White Required components: F15255_HEKLA-SOCKET-C</p>		

OPTICAL RESULTS (SIMULATED):

CITIZEN

LED CLL02x/CLU02x (LES10)
 FWHM / FWTM 44.0° / 69.0°
 Efficiency 88 %
 Peak intensity 1.5 cd/lm
 LEDs/each optic 1
 Light colour White
 Required components:

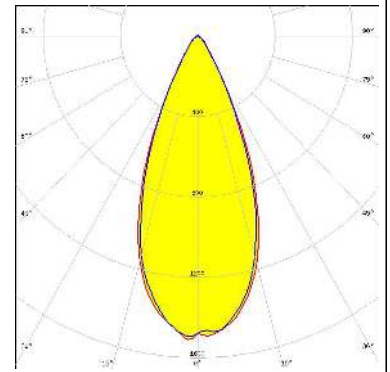

CREE LED

LED CMU15xx
 FWHM / FWTM 54.0° / 86.0°
 Efficiency 71 %
 Peak intensity 0.9 cd/lm
 LEDs/each optic 1
 Light colour White
 Required components:
 F17438_HEKLA-G2-I

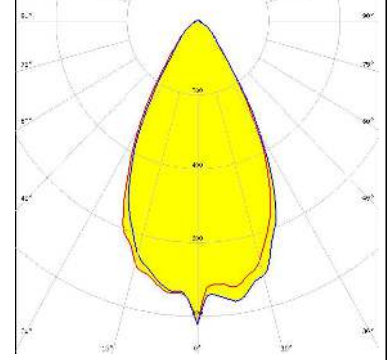

NICHIA

LED COB S-Type (LES 7)
 FWHM / FWTM 38.0° / 60.0°
 Efficiency 84 %
 Peak intensity 1.9 cd/lm
 LEDs/each optic 1
 Light colour White
 Required components:
 F15848_HEKLA-SOCKET-G

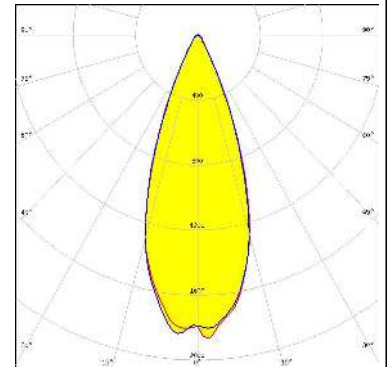

TRIDONIC

LED SLE G7 LES09
 FWHM / FWTM 41.0° / 66.0°
 Efficiency 84 %
 Peak intensity 1.6 cd/lm
 LEDs/each optic 1
 Light colour White
 Required components:
 F15255_HEKLA-SOCKET-C

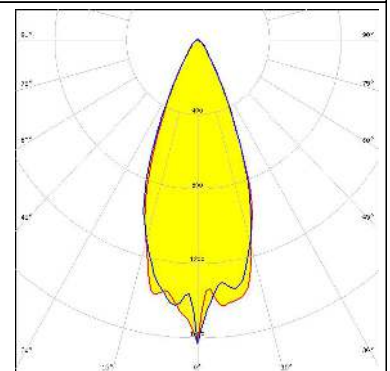

GENERAL INFORMATION:

NOTE: The typical beam angle will be changed by different color, chip size and chip position tolerance. The typical total beam angle is the full angle measured where the luminous intensity is half of the peak value.

Due to use of high power COB's with this product, special attention to proper thermal design is highly recommended. LEDiL has no liability for direct, indirect or consecutive damages arising from the LEDiL products being used outside of the recommended temperature range.

MATERIALS:

As part of our continuous research and improvement processes, and to ensure the best possible quality and availability of our products, LEDiL reserves the right to change material grades without notice.

PRODUCT DATA USER AGREEMENT AND DISCLAIMER:

The measured data in the provided downloadable LEDiL Product Datasheets and Mechanical 2D-Drawings is rounded and provided as reference for planning. LEDiL Oy's optical specifications have been verified by conducting performance testing of the products in accordance with the company's quality system. The reported data are averaged results of multiple measurements with typical variation. LEDiL Oy reserves the right to without prior notification make changes and improvements to its products.

LEDiL Oy assumes neither warranty, nor guarantee nor any other liability of any kind for the contents and correctness of the provided data. The provided data has been generated with highest diligence but the provided data may in reality not represent the complete possible variation range of all intrinsic parameters. Therefore, in certain cases a deviation from the provided data could occur.

LEDiL Oy reserves the right to undertake technical changes of its products without further notification which could lead to changes in the provided data. LEDiL Oy assumes no liability of any kind for the possible deviation from any provided data or any other damage resulting from the usage of the provided data.

The user agrees to this disclaimer and user agreement with the download or usage of the provided files.

LEDiL Oy

Joensuunkatu 13
FI-24240 SALO
Finland

LEDiL Inc.

228 West Page Street
Suite D
Sycamore IL 60178
USA

Ledil Optics Technology (Shenzhen) Co., Ltd.

405 , Block B
Casic Motor Building
Shenzhen 518057
P.R.CHINA

Local sales and technical support

[www.ledil.com/
where_to_buy](http://www.ledil.com/where_to_buy)

Shipping locations

Salo, Finland
Hong Kong, China

Distribution Partners

[www.ledil.com/
where_to_buy](http://www.ledil.com/where_to_buy)