

167301-4 ✓ ACTIVE

AMPMODU | AMPMODU IV/V

TE Internal #: 167301-4

Connector Contact, Socket, Wire-to-Board, 24 – 20 AWG Wire Size,
394.71 – 1184.12 CMA Wire Size, .2 – .6 mm² Wire Size, Gold, Reel,
AMPMODU IV/V

[View on TE.com >](#)



Connectors > PCB Connectors > Wire-to-Board Connectors > Wire-to-Board Connector Contacts



Contact Type: **Socket**

Connector System: **Wire-to-Board**

Wire Size: **.2 – .6 mm²**

Features

Product Type Features

Applied Pressure	Intermediate
Connector System	Wire-to-Board
Connector & Contact Terminates To	Wire & Cable

Configuration Features

Compatible With Wire & Cable Type	Discrete Wire
-----------------------------------	---------------

Contact Features

Mating Square Post Dimension	.64 mm[.025 in]
Wire Contact Termination Area Plating Material	Gold Flash
	30 μin
Contact Base Material	Phosphor Bronze
Contact Type	Socket
Contact Mating Area Plating Material	Gold
Contact Current Rating (Max)	3 A

Termination Features

Termination Method to Wire & Cable	Crimp
------------------------------------	-------



Mechanical Attachment

Wire Insulation Support	With
-------------------------	------

Dimensions

Compatible Insulation Diameter Range	1.4 mm[.055 in]
Wire Size	.2 – .6 mm ²

Usage Conditions

Operating Temperature Range	-65 – 105 °C[-85 – 221 °F]
-----------------------------	----------------------------

Operation/Application

Circuit Application	Power & Signal
---------------------	----------------

Packaging Features

Packaging Quantity	17500
Packaging Method	Reel

Other

Connector Contacts Comment	For 0.63 mm "Round" Post and 0.63 x 0.63 mm "Square" Post.
----------------------------	--

Product Compliance

[For compliance documentation, visit the product page on TE.com>](#)

EU RoHS Directive 2011/65/EU	Compliant
EU ELV Directive 2000/53/EC	Compliant
China RoHS 2 Directive MIIT Order No 32, 2016	No Restricted Materials Above Threshold
EU REACH Regulation (EC) No. 1907/2006	Current ECHA Candidate List: JUNE 2023 (235) Candidate List Declared Against: JAN 2023 (233) Does not contain REACH SVHC
Halogen Content	Low Halogen - Br, Cl, F, I < 900 ppm per homogenous material. Also BFR/CFR/PVC Free
Solder Process Capability	Not applicable for solder process capability

Product Compliance Disclaimer

This information is provided based on reasonable inquiry of our suppliers and represents our current actual knowledge based on the information they provided. This information is subject to change. The part numbers that TE has identified as EU RoHS compliant have a maximum concentration of 0.1% by weight in homogenous materials for lead, hexavalent chromium, mercury, PBB, PBDE, DBP, BBP, DEHP, DIBP, and 0.01% for cadmium, or qualify for an exemption to these limits as defined in the Annexes of Directive 2011/65/EU (RoHS2). Finished electrical and electronic equipment products will be CE marked as required by Directive 2011/65/EU. Components may not be CE marked. Additionally, the part

numbers that TE has identified as EU ELV compliant have a maximum concentration of 0.1% by weight in homogenous materials for lead, hexavalent chromium, and mercury, and 0.01% for cadmium, or qualify for an exemption to these limits as defined in the Annexes of Directive 2000/53/EC (ELV). Regarding the REACH Regulation, the information TE provides on SVHC in articles for this part number is based on the latest European Chemicals Agency (ECHA) 'Guidance on requirements for substances in articles' posted at this URL: <https://echa.europa.eu/guidance-documents/guidance-on-reach>

Compatible Parts

 <p>TE Part # 925370-5 MOD IV REC HSG 2X5P.</p>	 <p>TE Part # 925366-8 MOD 4 REC.HSG 1X08P</p>	 <p>TE Part # 926476-3 MOD 4 HSG</p>	 <p>TE Part # 925370-6 MOD.IV REC HSG, 2X6P</p>
 <p>TE Part # 926476-8 MOD 4 HSG</p>	 <p>TE Part # 925369-4 MOD IV HSG</p>	 <p>TE Part # 926475-3 03P MODU 4 HSG.S.R.</p>	 <p>TE Part # 926475-4 MOD 4 HSG</p>
 <p>TE Part # 925369-3 MOD 4 REC.HSG 1X03P</p>	 <p>TE Part # 925369-6 MOD 4 REC.HSG 1X06P</p>	 <p>TE Part # 925370-2 MOD IV REC HSG, 2X2P</p>	 <p>TE Part # 925369-2 MOD 4 REC.HSG 1X02P</p>
 <p>TE Part # 925366-2 MOD 4 REC.HSG 1X02P</p>	 <p>TE Part # 925370-4 MOD IV REC HSG 2X4 POS</p>	 <p>TE Part # 925367-4 MOD 4 REC.HSG 2X04P</p>	 <p>TE Part # 925369-5 MOD 4 REC.HSG 1X05P</p>

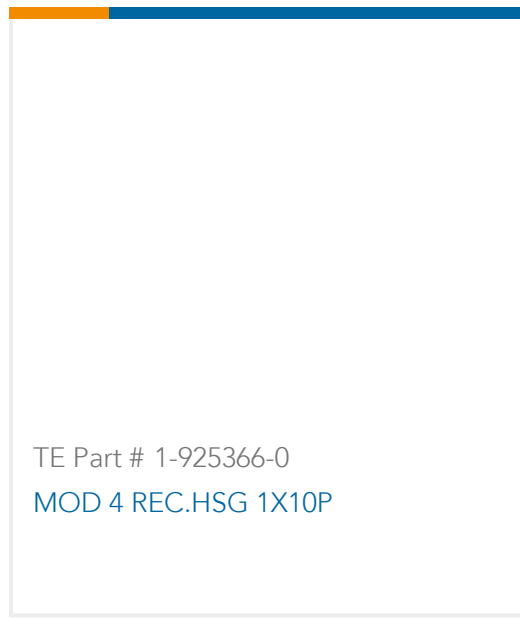

Also in the Series | AMPMODU IV/V

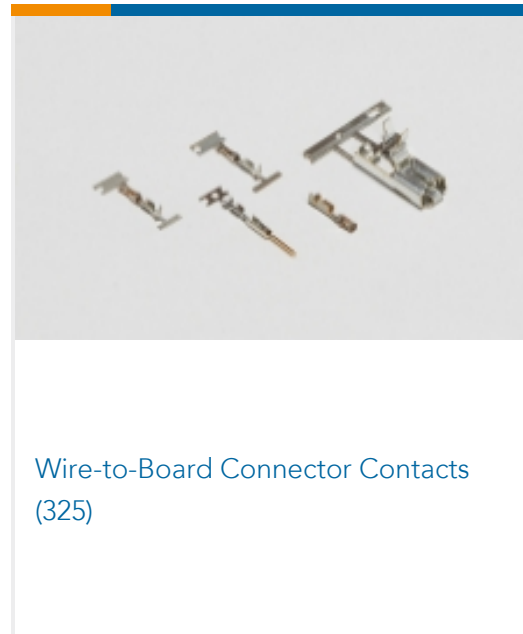
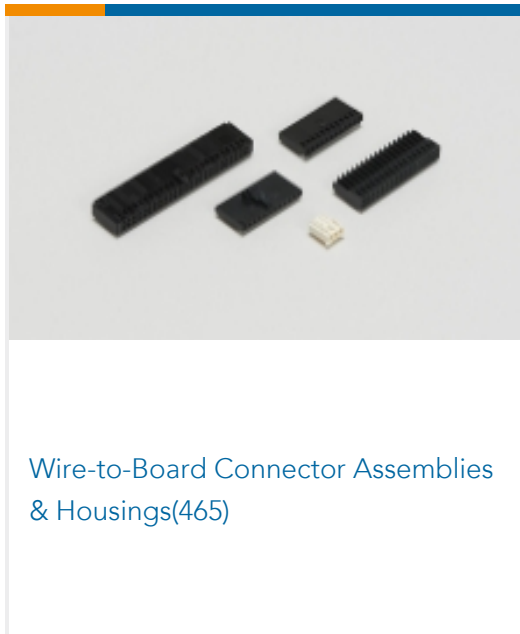
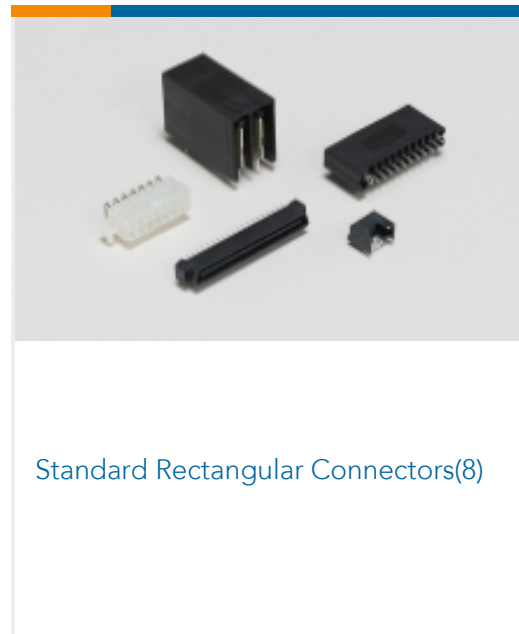
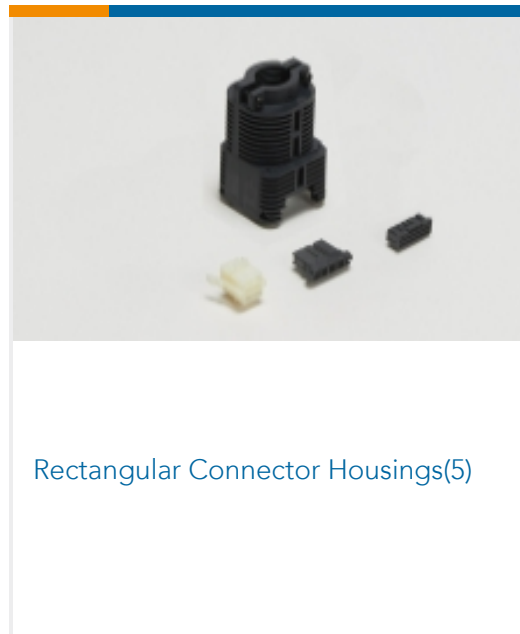
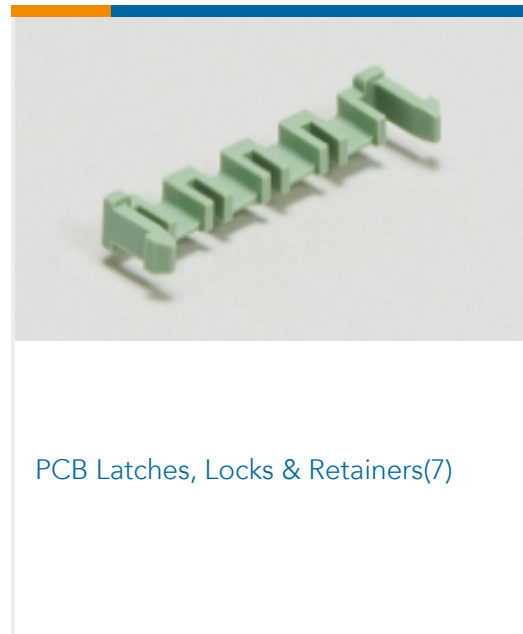
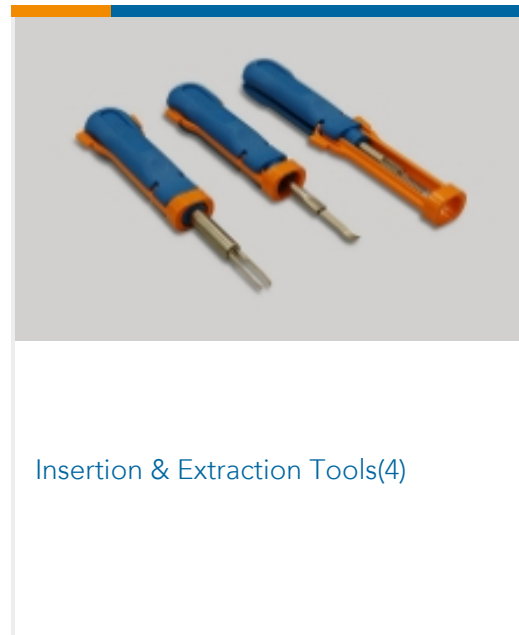
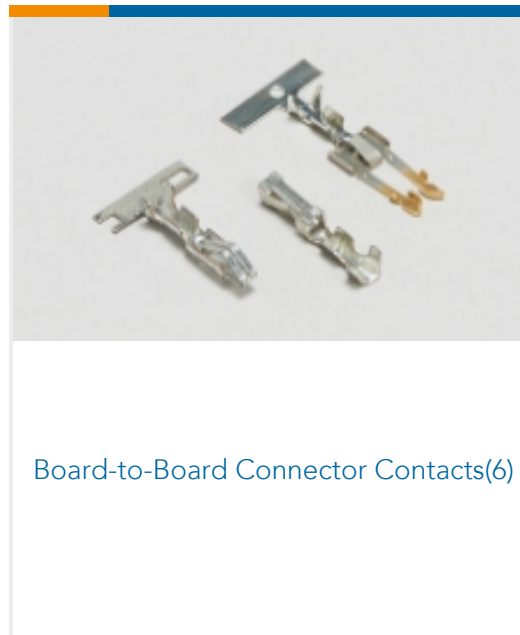
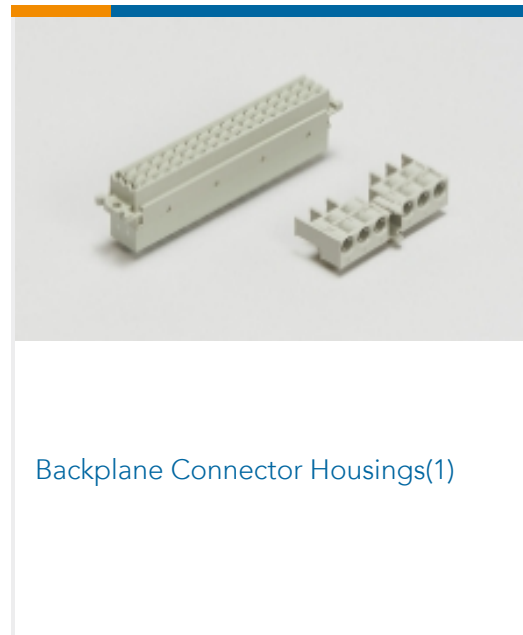
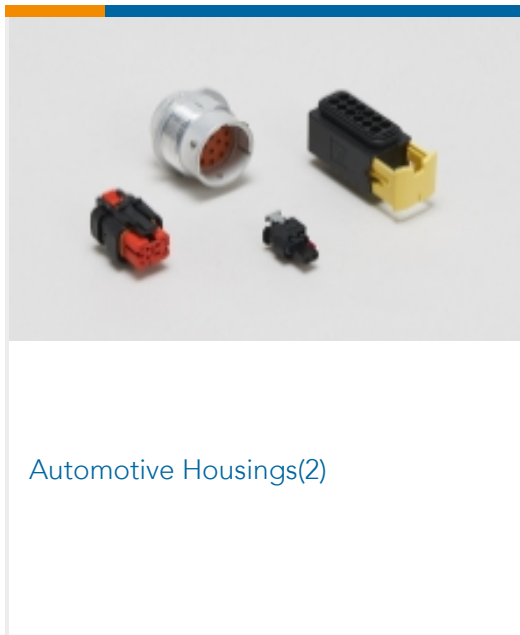

Customers Also Bought

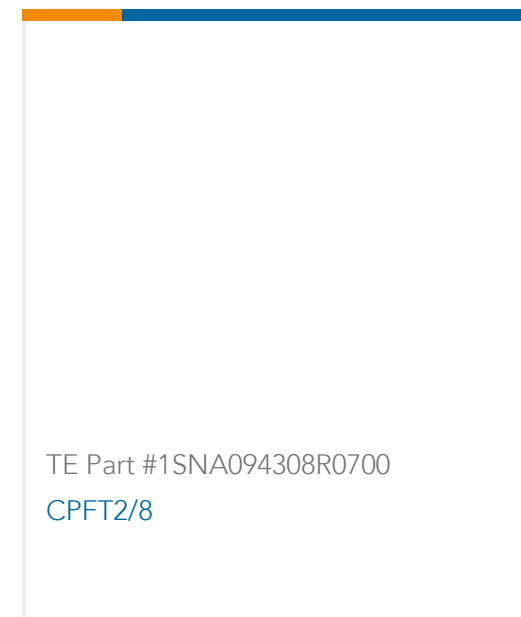
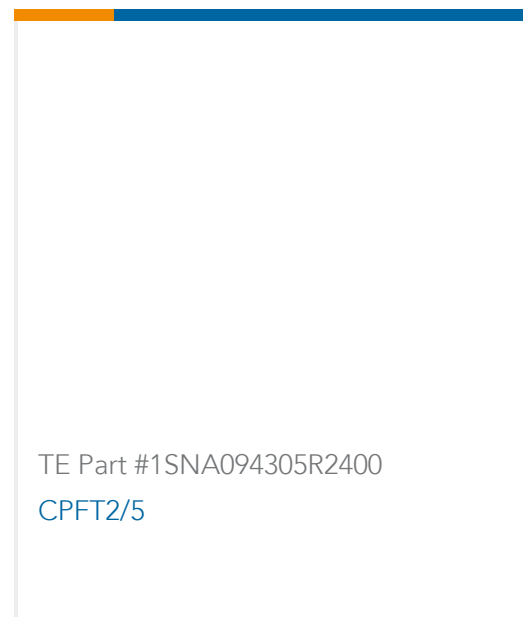
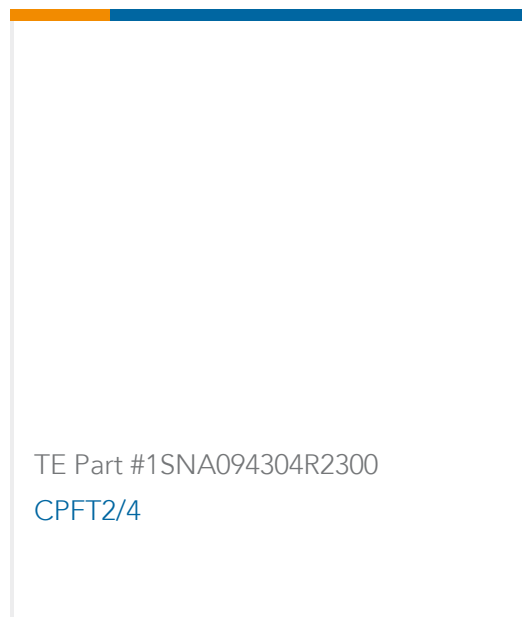
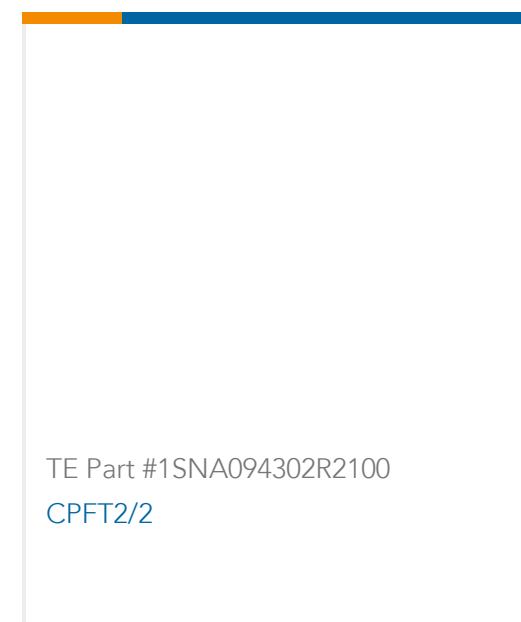
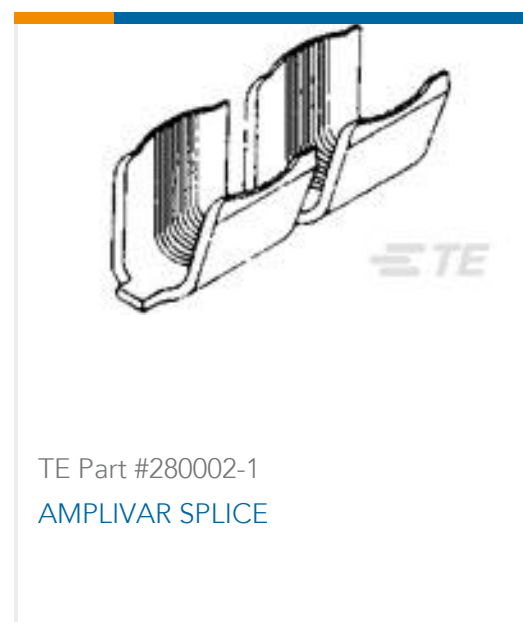

Documents

Product Drawings

[MOD-4 REC.CONT.SCP](#)

English

CAD Files

[3D PDF](#)

English

Customer View Model

[ENG_CVM_167301-4_J.3d_igs.zip](#)

English

Customer View Model

[ENG_CVM_167301-4_J.3d_stp.zip](#)

English

Customer View Model

[ENG_CVM_167301-4_J.2d_dxf.zip](#)

English

By downloading the CAD file I accept and agree to the [Terms and Conditions](#) of use.

Product Environmental Compliance

167301-4

Connector Contact, Socket, Wire-to-Board, 24 – 20 AWG Wire Size, 394.71 – 1184.12
CMA Wire Size, .2 – .6 mm² Wire Size, Gold, Reel, AMPMODU IV/V



[MD_167301-4_07102018102_dmtec](#)

English

[MD_167301-4_07102018102_dmtec](#)

English