

N-Channel Enhancement MOSFET

■ Features

- $V_{DS(V)} = 20V$
- $I_D = 4.2A (V_{GS}=4.5V)$
- $R_{DS(ON)} < 26m\Omega (V_{GS} = 4.5V)$
- $R_{DS(ON)} < 36m\Omega (V_{GS} = 2.5V)$
- $R_{DS(ON)} < 57m\Omega (V_{GS} = 1.8V)$

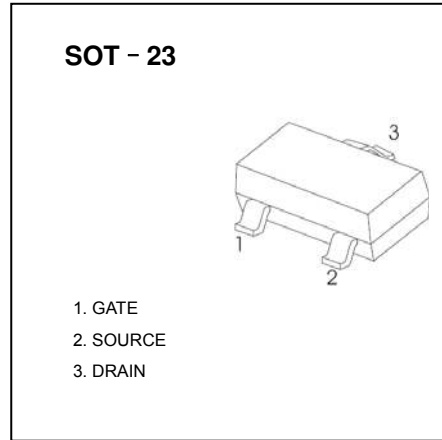
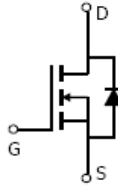

■ Absolute Maximum Ratings $T_a = 25^\circ C$

Parameter	Symbol	Rating	Unit
Drain-Source Voltage	V_{DS}	20	V
Gate-Source Voltage	V_{GS}	± 8	V
Continuous Drain Current *1 $T_A=25^\circ C$	I_D	4.2	A
Current *1 $T_A=70^\circ C$		3.2	
Pulsed Drain Current *2	I_{DM}	15	
Power Dissipation *1 $T_A=25^\circ C$	P_D	1.4	W
$T_A=70^\circ C$		0.9	
Thermal Resistance.Junction-to-Ambient *1	R_{thJA}	125	$^\circ C/W$
Thermal Resistance.Junction-to-Case	R_{thJC}	80	$^\circ C/W$
Junction and Storage Temperature Range	T_J, T_{STG}	-55 to 150	$^\circ C$

*1The value of R_{thJA} is measured with the device mounted on $1in^2$ FR-4 board with 2oz.

Copper, in a still air environment with $T_A = 25^\circ C$

Electrical Characteristics Ta = 25 °C

Parameter	Symbol	Testconditions	Min	Typ	Max	Unit
Drain-Source Breakdown Voltage	V _{DSS}	I _D =250uA, V _{GS} =0V	20			V
Zero Gate Voltage Drain Current	I _{DSS}	V _{DS} =16V, V _{GS} =0V			1	μ A
		V _{DS} =16V, V _{GS} =0V, T _J =55 °C			5	
Gate-Body leakage current	I _{GSS}	V _{DS} =0V, V _{GS} =± 8V			± 100	nA
Gate Threshold Voltage	V _{GS(th)}	V _{DS} =V _{GS} I _D =250uA	0.4	0.6	1	V
Static Drain-Source On-Resistance	R _{DS(ON)}	V _{GS} =4.5V, I _D =4.2A		23	26	m Ω
		V _{GS} =2.5V, I _D =3.7A		32	36	
		V _{GS} =1.8V, I _D =3.2A		48	57	
On state drain current	I _{D(ON)}	V _{GS} =4.5V, V _{DS} =5V	15			A
Forward Transconductance	g _{FS}	V _{DS} =5V, I _D =4.2A		11		S
Input Capacitance	C _{iss}	V _{GS} =0V, V _{DS} =-10V, f=1MHz		436		pF
Output Capacitance	C _{oss}			66		pF
Reverse Transfer Capacitance	C _{rss}			44		pF
Gate resistance	R _g	V _{GS} =0V, V _{DS} =0V, f=1MHz		3		Ω
Total Gate Charge	Q _g	V _{GS} =4.5V, V _{DS} =10V, I _D =4.2A		6.2		nC
Gate Source Charge	Q _{gs}			1.6		nC
Gate Drain Charge	Q _{gd}			0.5		nC
Turn-On DelayTime	t _{D(on)}	V _{GS} =4.5V, V _{DS} =10V, R _L =2.7Ω, R _{GEN} =6Ω		5.5		ns
Turn-On Rise Time	t _r			6.3		ns
Turn-Off DelayTime	t _{D(off)}			40		ns
Turn-Off FallTime	t _f			12.7		ns
Body Diode Reverse Recovery Time	t _{rr}	I _F =4A, di/dt=100A/μ s		12.3		ns
Body Diode Reverse Recovery Charge	Q _{rr}	I _F =4A, di/dt=100A/μ s		3.5		nC
Maximum Body-Diode Continuous Current	I _S				2	A
Diode Forward Voltage	V _{SD}	I _S =1A, V _{GS} =0V		0.76	1	V

■ Typical Characteristics

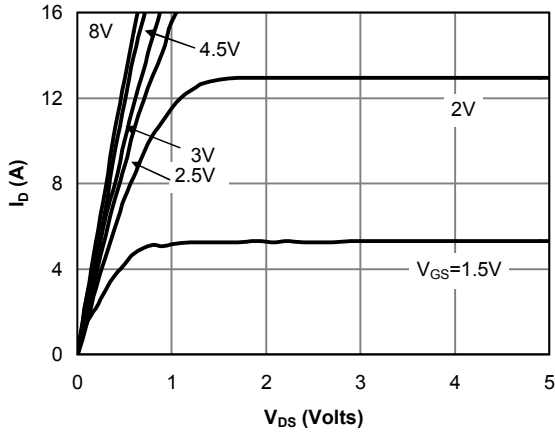

Fig 1: On-Region Characteristics

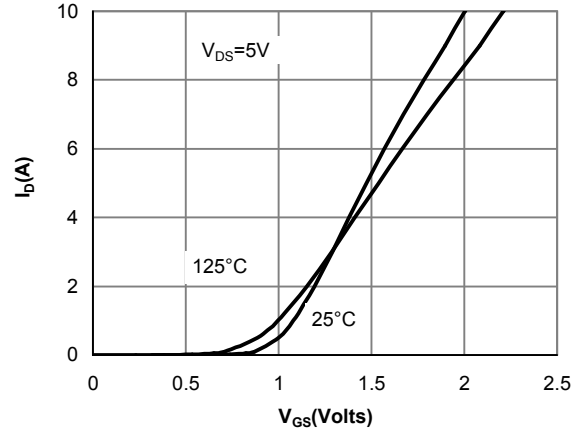

Figure 2: Transfer Characteristics

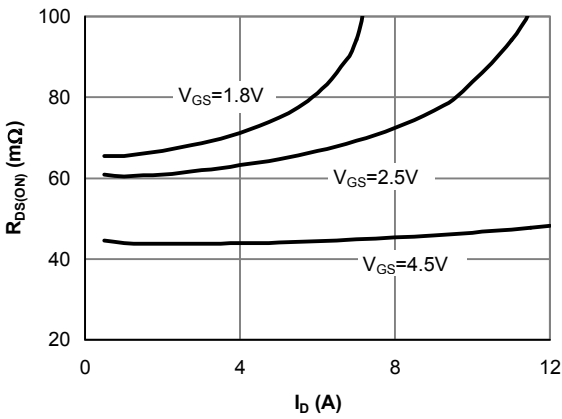

Figure 3: On-Resistance vs. Drain Current and Gate Voltage

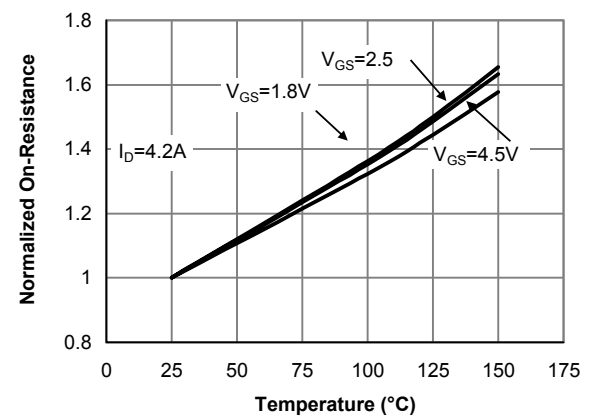

Figure 4: On-Resistance vs. Junction Temperature

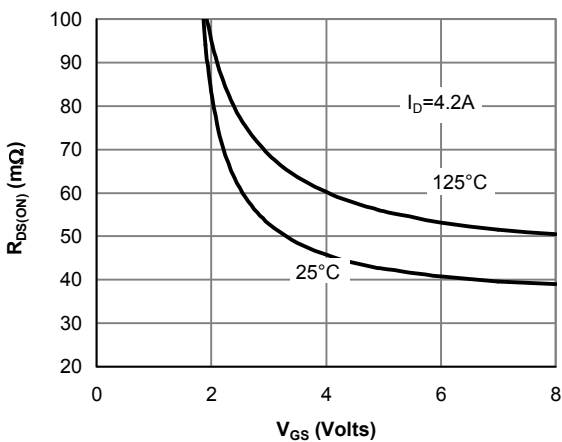

Figure 5: On-Resistance vs. Gate-Source Voltage

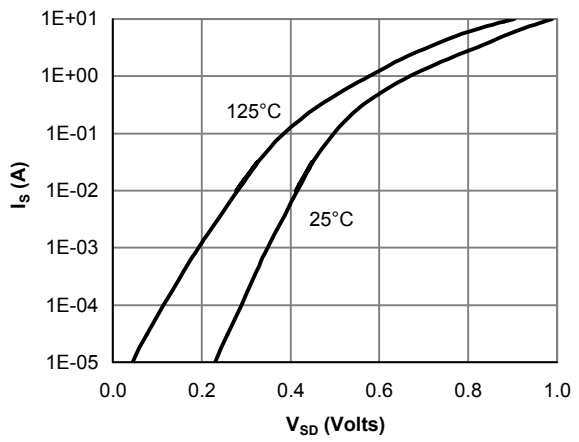

Figure 6: Body-Diode Characteristics

■ Typical Characteristics

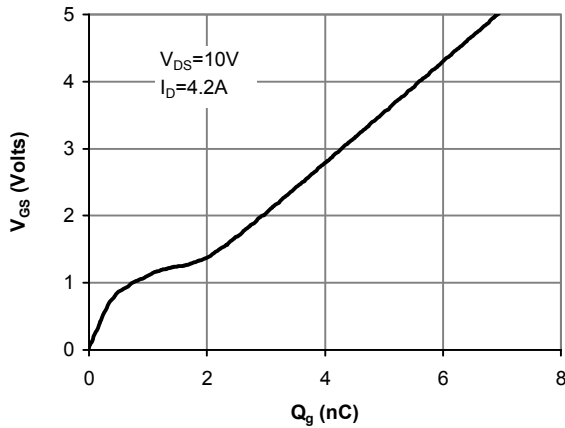

Figure 7: Gate-Charge Characteristics

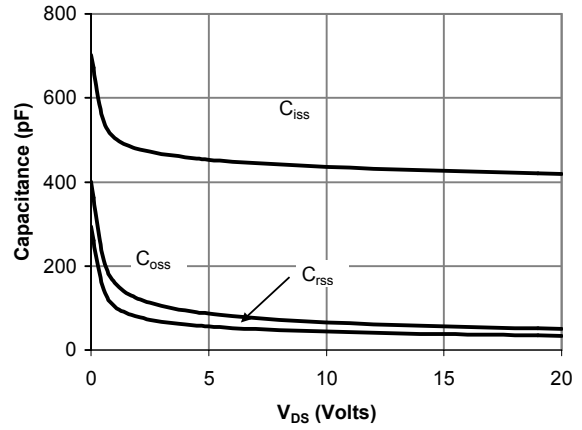

Figure 8: Capacitance Characteristics

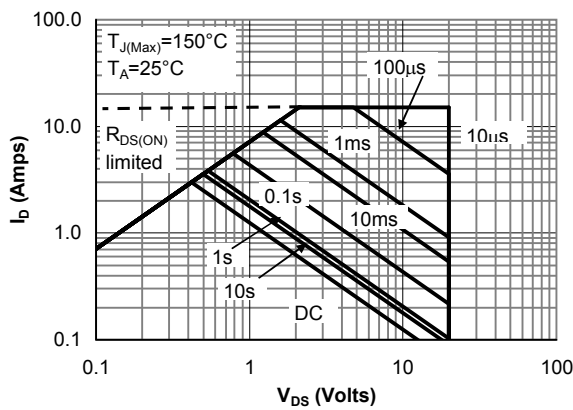

Figure 9: Maximum Forward Biased Safe Operating Area (Note E)

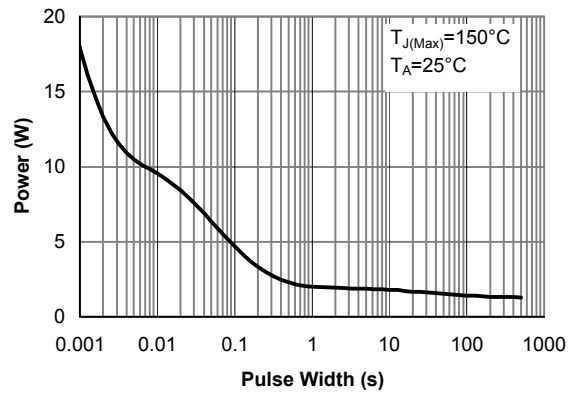

Figure 10: Single Pulse Power Rating Junction-to-Ambient (Note E)

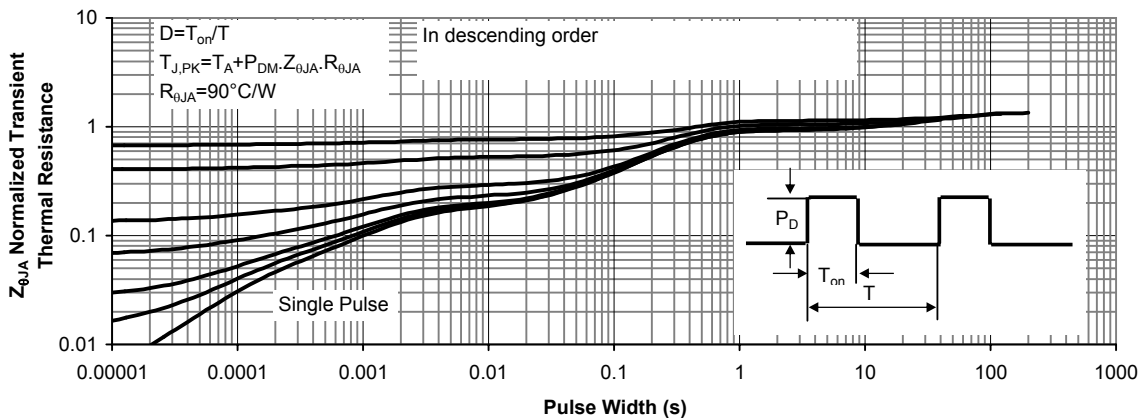
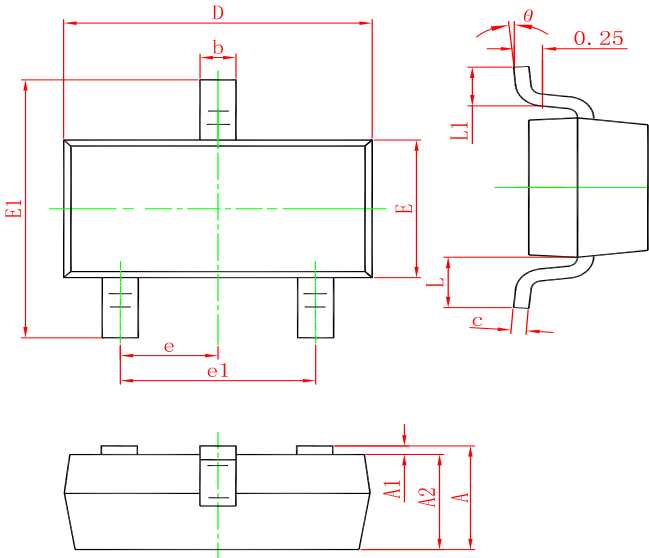

Figure 11: Normalized Maximum Transient Thermal Impedance

SOT-23 PACKAGE OUTLINE DIMENSIONS



Symbol	Dimensions In Millimeters		Dimensions In Inches	
	Min.	Max.	Min.	Max.
A	0.900	1.150	0.035	0.045
A1	0.000	0.100	0.000	0.004
A2	0.900	1.050	0.035	0.041
b	0.300	0.500	0.012	0.020
c	0.080	0.150	0.003	0.006
D	2.800	3.000	0.110	0.118
E	1.200	1.400	0.047	0.055
E1	2.250	2.550	0.089	0.100
e	0.950 TYP.		0.037 TYP.	
e1	1.800	2.000	0.071	0.079
L	0.550 REF.		0.022 REF.	
L1	0.300	0.500	0.012	0.020
θ	0°	8°	0°	8°

Marking

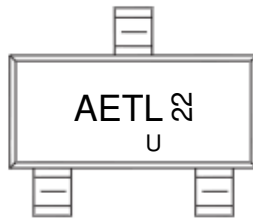

Ordering information

Order code	Package	Baseqty	Deliverymode
UMW AO3414A	SOT-23	3000	Tape and reel