

# SAC-4P-M12MS/5,0-500 FB - Sensor/actuator cable



1420942

<https://www.phoenixcontact.com/us/products/1420942>

Please be informed that the data shown in this PDF document is generated from our online catalog. Please find the complete data in the user documentation. Our general terms of use for downloads are valid.



Sensor/actuator cable, 4-position, Plug straight M12, coding: A, on free cable end, cable length: 5 m, with high-grade steel knurl

## Your advantages

- Easy and safe: 100% electrically tested plug-in components
- Contamination can be detected quickly – thanks to the light color

## Commercial data

Item number	1420942
Packing unit	1 pc
Minimum order quantity	1 pc
Note	Made to order (non-returnable)
Sales key	BF03
Product key	BF1CCA
GTIN	4055626249902
Weight per piece (including packing)	198.79 g
Weight per piece (excluding packing)	189.75 g
Customs tariff number	85444290
Country of origin	PL

# SAC-4P-M12MS/5,0-500 FB - Sensor/actuator cable



1420942

<https://www.phoenixcontact.com/us/products/1420942>

## Technical data

### Product properties

Product type	Sensor/actuator cable
Number of positions	4
Application	Food processing industry
No. of cable outlets	1
Shielded	no
Coding	A

### Insulation characteristics

Overvoltage category	II
Degree of pollution	3

### Material specifications

Material of grip body	PP
Contact material	CuSn
Contact surface material	Ni/Au
Contact carrier material	PP
Material for screw connection	Stainless steel

### Electrical properties

Contact resistance	$\leq 5 \text{ m}\Omega$
Insulation resistance	$\geq 100 \text{ M}\Omega$
Nominal voltage $U_N$	250 V AC
	250 V DC
Nominal current $I_N$	4 A
Protective circuit	unwired

### Mechanical properties

#### Mechanical data

Insertion/withdrawal cycles	$\geq 100$
-----------------------------	------------

### Signaling

Status display	No
Status display present	No

### Connection data

#### Conductor connection

Tightening torque	0.4 Nm (M12 connector)
-------------------	------------------------

### Connector

#### Connection 1

# SAC-4P-M12MS/5,0-500 FB - Sensor/actuator cable



1420942

<https://www.phoenixcontact.com/us/products/1420942>

Type	Plug straight M12
Number of positions	4
Coding type	A
Number of positions	4

## Connection 2

Type	free cable end
------	----------------

## Cable/line

Cable length	5 m
--------------	-----

## PVC gray [500]

Dimensional drawing	
Cable weight	40 kg/km
UL AWM Style	2464 / 1729 (80°C/300 V)
Number of positions	4
Shielded	no
Cable type	PVC gray [500]
Conductor structure signal line	19x 0.15 mm
AWG signal line	22
Conductor cross section	4x 0.34 mm <sup>2</sup> (Signal line)
Wire diameter incl. insulation	1.26 mm ±0.05 mm
External cable diameter	4.7 mm ±0.15 mm
Outer sheath, material	PVC
External sheath, color	gray RAL 7001
Conductor material	Bare Cu litz wires
Material wire insulation	PVC
Single wire, color	brown, white, blue, black
Thickness, insulation	≥ 0.23 mm (Core insulation)
Thickness, outer sheath	≥ 0.76 mm
Overall twist	4 wires, twisted
Max. conductor resistance	max. 57 Ω/km (at 20 °C)
Insulation resistance	≥ 200 MΩ*km (at 20 °C)
Nominal voltage, cable	≤ 300 V
Test voltage	≥ 3000 V
Minimum bending radius, fixed installation	5 x D
Minimum bending radius, flexible installation	10 x D
Ambient temperature (operation)	-40 °C ... 80 °C (cable, fixed installation)

# SAC-4P-M12MS/5,0-500 FB - Sensor/actuator cable



1420942

<https://www.phoenixcontact.com/us/products/1420942>

-25 °C ... 80 °C (Cable, flexible installation)
---

## Environmental and real-life conditions

### Ambient conditions

Degree of protection	IP65
	IP67
	IP68
	IP69K
Ambient temperature (operation)	-25 °C ... 90 °C (Plug / socket)

## Standards and regulations

### M12

Standard designation	M12 connector
Standards/specifications	IEC 61076-2-101

# SAC-4P-M12MS/5,0-500 FB - Sensor/actuator cable

1420942

<https://www.phoenixcontact.com/us/products/1420942>

## Drawings

Dimensional drawing

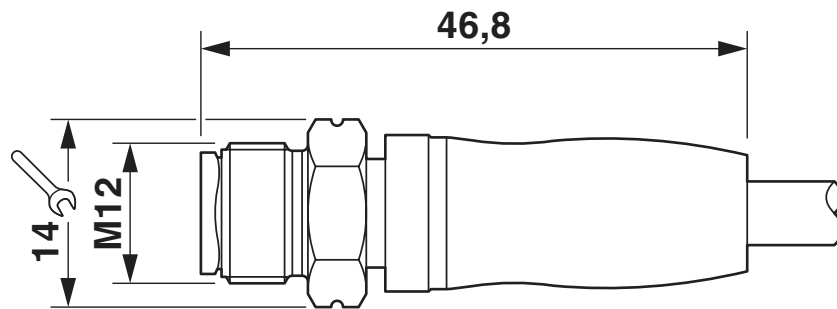

Plug, M12 x 1, straight

Schematic diagram

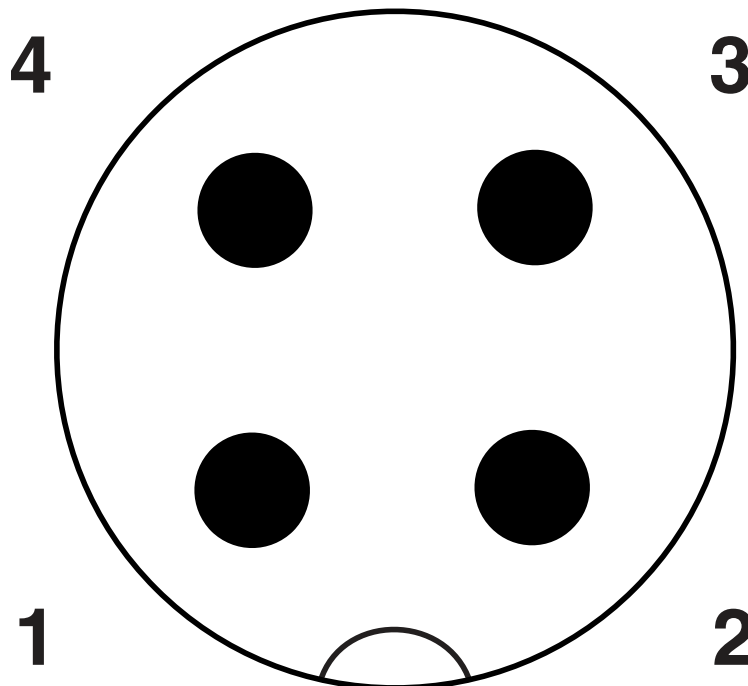

Pin assignment M12 plug, 4-pos., A-coded, view plug side

# SAC-4P-M12MS/5,0-500 FB - Sensor/actuator cable



1420942

<https://www.phoenixcontact.com/us/products/1420942>

Circuit diagram

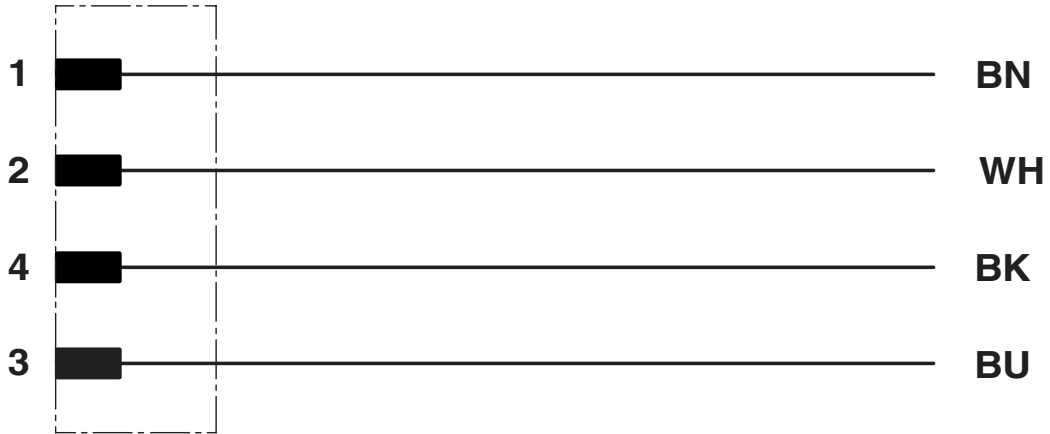

# SAC-4P-M12MS/5,0-500 FB - Sensor/actuator cable





1420942

<https://www.phoenixcontact.com/us/products/1420942>

## Approvals

To download certificates, visit the product detail page: <https://www.phoenixcontact.com/us/products/1420942>

 <b>UL Listed</b> Approval ID: FILE E 221474	Nominal voltage $U_N$	Nominal current $I_N$	Cross section AWG	Cross section $\text{mm}^2$
	250 V	4 A	-	-

 <b>cUL Listed</b> Approval ID: FILE E 221474	Nominal voltage $U_N$	Nominal current $I_N$	Cross section AWG	Cross section $\text{mm}^2$
	250 V	4 A	-	-

 <b>EAC-RoHS</b> Approval ID: RU D-DE.HB35.B.00385
---

<b>cULus Listed</b>
---------------------

# SAC-4P-M12MS/5,0-500 FB - Sensor/actuator cable



1420942

<https://www.phoenixcontact.com/us/products/1420942>

## Classifications

### ECLASS

ECLASS-11.0	27060311
ECLASS-12.0	27060311
ECLASS-13.0	27060311

### ETIM

ETIM 8.0	EC001855
----------	----------

### UNSPSC

UNSPSC 21.0	26121600
-------------	----------



# SAC-4P-M12MS/5,0-500 FB - Sensor/actuator cable



1420942

<https://www.phoenixcontact.com/us/products/1420942>

## Environmental product compliance

REACH SVHC	Dechlorane Plus
China RoHS	Environmentally friendly use period: unlimited = EFUP-e
	No hazardous substances above threshold values

# SAC-4P-M12MS/5,0-500 FB - Sensor/actuator cable



1420942

<https://www.phoenixcontact.com/us/products/1420942>

## Accessories

### TSD 04 SAC - Torque screwdriver

1208429

<https://www.phoenixcontact.com/us/products/1208429>



Torque screwdriver, with preset torque of 0.4 Nm and 4 mm hexagonal drive for M12 connectors

---

### TSD-M 1,2NM - Torque screwdriver

1212224

<https://www.phoenixcontact.com/us/products/1212224>



Torque screw driver, accuracy as per EN ISO 6789 standard, adjustable from 0.3 - 1.2 Nm

# SAC-4P-M12MS/5,0-500 FB - Sensor/actuator cable



1420942

<https://www.phoenixcontact.com/us/products/1420942>

## TSD-M SAC-BIT ADAPTER - Adapter insert

1212600

<https://www.phoenixcontact.com/us/products/1212600>



Adapter bit for TSD-M...torque tools, E6.3-1/4" drive with 4 mm hexagon to accommodate SAC bits

---

## SAC BIT M12-W14 - Tool

1212513

<https://www.phoenixcontact.com/us/products/1212513>



Nut for assembling sensor/actuator cables with M12 connector and M12 connectors for assembly, with a hexagonal knurl wrench size of 14 mm, with 4 mm hexagonal drive

# SAC-4P-M12MS/5,0-500 FB - Sensor/actuator cable



1420942

<https://www.phoenixcontact.com/us/products/1420942>

## CUTFOX-S VDE - Diagonal cutter

1212207

<https://www.phoenixcontact.com/us/products/1212207>



Diagonal cutter for hard (piano wire) and soft wires, VDE 1000 V AC/1500 V DC tested

---

## WIREFOX SAC - Stripping tool

1212623

<https://www.phoenixcontact.com/us/products/1212623>



Stripping pliers, for halogen-free sensor/actuator cables (SAC cables), with PUR and PVC insulation, from Ø of 4.4 to 7 mm, any stripping length

# SAC-4P-M12MS/5,0-500 FB - Sensor/actuator cable



1420942

<https://www.phoenixcontact.com/us/products/1420942>

## WIREFOX 10 - Stripping tool

1212150

<https://www.phoenixcontact.com/us/products/1212150>



Stripping tool, for cables and conductors from 0.02 - 10 mm<sup>2</sup>, self-adjusting, stripping length of up to 18 mm, cutting capacity of up to 10 mm<sup>2</sup> stranded/1.5 mm<sup>2</sup> solid, replaceable stripping blade

---

Phoenix Contact 2023 © - all rights reserved

<https://www.phoenixcontact.com>

Phoenix Contact USA  
586 Fulling Mill Road  
Middletown, PA 17057, United States  
(+717) 944-1300  
[info@phoenixcon.com](mailto:info@phoenixcon.com)