

Tous droits strictement réservés. Reproduction ou communication a des tiers interdite sous quelque forme que ce soit sans autorisation écrite du propriétaire. Propriété de c FCI. Droits de reproduction FCI.

FCI

All rights strictly reserved. Reproduction or issue to third parties in any form whatever is not permitted without written authority from the proprietor. Property of FCI. Copyright FCI.

PRODUCT NUMBER
51793-001--
NOTE: ②

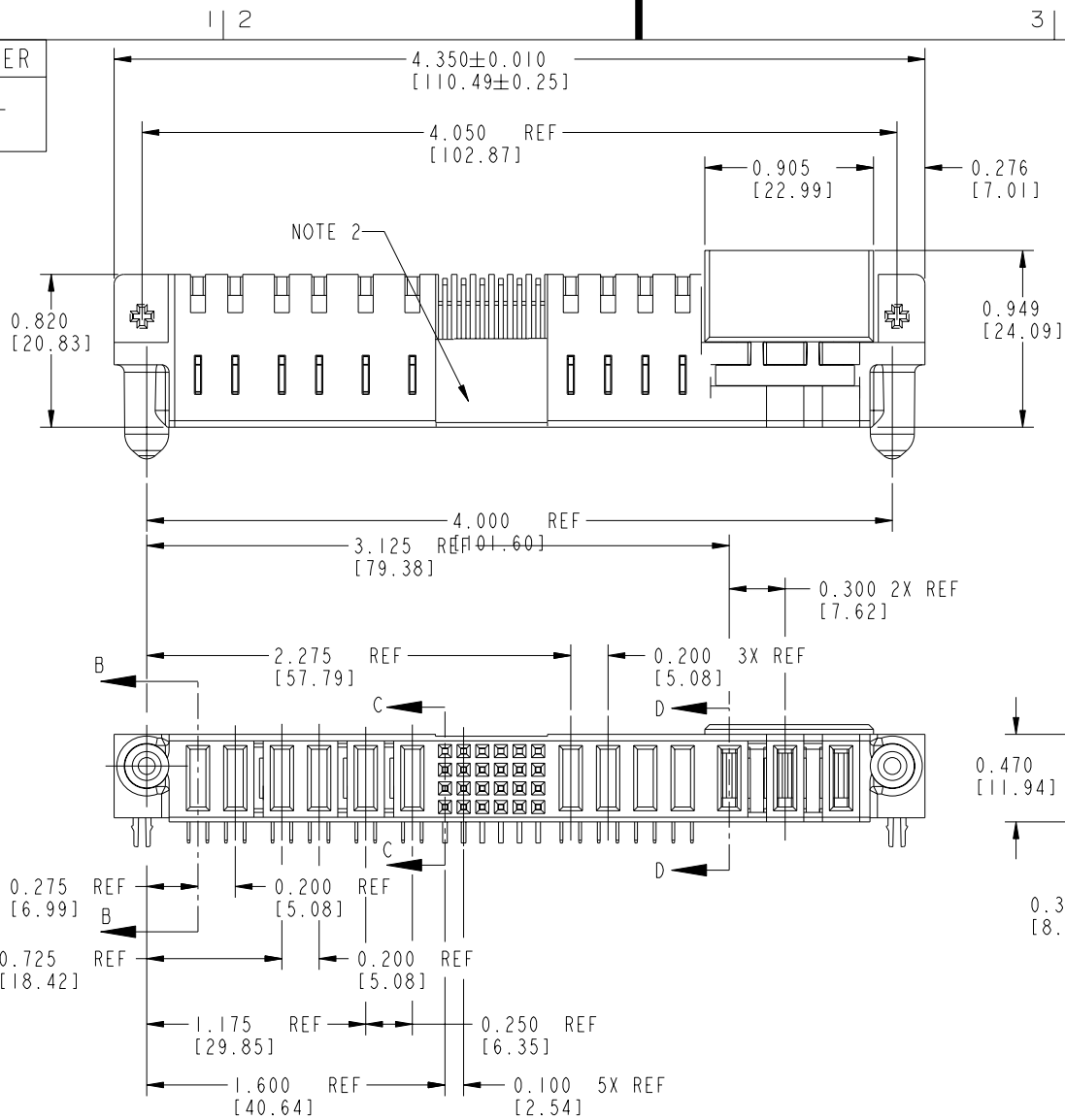

CONFIDENTIAL

mat'l code				tolerances unless otherwise specified				CUSTOMER		FCI www.fciconnect.com	
ltr	ecn no.	dr	date	linear	.xx±.01/0.xx±0.3		COPY		title		
A	V10162	CGD	01-18-01		.xxx±.005/0.xx±0.13		projection		3ACP + 4P + 24S + 6P		
B	V04-0788	TAB	08/03/04		.xxx±.0005/0.xxx±.013		INCH/MM		R/A SOLDER RECEPT SPECIAL CABLE		
C	DG05-0301	CS	08/29/05	angles	0°±2°		scale		product family	PwrBlade	
				dr	C. DAILY	07-26-00	1:1		size	code	
				engr	J. BROWN	07-18-00			dwg no	213	
				chr	J. BROWN	07-26-00			A	51793	
				appd	J. BROWN	07-26-00				sheet	
sheet index	revision sheet	C 1	C 2	C 3	C 4					1 of 4	

Pro/E

cage code 22526

PDM: Rev:C

STATUS: **Released**

Printed: Dec 20, 2010

Tous droits strictement réservés. Reproduction ou communication o des tiers interdite sous quelque forme que ce soit sans autorisation écrite du propriétaire. Propriété de c FCI. Droits de reproduction FCI.

FCI

All rights strictly reserved. Reproduction or issue to third parties in any form, whenever is not permitted without written authority from the proprietor. Property of FCI. Copyright FCI.

PRODUCT NUMBER
51793-001--
NOTE: ②

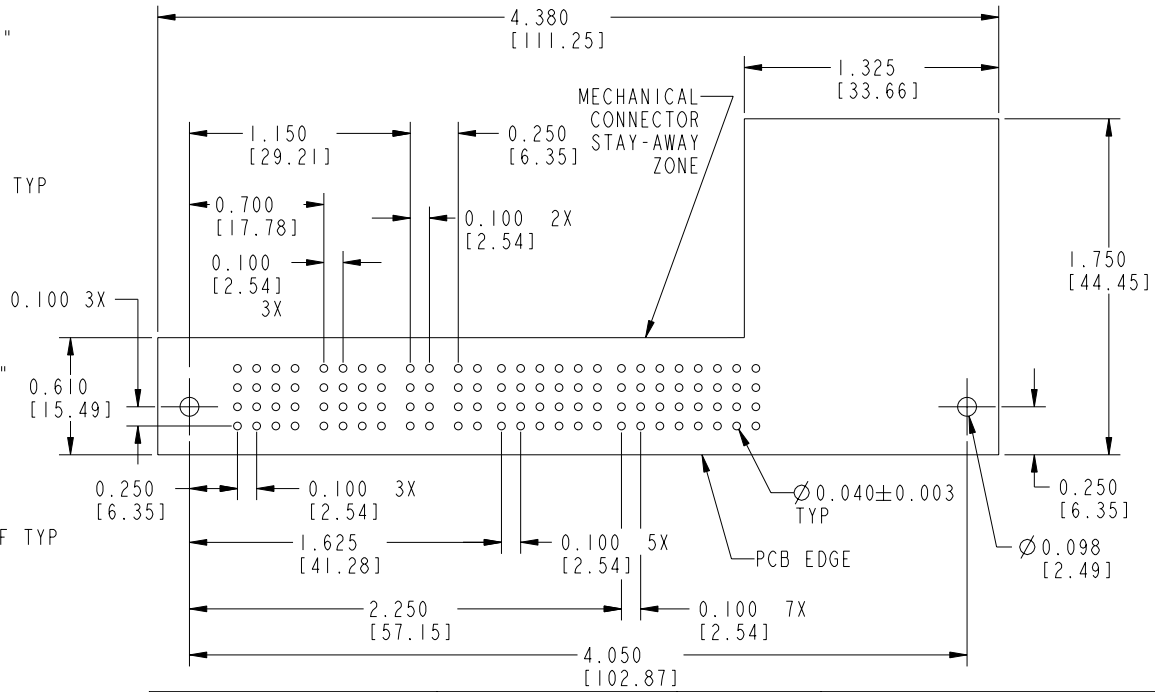
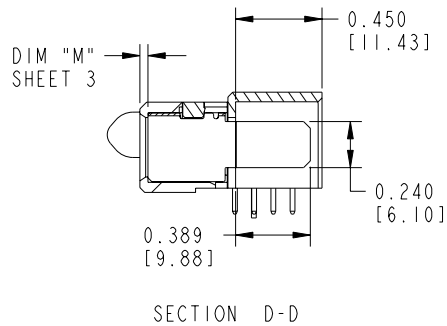
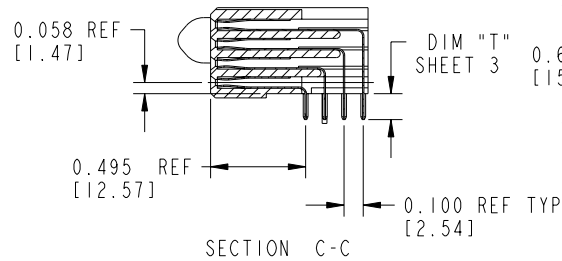
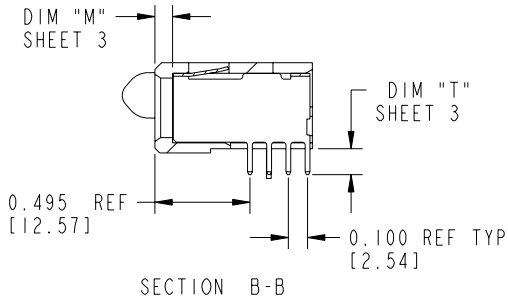

mat'l code				tolerances unless otherwise specified		CUSTOMER		FCI www.fciconnect.com	
ltr	ecn no.	dr	date	linear	.xx±.01/0.xx±0.3	COPY		title	
C					.xxx±.005/0.xx±0.13	projection		3ACP + 4P + 24S + 6P	
				angles	.xxx±.0005/0.xxx±.013	INCH/MM		R/A SOLDER RECEPT SPECIAL CABLE	
				dr	0°±2°	scale		product family	
				engr	C. DAILY 07-26-00	1:1		PwrBlade	
				chr	J. BROWN 07-18-00			code	
				appd	J. BROWN 07-26-00			213	
sheet index		revision sheet						sheet	
								2 of 4	

Pro/E

cage code 22526

PDM: Rev:C

STATUS: Released

Printed: Dec 20, 2010

Tous droits strictement réservés. Reproduction ou communication a des tiers interdite sous quelque forme que ce soit sans autorisation écrite du propriétaire. Propriété de c FCI. Droits de reproduction FCI.



A
FCI

All rights strictly reserved. Reproduction or issue to third parties in any form whatever is not permitted without written authority from the proprietor. Property of FCI. Copyright FCI.

PRODUCT NUMBER
51793-001-- NOTE: ②

ITEM NO.	QTY	DIM "M" MATING LENGTH +/- .010		DIM "T" TAIL LENGTH +/- .010		CONTACT TYPE	PLATING FOR MATING	PLATING FOR TAIL
E	6	N/A	[N/A]	0.135	[3.43]	SIGNAL	30 u'' [.76um]Au	Sn
F	6	N/A	[N/A]	0.135	[3.43]	SIGNAL	30 u'' [.76um]Au	Sn
G	6	N/A	[N/A]	0.135	[3.43]	SIGNAL	30 u'' [.76um]Au	Sn
H	6	N/A	[N/A]	0.135	[3.43]	SIGNAL	30 u'' [.76um]Au	Sn
PC	10	0.092	[2.34]	0.135	[3.43]	POWER	30 u'' [.76um]Au	Sn
PG	1	0.042	[1.07]	N/A	[N/A]	POWER	30 u'' [.76um]Au	Sn
PH	2	0.092	[2.34]	N/A	[N/A]	POWER	30 u'' [.76um]Au	Sn
HA	2	N/A	[N/A]	N/A	[N/A]	HOLD-DOWN	N/A [N/A]	Ni

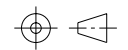
PRODUCT No.	ROWS	SIGNAL																EI				
		E2	P13	P12	P11	P10	P9	P8	6	5	4	3	2	1	P7	P6	P5		P4	P3	P2	P1
51793-001-- NOTE: ②	D		PC	PC	PC	PC	PC	PC	H	H	H	H	H	H	PC	PC	PC	PC	PG	PH	PH	
	C								G	G	G	G	G	G								
	B								F	F	F	F	F	F								
A	A	HA							E	E	E	E	E	E								HA

mat'l code				tolerances unless otherwise specified				CUSTOMER		A FCI		www.fciconnect.com		
ltr	ecn no.	dr	date	linear	.xx±.01/0.xx±0.3				COPY		 title 3ACP + 4P + 24S + 6P R/A SOLDER RECEPT SPECIAL CABLE		product family PwrBlade code 213 size dwg no 51793 sheet 3 of 4	
C					.xxx±.005/0.xx±0.13				projection					
					.xxx±.0005/0.xxx±.013				 INCH/MM					
				angles	0°±2°				scale 1:1		A			
				dr	C. DAILY	07-26-00								
				enrg	J. BROWN	07-18-00								
				chr	J. BROWN	07-26-00								
				appd	J. BROWN	07-26-00								
sheet index	revision sheet													

cage code 22526

Pro/E

PDM: Rev:C

STATUS: **Released**

Printed: Dec 20, 2010

Tous droits strictement reserves. Reproduction ou communication a des tiers interdite sous quelque forme que ce soit sans autorisation écrite du propriétaire. Propriete de c FCI. Droits de reproduction FCI.

A FCI

All rights strictly reserved. Reproduction or issue to third parties in any form whatever is not permitted without written authority from the proprietor. Property of FCI. Copyright FCI.

B

PRODUCT NUMBER
51793-001--
NOTE: ②

CONNECTOR NOTES:

- ① HOUSING MATERIAL: UL 94 V-0 GLASS FILLED HIGH TEMP THERMOPLASTIC
POWER CONTACT MATERIAL: COPPER ALLOY
SIGNAL CONTACT MATERIAL: COPPER ALLOY
- ② PLATING:
51793-001 Singal Pin: 30u"/0.76um Au OVER 50u"/1.27um Ni ON THE CONTACT AREA,
AND 100u"/2.54um SnPb PLATING OVER 50u"/1.27um Ni ON THE TERMINATION SECTION.
Power Pin: 30u"/0.76um Au OVER 50u"/1.27um Ni ON THE CONTACT AREA,
AND 100u"/2.54um SnPb PLATING OVER 50u"/1.27um Ni ON THE TERMINATION SECTION.
51793-001LF Singal Pin: 30u"/0.76um Au OVER 50u"/1.27um Ni ON THE CONTACT AREA,
AND 78u"/2.00um Sn PLATING OVER 50u"/1.27um Ni ON THE TERMINATION SECTION.
Power Pin: 30u"/0.76um Au OVER 50u"/1.27um Ni ON THE CONTACT AREA,
AND 78u"/2.00um Sn PLATING OVER 50u"/1.27um Ni ON THE TERMINATION SECTION.

PART NUMBER 51793-001LF MEETS EUROPEAN UNION DIRECTIVE AND OTHER COUNTRY REGULATIONS AS DESCRIBED IN GS-22-008.

THE HOUSING WILL WITHSTAND EXPOSURE TO 260° PEAK TEMPERATURE FOR 10 SECONDS IN A WAVE SOLDER APPLICATION WITH A CIRCUIT BOARD.
AND SnPb ON PCB INTERFACE}

- 3. "MANUFACTURER" NAME, P/N, AND DATE CODE TO APPEAR ON THIS SURFACE
- 4. PRODUCT SPECIFICATION GS-12-149

PCB NOTES:

- 5. ALL DIMENSIONS ARE BASIC UNLESS OTHERWISE SPECIFIED.
- 6. ALL THROUGH HOLES ARE LOCATED WITH A TRUE POSITION OF 0.004 [0.10]
- 7. ALL HOLE DIAMETERS ARE FINISHED HOLE SIZE
- 8. Ø0.098[2.49] THROUGH HOLES ARE UNPLATED.
- 9. Ø0.0453±0.0010 [1.151±0.025] DRILLED HOLES PLATED WITH 0.0003 [0.008] MIN SnPb OVER 0.001 [0.03] TO 0.003 [0.08] Cu PLATING TO ACHIEVE A Ø0.040±0.003 [1.02±0.07] HOLE.

CONFIDENTIAL

mat'l code				tolerances unless otherwise specified		CUSTOMER	A FCI www.fciconnect.com	
ltr	ecn no.	dr	date	linear	.XX±.01/0.X±0.3	projection	COPY	title 3ACP + 4P + 24S + 6P R/A SOLDER RECEPT SPECIAL CABLE
C					.XXX±.005/0.XX±0.13			
				angles	0°±2°	size A	dwg no 51793	sheet 4 of 4
				dr	C. DAILY 07-26-00			
				engr	J. BROWN 07-18-00	4 of 4		
				chr	J. BROWN 07-26-00			
				appd	J. BROWN 07-26-00			
sheet index	revision sheet							

B

1 | 2

3 |

4

1 | 2

Pro/E

3 |

cage code 22526

4