

MMBT5401-HF (PNP)

RoHS Device

Halogen Free

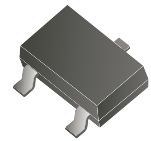

Features

- Epoxy meets UL-94 V-0 flammability rating.
- Moisture sensitivity Level 1.

Mechanical data

- Case: SOT-23, molded plastic.
- Terminals: Tin plated leads, solderable per J-STD-002 and JESD22-B102.

Circuit Diagram

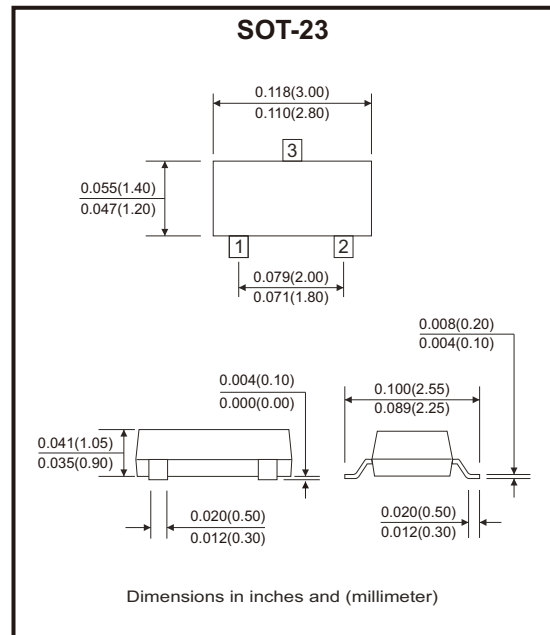
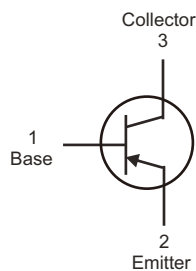

Maximum Ratings (at $T_A=25^\circ\text{C}$ unless otherwise noted)

Parameter	Conditions	Symbol	Value	Unit
Collector-base voltage	$I_C = -100\mu\text{A}$, $I_E = 0$	V_{CB0}	-180	V
Collector-emitter voltage	$I_C = -1\text{mA}$, $I_B = 0$	V_{CE0}	-160	V
Emitter-base voltage	$I_E = -10\mu\text{A}$, $I_C = 0$	V_{EB0}	-6	V
Collector current		I_C	-600	mA
Collector power dissipation		P_C	300	mW
Operation junction temperature		T_J	150	$^\circ\text{C}$
Storage temperature range		T_{STG}	-55 to +150	$^\circ\text{C}$
Thermal resistance from junction to ambient		$R_{\theta JA}$	417	$^\circ\text{C/W}$

Electrical Characteristics (at $T_A=25^\circ\text{C}$ unless otherwise noted)

Parameter	Symbol	Conditions	Min.	Typ.	Max.	Unit
Collector-base voltage	V_{CBO}	$I_C = -100\mu\text{Adc}$, $I_E = 0$	-180			V
Collector-emitter voltage	V_{CEO}	$I_C = -1\text{mAdc}$, $I_B = 0$	-160			V
Emitter-base voltage	V_{EBO}	$I_E = -10\mu\text{Adc}$, $I_C = 0$	-6			V
Collector-base cut-off current	I_{CBO}	$V_{CB} = -120\text{Vdc}$			-50	nA
Emitter-emitter cut-off current	I_{EBO}	$V_{EB} = -4\text{Vdc}$			-50	nA
DC current gain	$h_{FE(1)}$	$V_{CE} = -5\text{Vdc}$, $I_C = -1\text{mA}$	80			
	$h_{FE(2)}$	$V_{CE} = -5\text{Vdc}$, $I_C = -10\text{mA}$	100		300	
	$h_{FE(3)}$	$V_{CE} = -5\text{Vdc}$, $I_C = -50\text{mA}$	50			
Collector-emitter saturation voltage	$V_{CE(sat)}$	$I_C = -10\text{mA}$, $I_B = -1\text{mA}$			-0.2	V
		$I_C = -50\text{mA}$, $I_B = -5\text{mA}$			-0.5	V
Base-emitter saturation voltage	$V_{BE(sat)}$	$I_C = -10\text{mA}$, $I_B = -1\text{mA}$			-1.0	V
		$I_C = -50\text{mA}$, $I_B = -5\text{mA}$			-1.0	V
Transition frequency	f_r	$V_{CE} = -5\text{Vdc}$, $I_C = -10\text{mAdc}$, $f = 30\text{MHz}$	100		300	MHz

Rating and Characteristic Curves (MMBT5401-HF)

Fig.1 - Static Characteristic

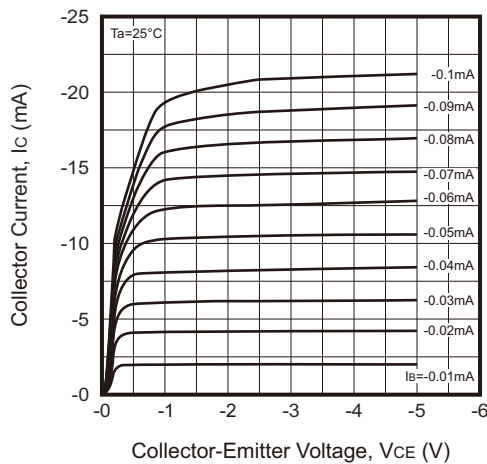
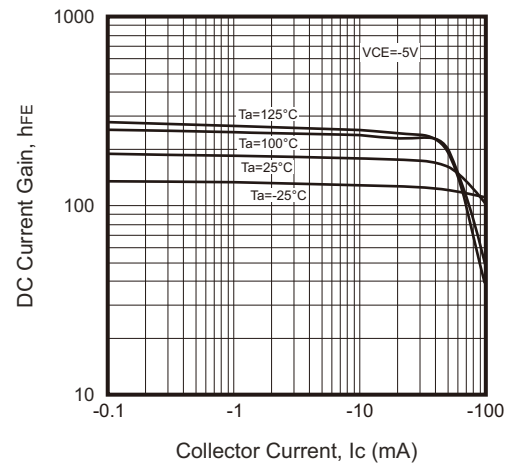

Fig.2 - DC Current Gain



Rating and Characteristic Curves (MMBT5401-HF)

Fig.3 - Collector-Emitter Saturation Voltage

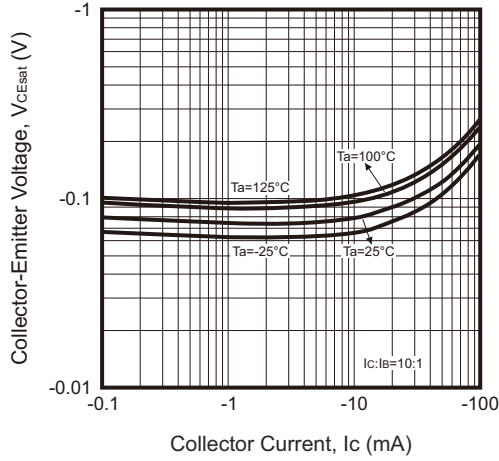

Fig.4 - Base-Emitter Saturation Voltage

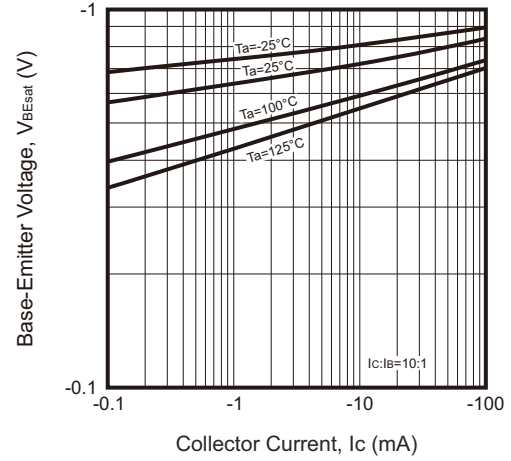

Fig.5 - Base-Emitter on Voltage

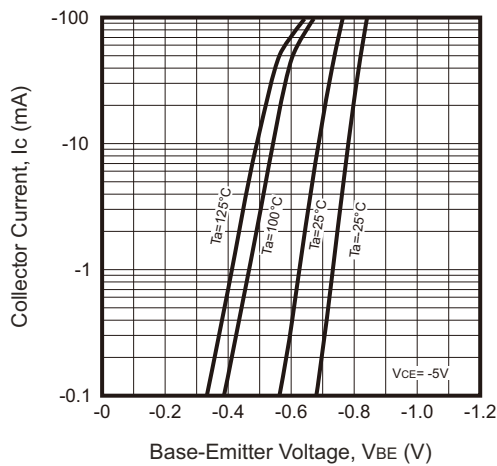

Fig.6 - $C_{ob}/C_{ib} \text{ --- } V_{CB}/V_{EB}$

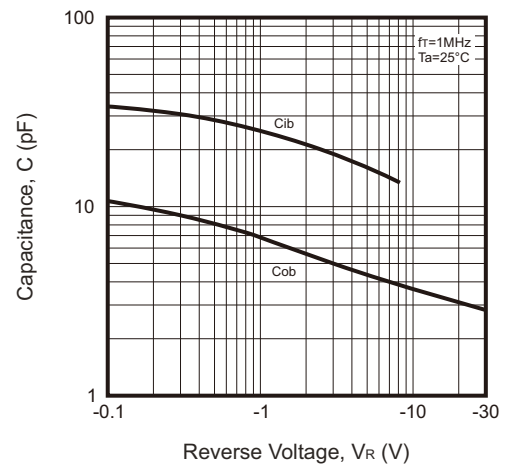
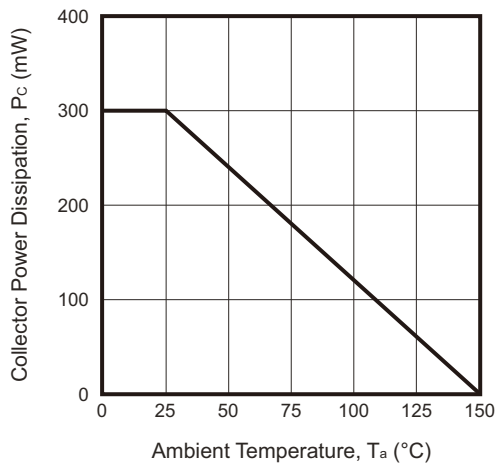
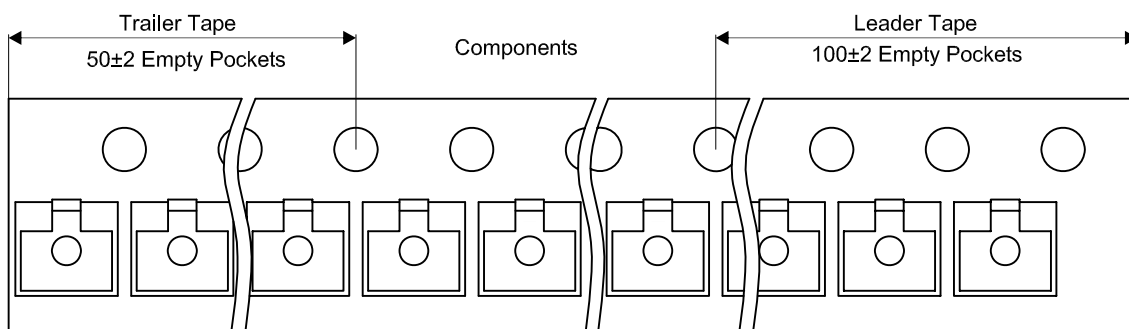
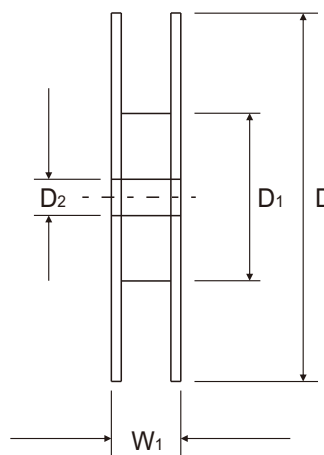
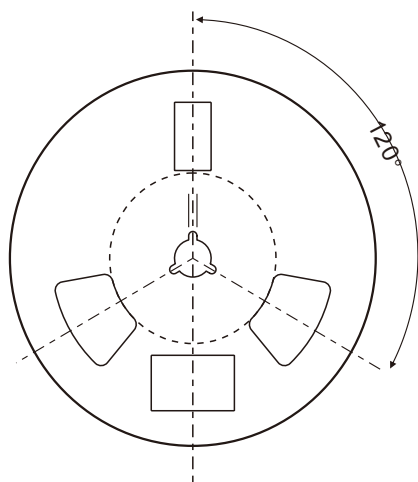
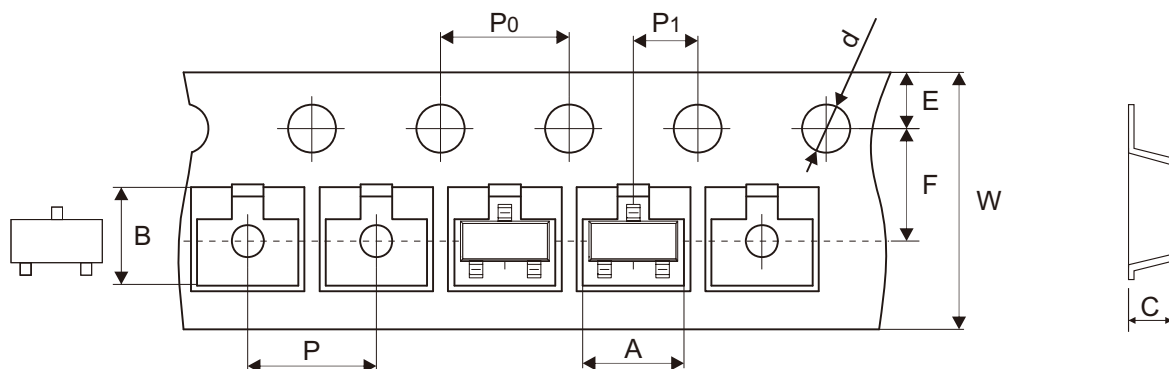

Fig.7 - Collector Power Derating Curve



Reel Taping Specification



SOT-23	SYMBOL	A	B	C	d	D	D ₁	D ₂
	(mm)	3.15 ± 0.10	2.77 ± 0.10	1.22 ± 0.10	1.50 + 0.10 - 0.00	178.00 ± 1.00	54.60 ± 1.00	13.30 ± 1.00
	(inch)	0.124 ± 0.004	0.109 ± 0.004	0.048 ± 0.004	0.059 + 0.004 - 0.000	7.008 ± 0.039	2.150 ± 0.039	0.524 ± 0.039

SOT-23	SYMBOL	E	F	P	P ₀	P ₁	W	W ₁
	(mm)	1.75 ± 0.10	3.50 ± 0.05	4.00 ± 0.10	4.00 ± 0.10	2.00 ± 0.05	8.00 + 0.30 - 0.10	11.10 ± 0.20
	(inch)	0.069 ± 0.004	0.138 ± 0.002	0.157 ± 0.004	0.157 ± 0.004	0.079 ± 0.002	0.315 + 0.012 - 0.004	0.437 ± 0.008

Marking Code

Part Number	Marking Code
MMBT5401-HF	2L

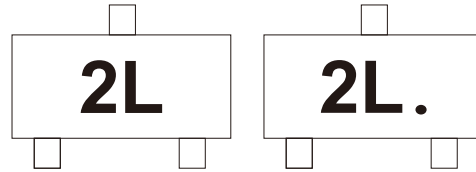

Solid dot = Control code

Suggested P.C.B. PAD Layout

SIZE	SOT-23	
	(mm)	(inch)
A	0.90	0.035
B	0.80	0.031
C	0.95	0.037
D	2.00	0.079
E	2.90	0.114

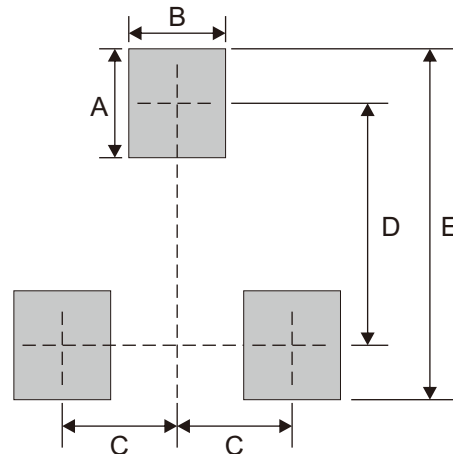

Note: 1. The pad layout is for reference purposes only.

Standard Packaging

Case Type	REEL PACK	
	REEL (pcs)	Reel Size (inch)
SOT-23	3,000	7