

1438299-4 ✓ ACTIVE

AMP | [Get .64 Connector System](#)

TE Internal #: 1438299-4

Automotive Terminals, Tab, Mating Tab Width 1 mm [.039 in], Tab Thickness .64 mm [.025 in], 20 – 18 AWG Wire Size, Get .64 Connector System

[View on TE.com >](#)



Terminals & Splices > Automotive Terminals > GET .64 CONNECTOR SYSTEM, RECEPT AND TAB



Terminal Type: **Tab**

Mating Tab Width: **1 mm [.039 in]**

Mating Tab Thickness: **.64 mm [.025 in]**

Terminal Transmits: **0 – 24 A (Low Power)**

Wire Size: **20 – 18 AWG**

[All GET .64 Connector System, Recept and Tab \(29\)](#)

Features

Product Type Features

Sealable	No
Primary Locking Feature	Clean Body

Contact Features

Contact Size	1mm
Contact Fabrication	Stamped & Formed
Wire Contact Termination Area Plating Material	Gold
Typical Current Rating	11 A
Crimp Type	F-Crimp
Terminal Type	Tab
Mating Tab Width	1 mm [.039 in]
Mating Tab Thickness	.64 mm [.025 in]
Interface Plating	Tin (Sn)

Termination Features

Termination Method to Wire & Cable	Crimp
Product Terminates To	Wire

Dimensions

Compatible Insulation Diameter Range	1.4 – 2.06 mm [.055 – .081 in]
--------------------------------------	--------------------------------



Wire Size	.5 – .75 mm ²
-----------	--------------------------

Wire Size Search	18 AWG, 19 AWG, 20 AWG
------------------	------------------------

Usage Conditions

Insulation Option	Uninsulated
-------------------	-------------

Operating Temperature (Max)	80 °C, 85 °C, 90 °C, 100 °C, 105 °C, 110 °C, 120 °C, 125 °C[176 °F][185 °F][194 °F][212 °F][221 °F][230 °F][248 °F][257 °F]
-----------------------------	---

Operating Temperature Range	-40 – 125 °C[-40 – 257 °F]
-----------------------------	----------------------------

Operation/Application

Compatible With Wire Base Material	Copper
------------------------------------	--------

Industry Standards

Agency/Standard	SAE/USCAR-2, USCAR-21
-----------------	-----------------------

Packaging Features

Packaging Quantity	11000
--------------------	-------

Packaging Method	Reel
------------------	------

Other

Terminal Transmits	0 – 24 A (Low Power)
--------------------	----------------------

Product Compliance

[For compliance documentation, visit the product page on TE.com>](#)

EU RoHS Directive 2011/65/EU	Compliant
------------------------------	-----------

EU ELV Directive 2000/53/EC	Compliant
-----------------------------	-----------

China RoHS 2 Directive MIIT Order No 32, 2016	No Restricted Materials Above Threshold
---	---

EU REACH Regulation (EC) No. 1907/2006	Current ECHA Candidate List: JUNE 2023 (235) Candidate List Declared Against: JUNE 2023 (235) Does not contain REACH SVHC
--	---

Halogen Content	Low Halogen - Br, Cl, F, I < 900 ppm per homogenous material. Also BFR/CFR/PVC Free
-----------------	---

Solder Process Capability	Not applicable for solder process capability
---------------------------	--

Product Compliance Disclaimer

This information is provided based on reasonable inquiry of our suppliers and represents our current actual knowledge based on the information they provided. This information is subject to change. The part numbers that TE has identified as



EU RoHS compliant have a maximum concentration of 0.1% by weight in homogenous materials for lead, hexavalent chromium, mercury, PBB, PBDE, DBP, BBP, DEHP, DIBP, and 0.01% for cadmium, or qualify for an exemption to these limits as defined in the Annexes of Directive 2011/65/EU (RoHS2). Finished electrical and electronic equipment products will be CE marked as required by Directive 2011/65/EU. Components may not be CE marked. Additionally, the part numbers that TE has identified as EU ELV compliant have a maximum concentration of 0.1% by weight in homogenous materials for lead, hexavalent chromium, and mercury, and 0.01% for cadmium, or qualify for an exemption to these limits as defined in the Annexes of Directive 2000/53/EC (ELV). Regarding the REACH Regulation, the information TE provides on SVHC in articles for this part number is based on the latest European Chemicals Agency (ECHA) 'Guidance on requirements for substances in articles' posted at this URL: <https://echa.europa.eu/guidance-documents/guidance-on-reach>

Compatible Parts



TE Part # 2305570-1
Strip Terminal Cutter-Side Feed-No Crimp



TE Part # 1393366-1
V23540X7000Y 21=GET-FEM TERM S



TE Part # 1411367-1
2X8 POS. GET MALE ASSY KEY A



TE Part # 2151539-1
OCEAN-2.0-APPLICATOR-S-070F068SP



TE Part # 2-2151539-1
OCEAN-2.0-APPLICATOR-S-070F068SP



TE Part # 2-2151539-2
OCEAN-2.0-APPLICATOR-S-070F068SP



TE Part # 2151539-2
OCEAN-2.0-APPLICATOR-S-070F068SP



TE Part # 7-2151539-1
OCEAN-2.0-APPLICATOR-S-070F068SP



TE Part # 7-2151539-2
OCEAN-2.0-APPLICATOR-S-070F068SP



TE Part # 7-2151539-7
OCEAN_2.0_SPARE_PART_KIT-070F068SP



TE Part # 6-1393462-5
GET-B HAND CRIMPING PLIERS

Also in the Series | Get .64 Connector System



Automotive Connector Caps & Covers (7)



Automotive Housings(118)



Automotive Terminals(30)



Insertion & Extraction Tools(1)



PCB Headers & Receptacles(1)

Customers Also Bought

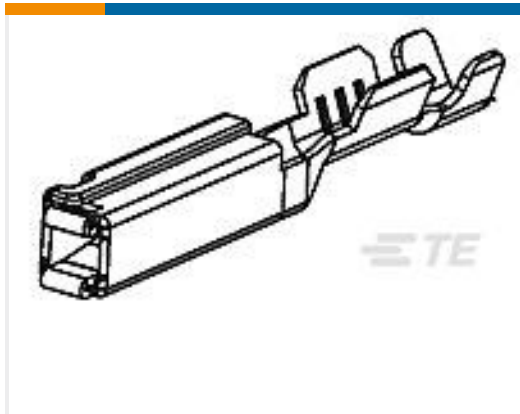

TE Part #1393366-1
V23540X7000Y 21=GET-FEM TERM S



TE Part #7-2151725-7
OCEAN_2.0_SPARE_PART_KIT-053F061O



TE Part #1-2208021-3
22POS,0.64 GENER. Y,REC HSG,ASSY



TE Part #2837923-1
OCEAN-2.0-APPLICATOR-S-048F080F



TE Part #7-2151041-7
OCEAN_2.0_SPARE_PART_KIT-050F120O



TE Part #7-2151965-7
OCEAN_2.0_SPARE_PART_KIT-066F134O



TE Part #7-2266276-7
OC-050F120O-752-CRIMPTOOLINGKIT



TE Part #7-2836607-7
OCEAN_2.0_SPARE_PART_KIT-065F079O

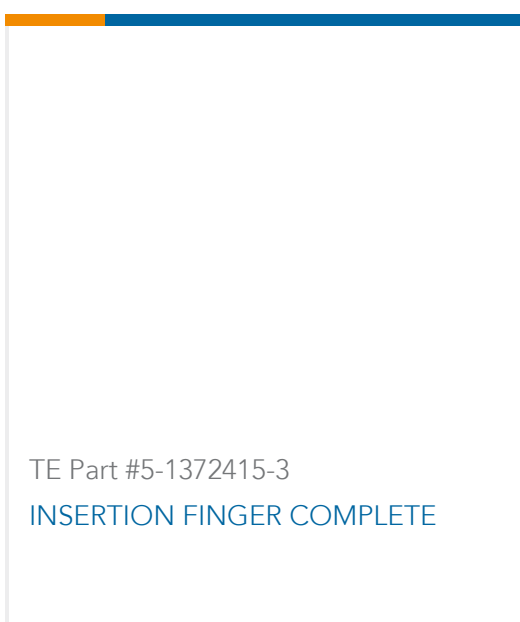

TE Part #5-1372415-3
INSERTION FINGER COMPLETE

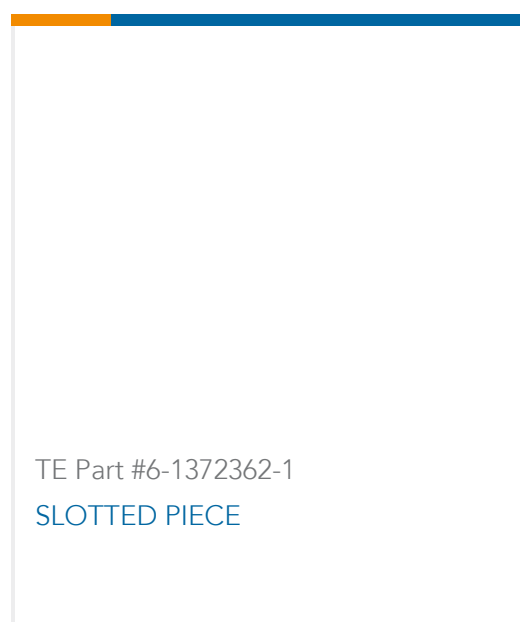

TE Part #6-1372362-1
SLOTTED PIECE

Documents

Product Drawings

[GET MALE TERM, B, SN](#)

English

CAD Files

[Customer View Model](#)

[ENG_CVM_CVM_1438299-4_K.2d_dxf.zip](#)

English

[3D PDF](#)



3D

Customer View Model

[ENG_CVM_CVM_1438299-4_K.3d_igs.zip](#)

English

Customer View Model

[ENG_CVM_CVM_1438299-4_K.3d_stp.zip](#)

English

By downloading the CAD file I accept and agree to the [Terms and Conditions](#) of use.

Datasheets & Catalog Pages

[GET 0.64 Interconnection System](#)

English

Product Specifications

[Application Specification](#)

English

Product Environmental Compliance

[MD_1438299-4_011020182215_dmtec](#)

English

[MD_1438299-4_011020182215_dmtec](#)

English