

Power MOSFET

| PRODUCT SUMMARY | | |
|---------------------------|-----------------|-----|
| V_{DS} (V) | 450 | |
| $R_{DS(on)}$ (Ω) | $V_{GS} = 10$ V | 1.2 |
| Q_g (Max.) (nC) | 45 | |
| Q_{gs} (nC) | 6.6 | |
| Q_{gd} (nC) | 24 | |
| Configuration | Single | |

FEATURES

- Dynamic dV/dt Rating
- Repetitive Avalanche Rated
- Fast Switching
- Ease of Paralleling
- Simple Drive Requirements
- Lead (Pb)-free

RoHS
COMPLIANT

DESCRIPTION

Third generation Power MOSFETs from Vishay provide the designer with the best combination of fast switching, ruggedized device design, low on-resistance and cost-effectiveness.

The TO-220 package is universally preferred for all commercial-industrial applications at power dissipation levels to approximately 50 W. The low thermal resistance and low package cost of the TO-220 contribute to its wide acceptance throughout the industry.

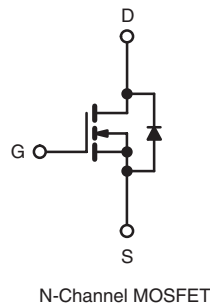
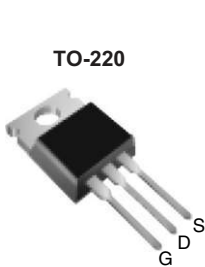



| ORDERING INFORMATION | |
|----------------------|------------|
| Package | TO-220 |
| Lead (Pb)-free | IRF734PbF |
| | SiHF734-E3 |

| ABSOLUTE MAXIMUM RATINGS $T_C = 25$ °C, unless otherwise noted | | | | |
|--|------------------|----------------|------------------|----------|
| PARAMETER | | SYMBOL | LIMIT | UNIT |
| Drain-Source Voltage | | V_{DS} | 450 | V |
| Gate-Source Voltage | | V_{GS} | ± 20 | |
| Continuous Drain Current | V_{GS} at 10 V | I_D | $T_C = 25$ °C | A |
| | | | $T_C = 100$ °C | |
| Pulsed Drain Current ^a | | I_{DM} | 20 | |
| Linear Derating Factor | | | 0.59 | W/°C |
| Single Pulse Avalanche Energy ^b | | E_{AS} | 330 | mJ |
| Repetitive Avalanche Current ^a | | I_{AR} | 4.9 | A |
| Repetitive Avalanche Energy ^a | | E_{AR} | 7.4 | mJ |
| Maximum Power Dissipation | $T_C = 25$ °C | P_D | 74 | W |
| Peak Diode Recovery dV/dt^c | | dV/dt | 4.0 | V/ns |
| Operating Junction and Storage Temperature Range | | T_J, T_{stg} | - 55 to + 150 | °C |
| Soldering Recommendations (Peak Temperature) | for 10 s | | 300 ^d | |
| Mounting Torque | 6-32 or M3 screw | | 10 | lbf · in |
| | | | 1.1 | N · m |

Notes

- Repetitive rating; pulse width limited by maximum junction temperature (see fig. 11).
- $V_{DD} = 50$ V, starting $T_J = 25$ °C, $L = 24$ mH, $R_G = 25$ Ω , $I_{AS} = 4.9$ A (see fig. 12).
- $I_{SD} \leq 4.9$ A, $dI/dt \leq 80$ A/ μ s, $V_{DD} \leq V_{DS}$, $T_J \leq 150$ °C.
- 1.6 mm from case.

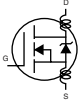
| THERMAL RESISTANCE RATINGS | | | | |
|-------------------------------------|------------|------|------|------|
| PARAMETER | SYMBOL | TYP. | MAX. | UNIT |
| Maximum Junction-to-Ambient | R_{thJA} | - | 62 | °C/W |
| Case-to-Sink, Flat, Greased Surface | R_{thCS} | 0.50 | - | |
| Maximum Junction-to-Case (Drain) | R_{thJC} | - | 1.7 | |

| SPECIFICATIONS $T_J = 25\text{ }^\circ\text{C}$, unless otherwise noted | | | | | | |
|--|---------------------|---|------|------|-----------|---------------|
| PARAMETER | SYMBOL | TEST CONDITIONS | MIN. | TYP. | MAX. | UNIT |
| Static | | | | | | |
| Drain-Source Breakdown Voltage | V_{DS} | $V_{GS} = 0\text{ V}, I_D = 250\text{ }\mu\text{A}$ | 450 | - | - | V |
| V_{DS} Temperature Coefficient | $\Delta V_{DS}/T_J$ | Reference to $25\text{ }^\circ\text{C}$, $I_D = 1\text{ mA}$ | - | 0.63 | - | V/°C |
| Gate-Source Threshold Voltage | $V_{GS(th)}$ | $V_{DS} = V_{GS}, I_D = 250\text{ }\mu\text{A}$ | 2.0 | - | 4.0 | V |
| Gate-Source Leakage | I_{GSS} | $V_{GS} = \pm 20\text{ V}$ | - | - | ± 100 | nA |
| Zero Gate Voltage Drain Current | I_{DSS} | $V_{DS} = 450\text{ V}, V_{GS} = 0\text{ V}$ | - | - | 25 | μA |
| | | $V_{DS} = 360\text{ V}, V_{GS} = 0\text{ V}, T_J = 125\text{ }^\circ\text{C}$ | - | - | 250 | |
| Drain-Source On-State Resistance | $R_{DS(on)}$ | $V_{GS} = 10\text{ V}, I_D = 2.9\text{ A}^b$ | - | - | 1.2 | Ω |
| Forward Transconductance | g_{fs} | $V_{DS} = 50\text{ V}, I_D = 2.9\text{ A}^b$ | 3.0 | - | - | S |
| Dynamic | | | | | | |
| Input Capacitance | C_{iss} | $V_{GS} = 0\text{ V},$ $V_{DS} = 25\text{ V},$ $f = 1.0\text{ MHz}$, see fig. 5 | - | 680 | - | pF |
| Output Capacitance | C_{oss} | | - | 190 | - | |
| Reverse Transfer Capacitance | C_{rss} | | - | 75 | - | |
| Total Gate Charge | Q_g | $V_{GS} = 10\text{ V}, I_D = 4.9\text{ A}, V_{DS} = 360\text{ V}$ see fig. 6 and 13 ^b | - | - | 45 | nC |
| Gate-Source Charge | Q_{gs} | | - | - | 6.6 | |
| Gate-Drain Charge | Q_{gd} | | - | - | 24 | |
| Turn-On Delay Time | $t_{d(on)}$ | $V_{DD} = 225\text{ V}, I_D = 4.9\text{ A}$ $R_G = 12\text{ }\Omega, R_D = 45\text{ }\Omega$, see fig. 10 ^b | - | 5.9 | - | ns |
| Rise Time | t_r | | - | 22 | - | |
| Turn-Off Delay Time | $t_{d(off)}$ | | - | 40 | - | |
| Fall Time | t_f | | - | 21 | - | |
| Internal Drain Inductance | L_D | Between lead, 6 mm (0.25") from package and center of die contact  | - | 4.5 | - | nH |
| Internal Source Inductance | L_S | | - | 7.5 | - | |
| Drain-Source Body Diode Characteristics | | | | | | |
| Continuous Source-Drain Diode Current | I_S | MOSFET symbol showing the integral reverse p - n junction diode  | - | - | 4.9 | A |
| Pulsed Diode Forward Current ^a | I_{SM} | | - | - | 20 | |
| Body Diode Voltage | V_{SD} | $T_J = 25\text{ }^\circ\text{C}, I_S = 4.9\text{ A}, V_{GS} = 0\text{ V}^b$ | - | - | 2.0 | V |
| Body Diode Reverse Recovery Time | t_{rr} | $T_J = 25\text{ }^\circ\text{C}, I_F = 4.9\text{ A}, dI/dt = 100\text{ A}/\mu\text{s}^b$ | - | 460 | 690 | ns |
| Body Diode Reverse Recovery Charge | Q_{rr} | | - | 1.8 | 2.7 | μC |
| Forward Turn-On Time | t_{on} | Intrinsic turn-on time is negligible (turn-on is dominated by L_S and L_D) | | | | |

Notes

- a. Repetitive rating; pulse width limited by maximum junction temperature (see fig. 11).
- b. Pulse width $\leq 300\text{ }\mu\text{s}$; duty cycle $\leq 2\%$.

TYPICAL CHARACTERISTICS 25 °C, unless otherwise noted

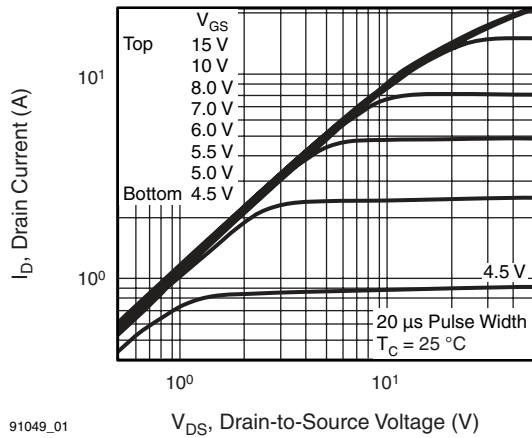

Fig. 1 - Typical Output Characteristics, $T_C = 25\text{ }^\circ\text{C}$

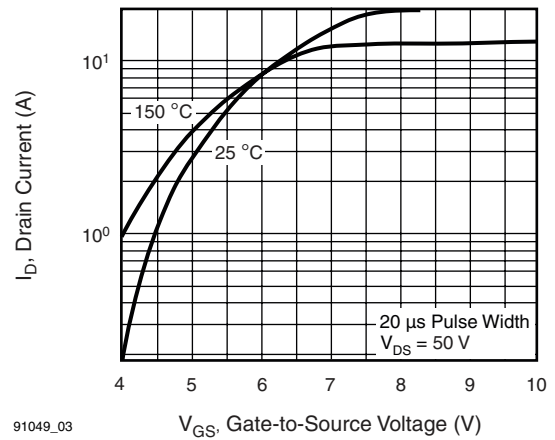

Fig. 3 - Typical Transfer Characteristics

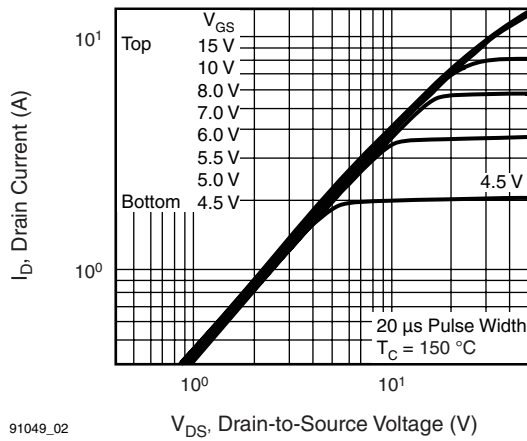

Fig. 2 - Typical Output Characteristics, $T_C = 150\text{ }^\circ\text{C}$

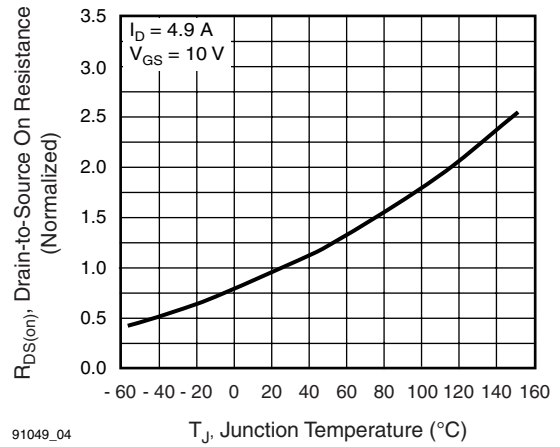
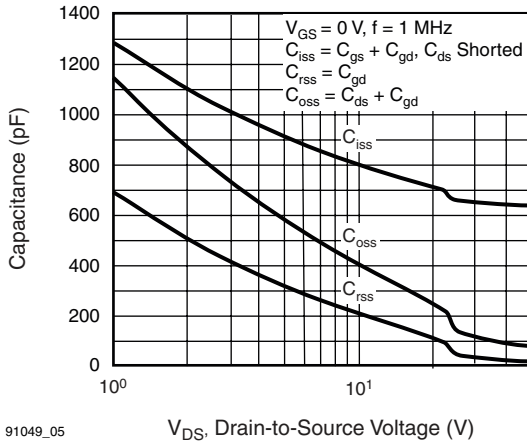
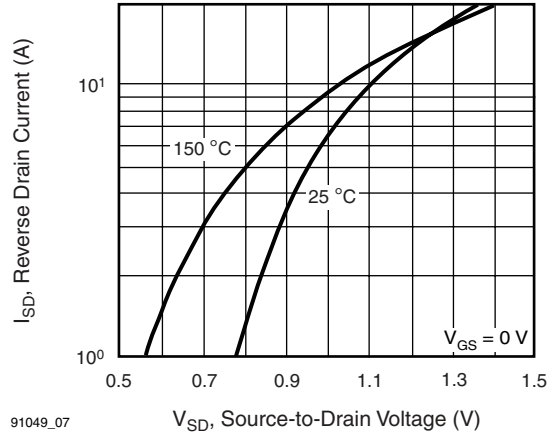

Fig. 4 - Normalized On-Resistance vs. Temperature



91049_05

Fig. 5 - Typical Capacitance vs. Drain-to-Source Voltage



91049_07

Fig. 7 - Typical Source-Drain Diode Forward Voltage

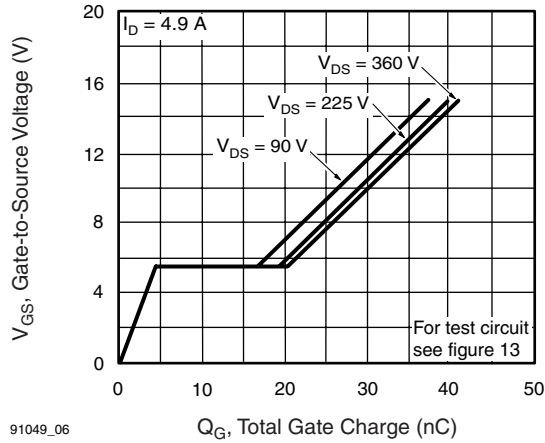

91049_06

Fig. 6 - Typical Gate Charge vs. Drain-to-Source Voltage

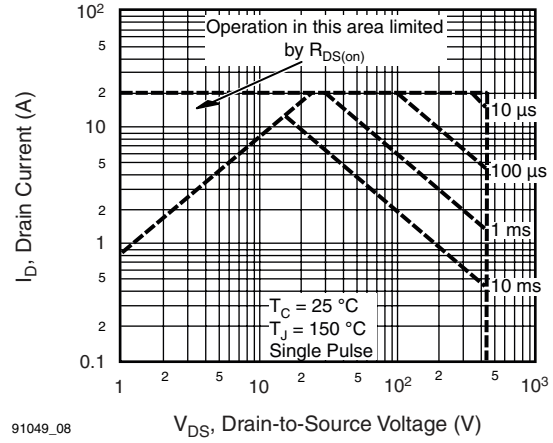

91049_08

Fig. 8 - Maximum Safe Operating Area

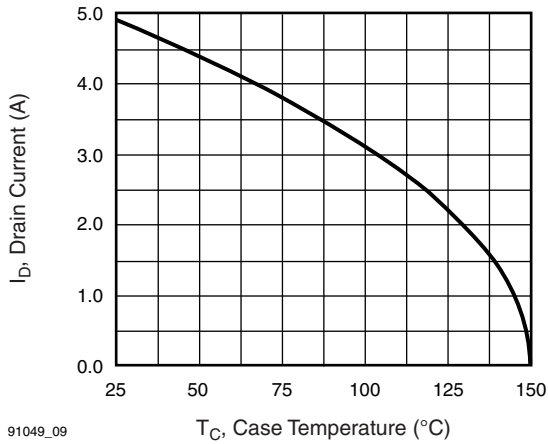

91049_09

Fig. 9 - Maximum Drain Current vs. Case Temperature

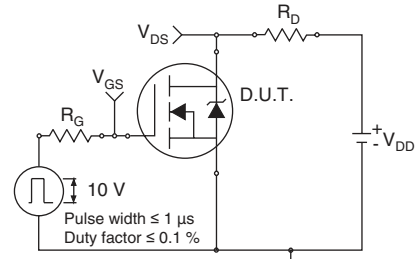

Fig. 10a - Switching Time Test Circuit

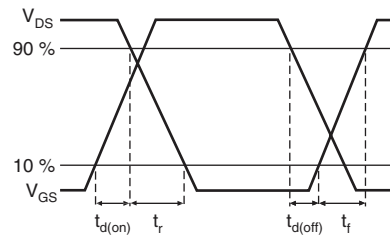
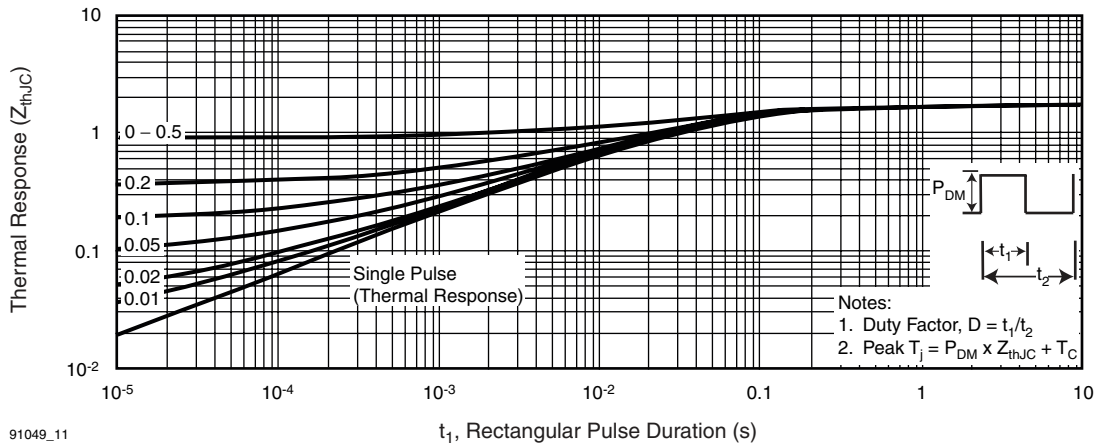

Fig. 10b - Switching Time Waveforms



91049_11

Fig. 11 - Maximum Effective Transient Thermal Impedance, Junction-to-Case

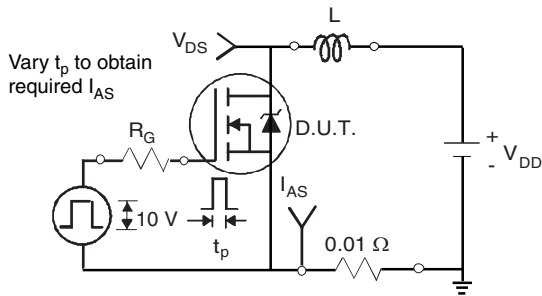

Fig. 12a - Unclamped Inductive Test Circuit

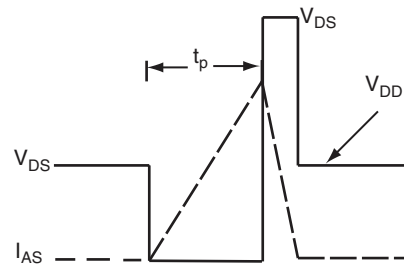

Fig. 12b - Unclamped Inductive Waveforms

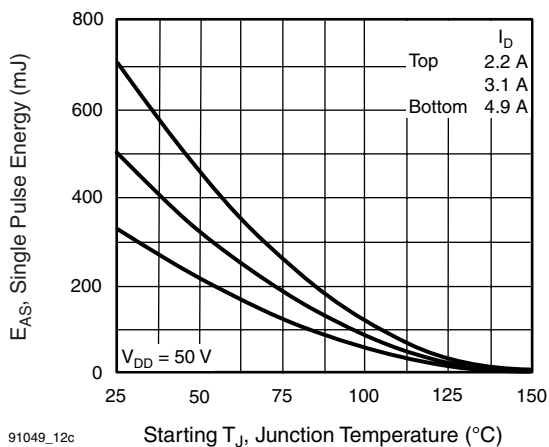

Fig. 12c - Maximum Avalanche Energy vs. Drain Current

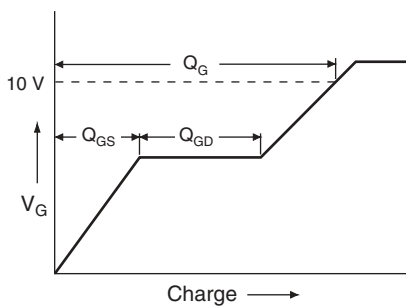

Fig. 13a - Basic Gate Charge Waveform

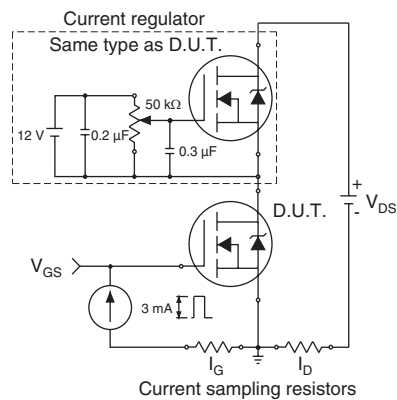
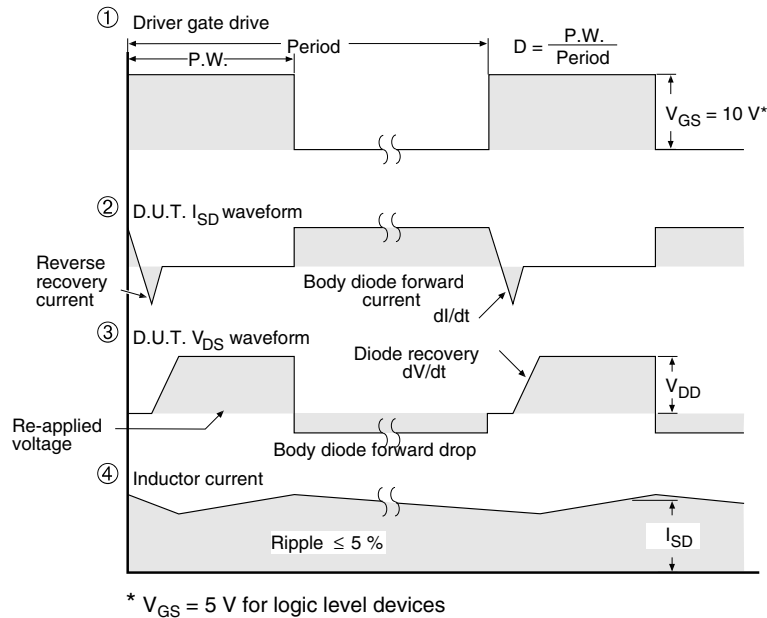
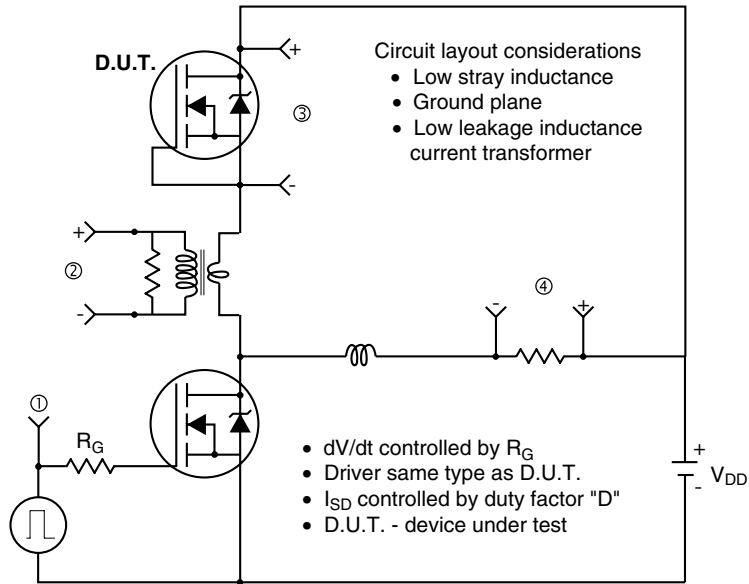

Fig. 13b - Gate Charge Test Circuit

Peak Diode Recovery dV/dt Test Circuit

Fig. 14 - For N-Channel

Vishay Siliconix maintains worldwide manufacturing capability. Products may be manufactured at one of several qualified locations. Reliability data for Silicon Technology and Package Reliability represent a composite of all qualified locations. For related documents such as package/tape drawings, part marking, and reliability data, see www.vishay.com/ppg?91049.



Disclaimer

All product specifications and data are subject to change without notice.

Vishay Intertechnology, Inc., its affiliates, agents, and employees, and all persons acting on its or their behalf (collectively, "Vishay"), disclaim any and all liability for any errors, inaccuracies or incompleteness contained herein or in any other disclosure relating to any product.

Vishay disclaims any and all liability arising out of the use or application of any product described herein or of any information provided herein to the maximum extent permitted by law. The product specifications do not expand or otherwise modify Vishay's terms and conditions of purchase, including but not limited to the warranty expressed therein, which apply to these products.

No license, express or implied, by estoppel or otherwise, to any intellectual property rights is granted by this document or by any conduct of Vishay.

The products shown herein are not designed for use in medical, life-saving, or life-sustaining applications unless otherwise expressly indicated. Customers using or selling Vishay products not expressly indicated for use in such applications do so entirely at their own risk and agree to fully indemnify Vishay for any damages arising or resulting from such use or sale. Please contact authorized Vishay personnel to obtain written terms and conditions regarding products designed for such applications.

Product names and markings noted herein may be trademarks of their respective owners.