



GARDTEC

Part Number:

AFM-60m

Material: Frame-0.6mm Aluminum

Mesh- 24#/25.4mm Stainless Steel

General Tolerance Unless Noted: $\pm 0.5\text{mm}$

Finish: Cleaning

Unit: mm

RoHS/REACH Compliant

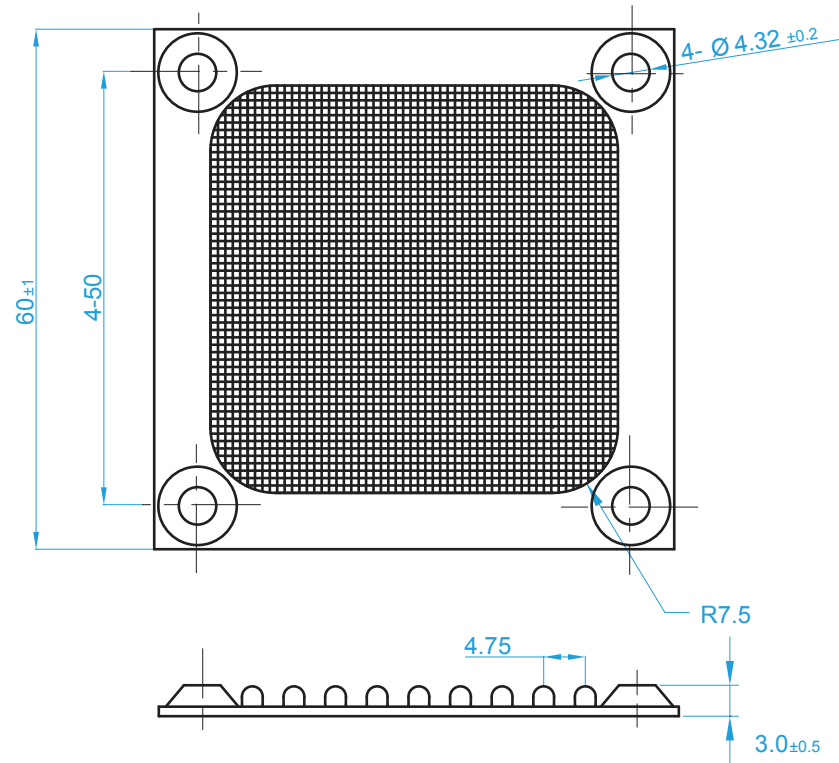

These drawings are the property of Gardtec, Inc and cannot be reproduced for or communicated to a third party without the express written permission of Gardtec, Inc.