

# MAX9647/MAX9648

## General-Purpose, Low-Voltage, Tiny Pack Comparators

### **General Description**

The MAX9647/MAX9648 comparators are drop-in, pin-for-pin compatible replacements for the LMX331/LMX331H. The MAX9648 has the added benefit of internal hysteresis to provide noise immunity, preventing output oscillations even with slow moving input signals.

Advantages of the ICs include low supply voltage, small package, and low cost. They also offer a wide supply voltage range, wide operating temperature range, competitive CMRR and PSRR, response time characteristics, input offset, low noise, output saturation voltage, input bias current, and RF immunity.

The ICs are available in both 5-pin SC70 and SOT23 packages.

### **Applications**

Mobile Communications  
Notebooks and PDAs  
Battery-Powered Electronics  
General-Purpose Portable Devices  
General-Purpose Low-Voltage Applications

### **Features**

- ◆ **Guaranteed +1.8V to +5.5V Performance**
- ◆ **-40°C to +125°C Automotive Temperature Range**
- ◆ **Low Supply Current (60µA/Channel at V<sub>DD</sub> = +5.0V)**
- ◆ **Input Common-Mode Voltage Range Includes Ground**
- ◆ **No Phase Reversal for Overdriven Inputs**
- ◆ **Low Output Saturation Voltage (120mV)**
- ◆ **Internal 2mV Hysteresis (MAX9648)**
- ◆ **5-Pin SC70 Space-Saving Package (2.0mm x 2.1mm x 1.0mm)**

*[Ordering Information](#) appears at end of data sheet.*

# MAX9647/MAX9648

## General-Purpose, Low-Voltage, Tiny Pack Comparators

### ABSOLUTE MAXIMUM RATINGS

Supply Voltage ( $V_{DD}$ to $V_{SS}$ ).....	-0.3V to +6V	SOT23 (derate 3.9mW/°C above +70°C) .....	312.6mW
All Other Pins Except OUT.....	( $V_{SS} - 0.3V$ ) to ( $V_{DD} + 0.3V$ )	Operating Temperature Range .....	-40°C to +125°C
Differential Input Voltage (IN+ to IN-) .....	±3.6V	Junction Temperature .....	+150°C
OUT .....	( $V_{SS} - 0.3V$ ) to +6V	Storage Temperature Range.....	-65°C to +150°C
Continuous Power Dissipation ( $T_A = +70°C$ )		Lead Temperature (soldering, 10s) .....	+300°C
SC70 (derate 3.1mW/°C above +70°C).....	247mW	Soldering Temperature (reflow) .....	+260°C

Stresses beyond those listed under "Absolute Maximum Ratings" may cause permanent damage to the device. These are stress ratings only, and functional operation of the device at these or any other conditions beyond those indicated in the operational sections of the specifications is not implied. Exposure to absolute maximum rating conditions for extended periods may affect device reliability.

### PACKAGE THERMAL CHARACTERISTICS (Note 1)

SC70	Junction-to-Ambient Thermal Resistance ( $\theta_{JA}$ ).....	324°C/W	SOT23	Junction-to-Ambient Thermal Resistance ( $\theta_{JA}$ ).....	255.9°C/W
	Junction-to-Case Thermal Resistance ( $\theta_{JC}$ ).....	115°C/W		Junction-to-Case Thermal Resistance ( $\theta_{JC}$ ).....	81°C/W

**Note 1:** Package thermal resistances were obtained using the method described in JEDEC specification JESD51-7, using a four-layer board. For detailed information on package thermal considerations, refer to [www.maximintegrated.com/thermal-tutorial](http://www.maximintegrated.com/thermal-tutorial).

### DC ELECTRICAL CHARACTERISTICS—2.7V OPERATION

( $V_{DD} = 2.7V$ ,  $V_{SS} = 0V$ ,  $V_{CM} = 0V$ ,  $R_L = 5.1k\Omega$  connected to  $V_{DD}$ , typical values are at  $T_A = +25°C$ , unless otherwise noted. **Boldface** limits apply at the defined temperature extremes.) (Note 2)

PARAMETER	SYMBOL	CONDITIONS	MIN	TYP	MAX	UNITS
Input Offset Voltage	$V_{OS}$			0.4	7	mV
Input Voltage Hysteresis	$V_{HYST}$	MAX9648 only		2		mV
Input Offset Voltage Average Temperature Drift	$TCV_{OS}$			1.5		$\mu V/°C$
Input Bias Current	$I_B$	$T_A = +25°C$		±0.0003	±250	nA
		$T_A = -40°C$ to +85°C			<b>±400</b>	
		$T_A = -40°C$ to +125°C			<b>±400</b>	
Input Offset Current	$I_{OS}$	$T_A = +25°C$		±0.0003	±50	nA
		$T_A = -40°C$ to +85°C			<b>±150</b>	
		$T_A = -40°C$ to +125°C			<b>±150</b>	
Input Voltage Range	$V_{CM}$			-0.1		V
				2.0		
Voltage Gain	$A_V$	MAX9647 only		500		V/mV
Output Saturation Voltage	$V_{SAT}$	$I_{SINK} \leq 1mA$		25		mV
Output Sink Current	$I_O$	$V_O \leq 1.5V$	5	16		mA
Supply Current	$I_S$	(Note 3)		52	100	$\mu A$
Output Leakage Current		$T_A = +25°C$		0.005		$\mu A$
		$T_A = -40°C$ to +85°C			<b>1</b>	
		$T_A = -40°C$ to +125°C			<b>2</b>	

# MAX9647/MAX9648

## General-Purpose, Low-Voltage, Tiny Pack Comparators

### AC ELECTRICAL CHARACTERISTICS—2.7V OPERATION

( $V_{DD} = 2.7V$ ,  $V_{SS} = 0V$ ,  $V_{CM} = 0V$ ,  $R_L = 5.1k\Omega$  connected to  $V_{DD}$ , typical values are at  $T_A = +25^\circ C$ , unless otherwise noted. **Boldface** limits apply at the defined temperature extremes.) (Note 2)

PARAMETER	SYMBOL	CONDITIONS	MIN	TYP	MAX	UNITS
Propagation Delay Output High to Low (Note 4)	$t_{PHL}$	Input overdrive = 10mV		70		ns
		Input overdrive = 100mV		50		
Propagation Delay Output Low to High (Note 4)	$t_{PLH}$	Input overdrive = 10mV		115		ns
		Input overdrive = 100mV		100		

### DC ELECTRICAL CHARACTERISTICS—5.0V OPERATION

( $V_{DD} = 5V$ ,  $V_{SS} = 0V$ ,  $V_{CM} = 0V$ ,  $R_L = 5.1k\Omega$  connected to  $V_{DD}$ , typical values are at  $T_A = +25^\circ C$ , unless otherwise noted. **Boldface** limits apply at the defined temperature extremes.) (Note 2)

PARAMETER	SYMBOL	CONDITIONS	MIN	TYP	MAX	UNITS
Input Offset Voltage	$V_{OS}$	$T_A = +25^\circ C$		0.4	7	mV
		$T_A = -40^\circ C$ to $+85^\circ C$			<b>9</b>	
		$T_A = -40^\circ C$ to $+125^\circ C$			<b>9</b>	
Input Voltage Hysteresis		MAX9648 only		2		mV
Input Offset Voltage Average Temperature Drift	$TCV_{OS}$			1.5		$\mu V/^\circ C$
Input Bias Current	$I_B$	$T_A = +25^\circ C$		$\pm 0.007$	$\pm 250$	nA
		$T_A = -40^\circ C$ to $+85^\circ C$			<b><math>\pm 400</math></b>	
		$T_A = -40^\circ C$ to $+125^\circ C$			<b><math>\pm 400</math></b>	
Input Offset Current	$I_{OS}$	$T_A = +25^\circ C$		$\pm 0.007$	$\pm 50$	nA
		$T_A = -40^\circ C$ to $+85^\circ C$			<b><math>\pm 150</math></b>	
		$T_A = -40^\circ C$ to $+125^\circ C$			<b><math>\pm 150</math></b>	
Input Voltage Range	$V_{CM}$			-0.1		V
				4.2		
Voltage Gain	$A_V$	MAX9647 only	20	500		V/mV
Output Saturation Voltage	$V_{SAT}$	$I_{SINK} \leq 4mA$	$T_A = +25^\circ C$	120	400	mV
			$T_A = -40^\circ C$ to $+85^\circ C$		<b>700</b>	
			$T_A = -40^\circ C$ to $+125^\circ C$		<b>700</b>	
Output Sink Current	$I_O$	$V_O \leq 1.5V$	10	35		mA
Supply Current (Note 3)	$I_S$	$T_A = +25^\circ C$		60	120	$\mu A$
		$T_A = -40^\circ C$ to $+85^\circ C$			<b>150</b>	
		$T_A = -40^\circ C$ to $+125^\circ C$			<b>170</b>	
Output Leakage Current		$T_A = +25^\circ C$		0.005		$\mu A$
		$T_A = -40^\circ C$ to $+85^\circ C$			<b>1</b>	
		$T_A = -40^\circ C$ to $+125^\circ C$			<b>2</b>	

# MAX9647/MAX9648

## General-Purpose, Low-Voltage, Tiny Pack Comparators

### AC ELECTRICAL CHARACTERISTICS—5.0V OPERATION

( $V_{DD} = 5V$ ,  $V_{SS} = 0V$ ,  $V_{CM} = 0V$ ,  $R_L = 5.1k\Omega$  connected to  $V_{DD}$ , typical values are at  $T_A = +25^\circ C$ , unless otherwise noted. **Boldface** limits apply at the defined temperature extremes.) (Note 2)

PARAMETER	SYMBOL	CONDITIONS	MIN	TYP	MAX	UNITS
Propagation Delay Output High to Low (Note 4)	$t_{PHL}$	Input overdrive = 10mV		70		ns
		Input overdrive = 100mV		50		
Propagation Delay Output Low to High (Note 4)	$t_{PLH}$	Input overdrive = 10mV		110		ns
		Input overdrive = 100mV		100		

### DC ELECTRICAL CHARACTERISTICS—1.8V OPERATION

( $V_{DD} = 1.8V$ ,  $V_{SS} = 0V$ ,  $V_{CM} = 0V$ ,  $R_L = 5.1k\Omega$  connected to  $V_{DD}$ , typical values are at  $T_A = +25^\circ C$ , unless otherwise noted. **Boldface** limits apply at the defined temperature extremes.) (Note 2)

PARAMETER	SYMBOL	CONDITIONS	MIN	TYP	MAX	UNITS
Input Offset Voltage	$V_{OS}$			0.4	5	mV
Input Voltage Hysteresis		MAX9648 only		2		mV
Input Offset Voltage Average Temperature Drift	$TCV_{OS}$			1.5		$\mu V/^\circ C$
Input Bias Current	$I_B$			0.0003		nA
Input Offset Current	$I_{OS}$			0.0003		nA
Input Voltage Range	$V_{CM}$			-0.1		V
				1		
Output Saturation Voltage	$V_{SAT}$	$I_{SINK} \leq 1mA$		56		mV
Power-Supply Rejection Ratio	PSRR	$V_{DD} = 1.8V$ to 5.5V	60	90		dB
Output Sink Current	$I_O$	$V_O \leq 1.5V$		6.4		mA
Supply Current	$I_S$	(Note 3)		50	100	$\mu A$
Output Leakage Current				0.001		$\mu A$

### AC ELECTRICAL CHARACTERISTICS—1.8V OPERATION

( $V_{DD} = 1.8V$ ,  $V_{SS} = 0V$ ,  $V_{CM} = 0V$ ,  $R_L = 5.1k\Omega$  connected to  $V_{DD}$ , typical values are at  $T_A = +25^\circ C$ , unless otherwise noted. **Boldface** limits apply at the defined temperature extremes.) (Note 2)

PARAMETER	SYMBOL	CONDITIONS	MIN	TYP	MAX	UNITS
Propagation Delay Output High to Low (Note 4)	$t_{PHL}$	Input overdrive = 10mV		70		ns
		Input overdrive = 100mV		60		
Propagation Delay Output Low to High (Note 4)	$t_{PLH}$	Input overdrive = 10mV		120		ns
		Input overdrive = 100mV		110		

**Note 2:** All devices are production tested at  $T_A = +25^\circ C$ . All temperature limits are guaranteed by design.

**Note 3:** Supply current when output is high.

**Note 4:** Input overdrive is the overdrive voltage beyond the offset and hysteresis-determined trip points.

# MAX9647/MAX9648

## General-Purpose, Low-Voltage, Tiny Pack Comparators

### Typical Operating Characteristics

( $V_{DD} = 5V$ ,  $V_{SS} = 0V$ ,  $V_{CM} = 0V$ ,  $R_L = 5.1k\Omega$ ,  $C_L = 10pF$ , overdrive = 100mV,  $T_A = +25^\circ C$ , unless otherwise noted.)

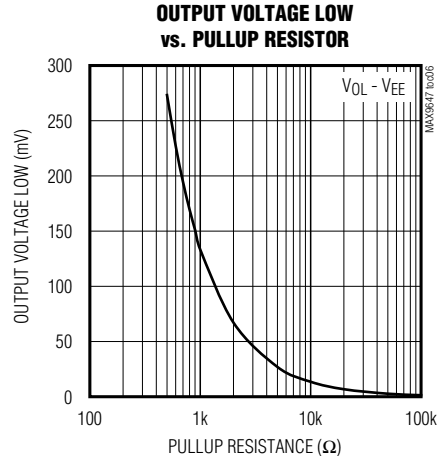
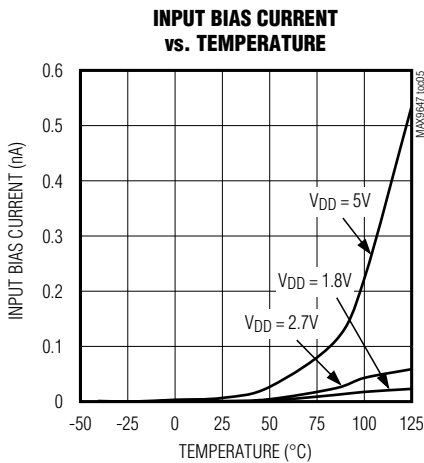
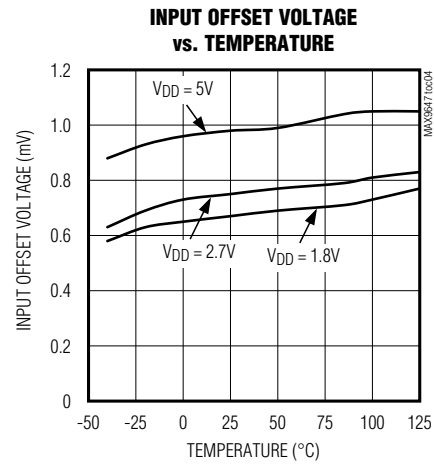
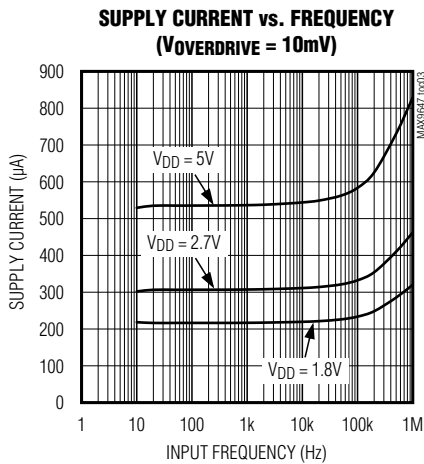
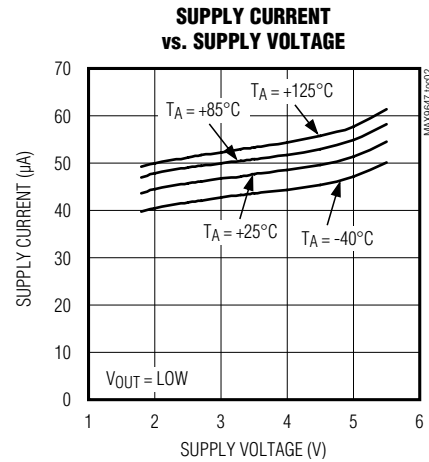
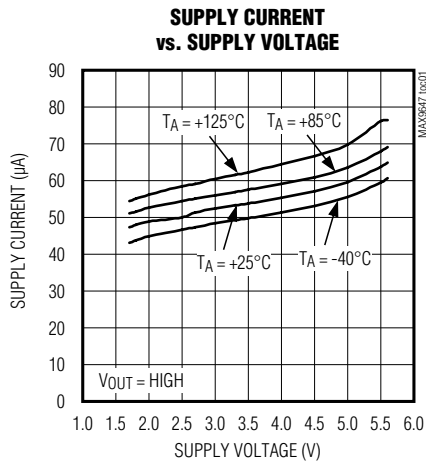

# MAX9647/MAX9648

## General-Purpose, Low-Voltage, Tiny Pack Comparators

### Typical Operating Characteristics (continued)

( $V_{DD} = 5V$ ,  $V_{SS} = 0V$ ,  $V_{CM} = 0V$ ,  $R_L = 5.1k\Omega$ ,  $C_L = 10pF$ , overdrive = 100mV,  $T_A = +25^\circ C$ , unless otherwise noted.)

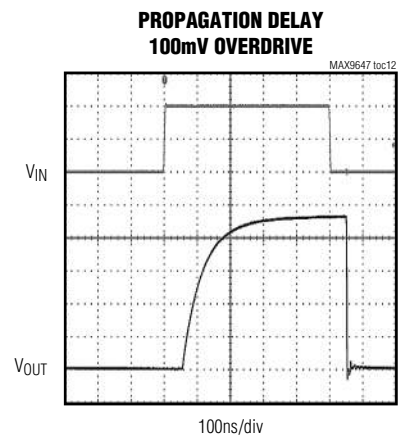
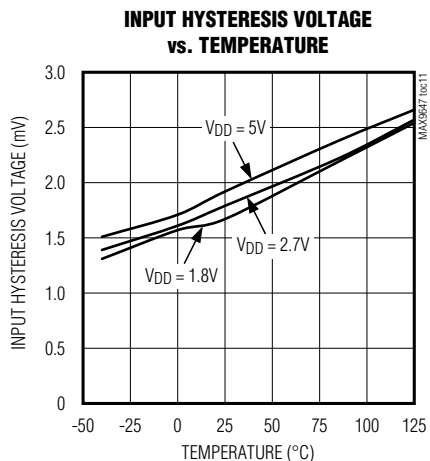
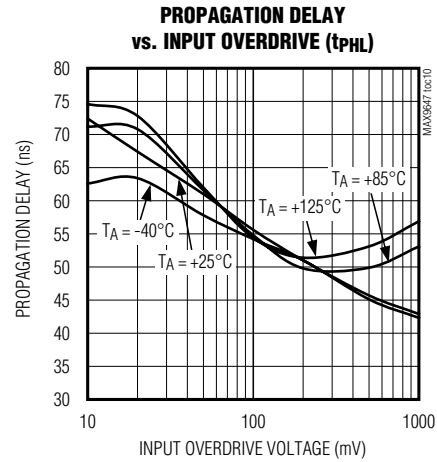
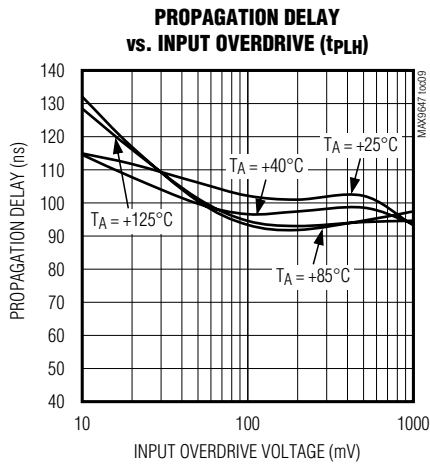
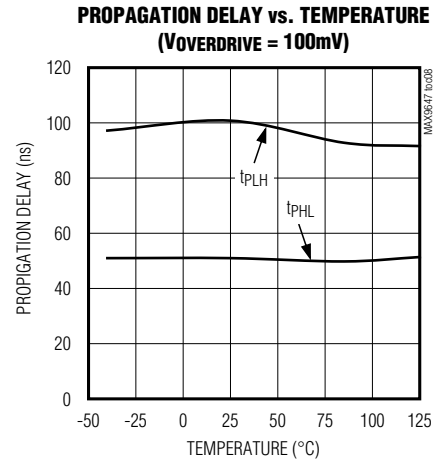
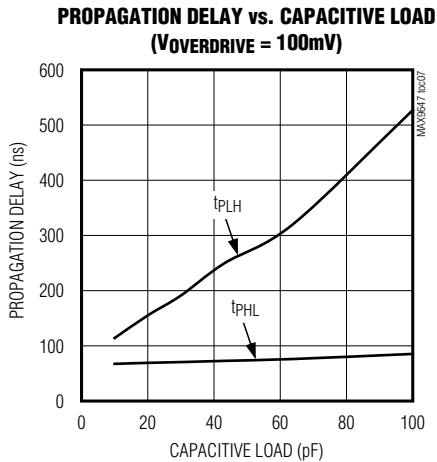

# MAX9647/MAX9648

## General-Purpose, Low-Voltage, Tiny Pack Comparators

### Typical Operating Characteristics (continued)

( $V_{DD} = 5V$ ,  $V_{SS} = 0V$ ,  $V_{CM} = 0V$ ,  $R_L = 5.1k\Omega$ ,  $C_L = 10pF$ , overdrive = 100mV,  $T_A = +25^\circ C$ , unless otherwise noted.)

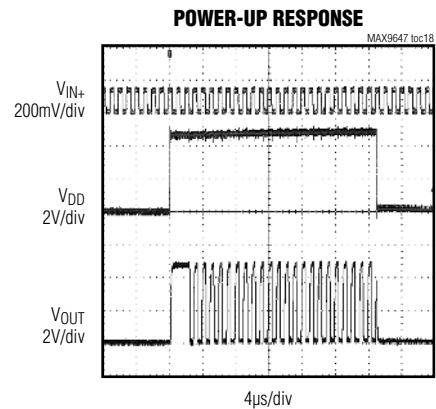
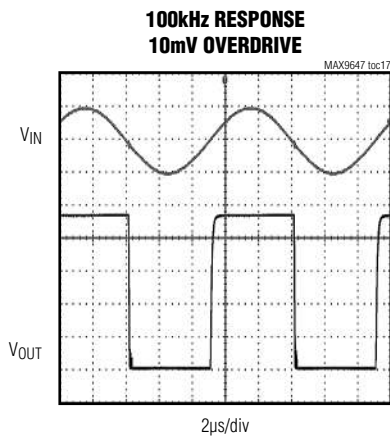
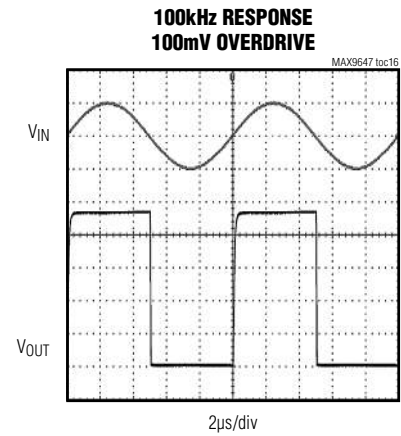
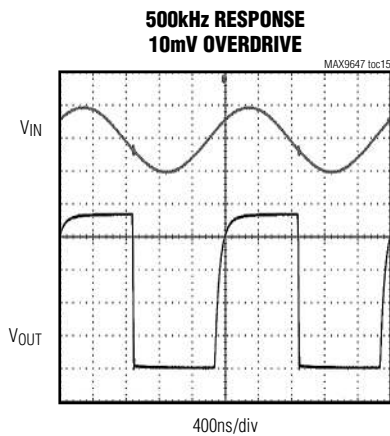
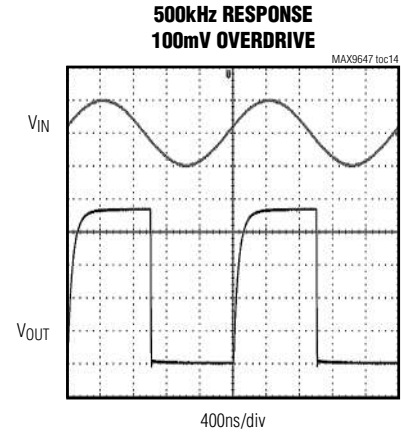
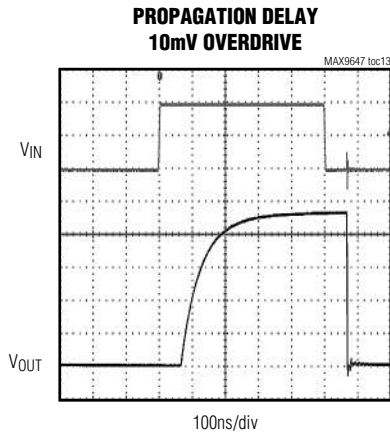

# MAX9647/MAX9648

## General-Purpose, Low-Voltage, Tiny Pack Comparators

### Pin Configuration

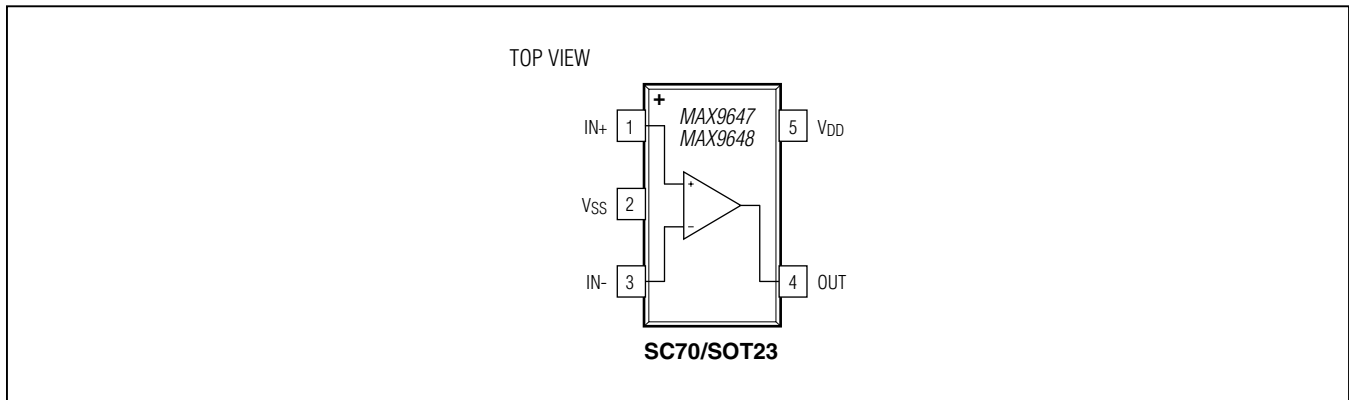

### Pin Description

PIN	NAME	FUNCTION
1	IN+	Noninverting Input
2	V <sub>SS</sub>	Negative Supply (Connect to GND)
3	IN-	Inverting Input
4	OUT	Comparator Output (Open Drain)
5	V <sub>DD</sub>	Positive Supply

### Detailed Description

The MAX9647/MAX9648 are low-cost, general-purpose comparators that have a single-supply +1.8V to +5V operating voltage range. The common-mode input range extends from -0.1V below the negative supply to within +0.7V of the positive supply. They require approximately 60μA per comparator with a 5V supply and 52μA with a 2.7V supply.

The MAX9648 has 2mV of hysteresis for noise immunity. This significantly reduces the chance of output oscillations even with slow-moving input signals. See the [Typical Operating Characteristics](#).

### Applications Information

#### Hysteresis

Many comparators oscillate in the linear region of operation because of noise or undesired parasitic feedback. This tends to occur when the voltage on one input is equal or very close to the voltage on the other input. The MAX9648 has internal hysteresis to counter parasitic effects and noise.

The hysteresis in a comparator creates two trip points: one for the rising input voltage and one for the falling input voltage ([Figure 1](#)). The difference between the trip points is the hysteresis. When the comparator's input voltages are equal, the hysteresis effectively causes one comparator input to move quickly past the other, thus taking the input out of the region where oscillation occurs. This provides clean output transitions for noisy, slow-moving input signals.



# MAX9647/MAX9648

## General-Purpose, Low-Voltage, Tiny Pack Comparators

Additional hysteresis can be generated with two resistors using positive feedback (Figure 2). Use the following procedure to calculate resistor values:

- 1) Find output voltage when output is high:

$$V_{OUT(HIGH)} = V_{DD} - I_{LOAD} \times R_L$$

- 2) Find the trip points of the comparator using these formulas:

$$V_{TH} = V_{REF} + ((V_{OUT(HIGH)} - V_{REF})R_2)/(R_1 + R_2)$$

$$V_{TL} = V_{REF} (1 - (R_2/(R_1 + R_2)))$$

where  $V_{TH}$  is the threshold voltage at which the comparator switches its output from high to low as  $V_{IN}$  rises above the trip point, and  $V_{TL}$  is the threshold voltage at which the comparator switches its output from low to high as  $V_{IN}$  drops below the trip point.

- 3) The hysteresis band is:

$$V_{HYST} = V_{TH} - V_{TL} = V_{DD}(R_2/(R_1 + R_2))$$

In this example, let  $V_{DD} = 5V$ ,  $V_{REF} = 2.5V$ ,  $I_{LOAD} = 50nA$ , and  $R_L = 5.1k\Omega$ .

$$V_{OUT(HIGH)} = 5.0V - (50 \times 10^{-9} \times 5.1 \times 10^3\Omega) \approx 5.0V$$

$$V_{TH} = 2.5 + 2.5(R_2/(R_1 + R_2))$$

$$V_{TL} = 2.5(1 - (R_2/(R_1 + R_2)))$$

Select  $R_2$ . In this example, choose  $1k\Omega$ .

Select  $V_{HYST}$ . In this example, choose  $50mV$ .

Solve for  $R_1$ .

$$V_{HYST} = V_{OUT(HIGH)}(R_2/(R_1 + R_2))V$$

$$0.050V = 5(1000/(R_1 + 1000))V$$

where  $R_1 \approx 100k\Omega$ ,  $V_{TH} = 2.525V$ , and  $V_{TL} = 2.475V$

Choose  $R_1$  and  $R_2$  to be large enough as not to exceed the amount of current the reference can supply.

The source current required is  $V_{REF}/(R_1 + R_2)$ .

The sink current is  $(V_{OUT(HIGH)} - V_{REF}) \times (R_1 + R_2)$ .

Choose  $R_L$  to be large enough to avoid drawing excess current, yet small enough to supply the necessary current to drive the load.  $R_L$  should be between  $1k\Omega$  and  $10k\Omega$ . Choose  $R_1$  to be much larger than  $R_L$  to avoid lowering  $V_{OUT(HIGH)}$  or raising  $V_{OUT(LOW)}$ .

### Board Layout and Bypassing

Use  $0.1\mu F$  bypass capacitors from  $V_{DD}$  to  $V_{SS}$ . To maximize performance, minimize stray inductance by putting this capacitor close to the  $V_{DD}$  pin and reducing trace lengths. For slow moving input signals (rise time  $> 1ms$ ), use a  $1nF$  capacitor between  $IN+$  and  $IN-$  to reduce high-frequency noise.

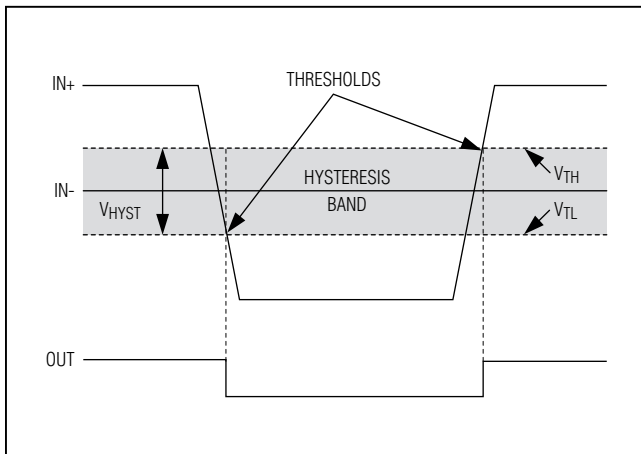

Figure 1. Threshold Hysteresis Band (Not to Scale)

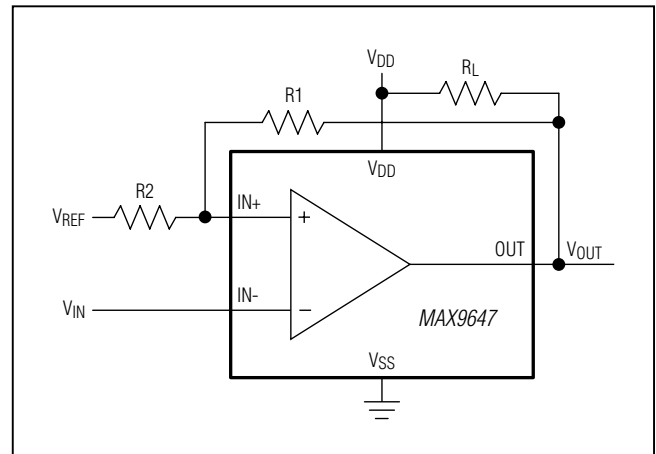

Figure 2. Adding Hysteresis with External Resistors

# MAX9647/MAX9648

## General-Purpose, Low-Voltage, Tiny Pack Comparators

### Chip Information

PROCESS: BiCMOS

### Ordering Information

PART	TEMP RANGE	PIN-PACKAGE	TOP MARK
<b>MAX9647</b> AXK+T	-40°C to +125°C	5 SC70	+AUS
MAX9647AUK+T	-40°C to +125°C	5 SOT23	+AFLM
<b>MAX9648</b> AXK+T	-40°C to +125°C	5 SC70	+AUT
MAX9648AUK+T	-40°C to +125°C	5 SOT23	+AFLN

+Denotes a lead(Pb)-free/RoHS-compliant package.

T = Tape and reel.

### Package Information

For the latest package outline information and land patterns (footprints), go to [www.maximintegrated.com/packages](http://www.maximintegrated.com/packages). Note that a "+", "#", or "-" in the package code indicates RoHS status only. Package drawings may show a different suffix character, but the drawing pertains to the package regardless of RoHS status.

PACKAGE TYPE	PACKAGE CODE	OUTLINE NO.	LAND PATTERN NO.
5 SC70	X5+1	<a href="#">21-0076</a>	<a href="#">90-0188</a>
5 SOT23	U5+1	<a href="#">21-0057</a>	<a href="#">90-0174</a>

# MAX9647/MAX9648

## General-Purpose, Low-Voltage, Tiny Pack Comparators

### Revision History

REVISION NUMBER	REVISION DATE	DESCRIPTION	PAGES CHANGED
0	10/11	Initial release	—
1	1/12	Revised the <i>Typical Operating Characteristics</i> .	6
2	1/13	Updated the <i>Absolute Maximum Ratings</i> , added the <i>Package Thermal Characteristics</i> , and revised the <i>Electrical Characteristics</i> .	2–4
3	4/15	No <i>V</i> OPNs; deleted “Automotive Applications” from <i>Applications</i> section and automotive reference from <i>Detailed Description</i> section	1, 8



Maxim Integrated cannot assume responsibility for use of any circuitry other than circuitry entirely embodied in a Maxim Integrated product. No circuit patent licenses are implied. Maxim Integrated reserves the right to change the circuitry and specifications without notice at any time. The parametric values (min and max limits) shown in the Electrical Characteristics table are guaranteed. Other parametric values quoted in this data sheet are provided for guidance.

**Maxim Integrated 160 Rio Robles, San Jose, CA 95134 USA 1-408-601-1000**

11