

MAX987/MAX988/MAX991/ MAX992/MAX995/MAX996

High-Speed, Micropower, Low-Voltage, Rail-to-Rail I/O Comparators

General Description

The MAX987/MAX988/MAX991/MAX992/MAX995/MAX996 single/dual/quad micropower comparators feature low-voltage operation and rail-to-rail inputs and outputs. Their operating voltage ranges from +2.5V to +5.5V, making them ideal for both 3V and 5V systems. These comparators also operate with $\pm 1.25V$ to $\pm 2.75V$ dual supplies. They consume only 48 μA per comparator while achieving a 120ns propagation delay.

Input bias current is typically 1.0pA, and input offset voltage is typically 0.5mV. Internal hysteresis ensures clean output switching, even with slow-moving input signals.

The output stage's unique design limits supply-current surges while switching, virtually eliminating the supply glitches typical of many other comparators. The MAX987/MAX991/MAX995 have a push-pull output stage that sinks as well as sources current. Large internal output drivers allow rail-to-rail output swing with loads up to 8mA. The MAX988/MAX992/MAX996 have an open-drain output stage that can be pulled beyond V_{CC} to 6V (max) above V_{EE} . These open-drain versions are ideal for level translators and bipolar to single-ended converters.

The single MAX987/MAX988 are available in tiny 5-pin SC70 packages, while the dual MAX991/MAX992 are available in ultra-small μMAX^{\circledR} package.

Selector Guide

PART	COMPARATORS PER PACKAGE	OUTPUT STAGE
MAX987	1	Push-Pull
MAX988	1	Open-Drain
MAX991	2	Push-Pull
MAX992	2	Open-Drain
MAX995	4	Push-Pull
MAX996	4	Open-Drain

Applications

- Portable/Battery-Powered Systems
- Mobile Communications
- Zero-Crossing Detectors
- Window Comparators
- Level Translators
- Threshold Detectors/Discriminators
- Ground/Supply Sensing
- IR Receivers
- Digital Line Receivers

μMAX is a registered trademark of Maxim Integrated Products, Inc.

Benefits and Features

- 120ns Propagation Delay
- 48 μA Quiescent Supply Current
- +2.5V to +5.5V Single-Supply Operation
- Common-Mode Input Voltage Range Extends 250mV Beyond the Rails
- Push-Pull Output Stage Sinks and Sources 8mA Current (MAX987/MAX991/MAX995)
- Open-Drain Output Voltage Extends Beyond V_{CC} (MAX988/MAX992/MAX996)
- Unique Output Stage Reduces Output Switching Current, Minimizing Overall Power Consumption
- 100 μA Supply Current at 1MHz Switching Frequency
- No Phase Reversal for Overdriven Inputs
- Available in Space-Saving Packages:
 - 5-Pin SC70 (MAX987/MAX988)
 - 8-Pin μMAX (MAX991/MAX992)

Ordering Information

PART	PIN-PACKAGE	PKG CODE	TOP MARK
MAX987EXK-T	5 SC70-5	X5-1	ABM
MAX987ESA	8 SO	S8-2	—

Ordering Information continued at end of data sheet.

Note: All devices specified over the $-40^{\circ}C$ to $+85^{\circ}C$ operating temperature range.

Typical Application Circuit appears at end of data sheet.

Pin Configurations

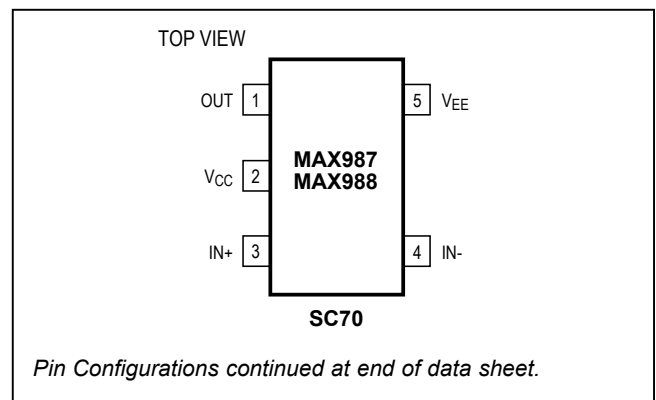

MAX987/MAX988/MAX991/
MAX992/MAX995/MAX996

High-Speed, Micropower, Low-Voltage,
Rail-to-Rail I/O Comparators

Absolute Maximum Ratings

Supply Voltage (V_{CC} to V_{EE}).....	6V	8-Pin SO (derate 5.88mW/°C above +70°C).....	471mW
IN ₋ , IN ₊ to V_{EE}	-0.3V to (V_{CC} + 0.3V)	8-Pin μ MAX (derate 4.5mW/°C above +70°C).....	362mW
Current into Input Pins	\pm 20mA	14-Pin TSSOP (derate 9.1mW/°C above +70°C).....	727mW
OUT ₋ to V_{EE}		14-Pin SO (derate 8.33mW/°C above +70°C).....	667mW
MAX987/MAX991/MAX995	-0.3V to (V_{CC} + 0.3V)	Operating Temperature Range.....	-40°C to +85°C
MAX988/MAX992/MAX996	-0.3V to +6V	Storage Temperature Range.....	-65°C to +150°C
OUT ₋ Short-Circuit Duration to V_{EE} or V_{CC}	10s	Lead Temperature (soldering, 10s)	+300°C
Continuous Power Dissipation (T_A = +70°C)			
5-Pin SC70 (derate 3.1mW/°C above +70°C).....	247mW		

Stresses beyond those listed under "Absolute Maximum Ratings" may cause permanent damage to the device. These are stress ratings only, and functional operation of the device at these or any other conditions beyond those indicated in the operational sections of the specifications is not implied. Exposure to absolute maximum rating conditions for extended periods may affect device reliability.

Electrical Characteristics (Note 1)

(V_{CC} = +2.7V to +5.5V, V_{EE} = 0V, V_{CM} = 0V, T_A = -40°C to +85°C, unless otherwise noted. Typical values are at T_A = +25°C.)

PARAMETER	SYMBOL	CONDITIONS		MIN	TYP	MAX	UNITS
Supply Voltage	V_{CC}	Inferred from PSRR test		2.5		5.5	V
Supply Current per Comparator	I_{CC}	V_{CC} = 5V	T_A = +25°C		53	80	μ A
			T_A = -40°C to +85°C			96	
		V_{CC} = 2.7V	T_A = +25°C		48	80	
			T_A = -40°C to +85°C			96	
Power-Supply Rejection Ratio	PSRR	$2.5V \leq V_{CC} \leq 5.5V$		55	80		dB
Common-Mode Voltage Range (Note 2)	V_{CMR}	T_A = +25°C		$V_{EE} - 0.25$		$V_{CC} + 0.25$	V
		T_A = -40°C to +85°C		V_{EE}		V_{CC}	
Input Offset Voltage (Note 3)	V_{OS}	Full common-mode range	T_A = +25°C		\pm 0.5	\pm 5	mV
			T_A = -40°C to +85°C			\pm 7	
Input Hysteresis	V_{HYST}				\pm 2.5		mV
Input Bias Current (Note 4)	I_B				0.001	10	nA
Input Offset Current	I_{OS}				0.5		pA
Input Capacitance	C_{IN}				1.0		pF
Common-Mode Rejection Ratio	CMRR			50	80		dB
Output Leakage Current (MAX988/MAX992/MAX996 only)	I_{LEAK}	V_{OUT} = high				1.0	μ A
Output Short-Circuit Current	I_{SC}	Sourcing or sinking, V_{OUT} = V_{EE} or V_{CC}	V_{CC} = 5V		95		mA
			V_{CC} = 2.7V		35		
OUT Output-Voltage Low	V_{OL}	V_{CC} = 5V, I_{SINK} = 8mA	T_A = +25°C		0.2	0.4	V
			T_A = -40°C to +85°C			0.55	
		V_{CC} = 2.7V, I_{SINK} = 3.5mA	T_A = +25°C		0.15	0.3	
			T_A = -40°C to +85°C			0.4	
OUT Output-Voltage High (MAX987/MAX991/MAX995 Only)	V_{OH}	V_{CC} = 5V, I_{SOURCE} = 8mA	T_A = +25°C	4.6	4.85		V
			T_A = -40°C to +85°C	4.45			
		V_{CC} = 2.7V, I_{SOURCE} = 3.5mA	T_A = +25°C	2.4	2.55		
			T_A = -40°C to +85°C	2.3			

Electrical Characteristics (continued)

($V_{CC} = +2.7V$ to $+5.5V$, $V_{EE} = 0V$, $V_{CM} = 0V$, $T_A = -40^{\circ}C$ to $+85^{\circ}C$, unless otherwise noted. Typical values are at $T_A = +25^{\circ}C$.)

PARAMETER	SYMBOL	CONDITIONS		MIN	TYP	MAX	UNITS
OUT Rise Time (MAX987/MAX991/ MAX995 Only)	t_{RISE}	$V_{CC} = 5.0V$	$C_L = 15pF$		15		ns
			$C_L = 50pF$		20		
			$C_L = 200pF$		40		
OUT Fall Time	t_{FALL}	$V_{CC} = 5.0V$	$C_L = 15pF$		15		ns
			$C_L = 50pF$		20		
			$C_L = 200pF$		40		
Propagation Delay	t_{PD-}	$C_L = 15pF$, $V_{CC} = 5V$	MAX987/MAX991/ MAX995 only	10mV overdrive		210	ns
				100mV overdrive		120	
			MAX988/MAX992/ MAX996 only, $R_{PULLUP} = 5.1k\Omega$	10mV overdrive		210	
				100mV overdrive		120	
	t_{PD+}	MAX987/MAX991/MAX995 only, $C_L = 15pF$, $V_{CC} = 5V$	10mV overdrive		210		
			100mV overdrive		120		
Power-Up Time	t_{PU}				25		μs

Note 1: All device specifications are 100% production tested at $T_A = +25^{\circ}C$. Limits over the extended temperature range are guaranteed by design, not production tested.

Note 2: Inferred from the V_{OS} test. Either or both inputs can be driven 0.3V beyond either supply rail without output phase reversal.

Note 3: V_{OS} is defined as the center of the hysteresis band at the input.

Note 4: I_B is defined as the average of the two input bias currents (I_{B-} , I_{B+}).

Typical Operating Characteristics

($V_{CC} = +5V$, $V_{CM} = 0V$, $T_A = +25^\circ C$, unless otherwise noted.)

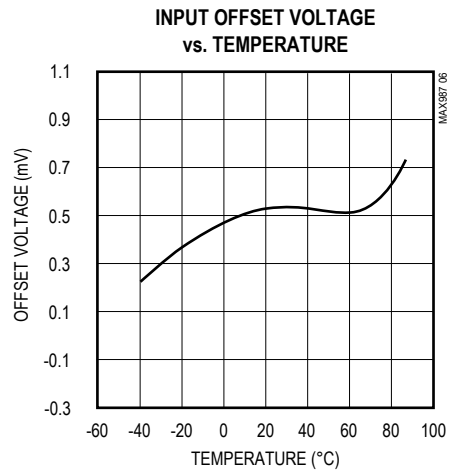
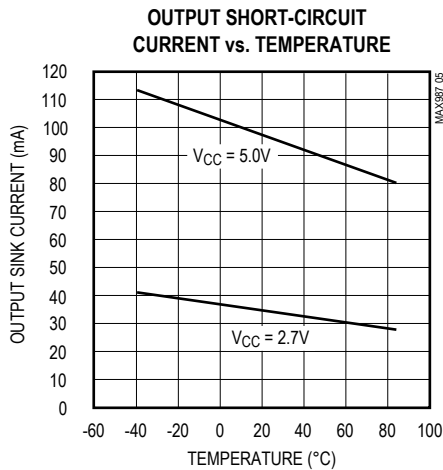
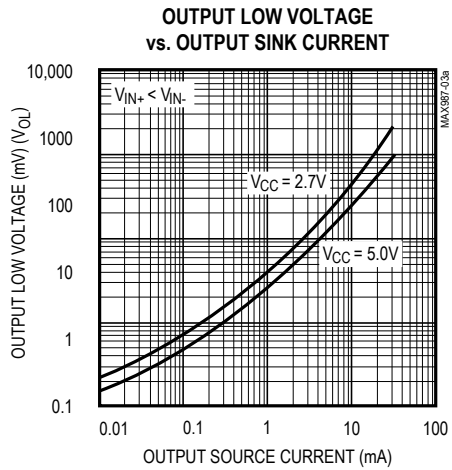
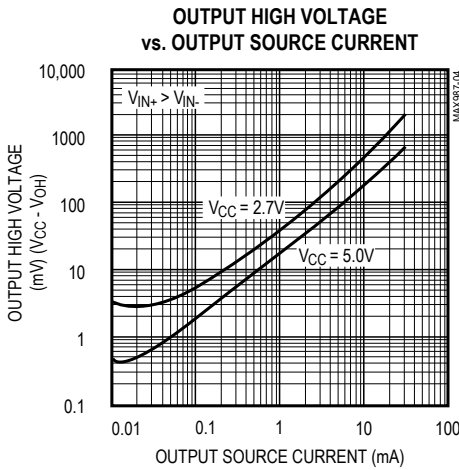
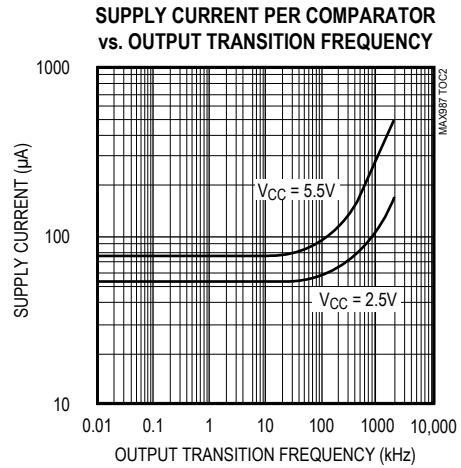
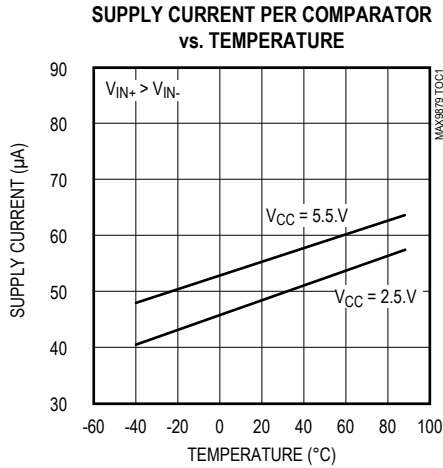

Typical Operating Characteristics (continued)

($V_{CC} = +5V$, $V_{CM} = 0V$, $T_A = +25^\circ C$, unless otherwise noted.)

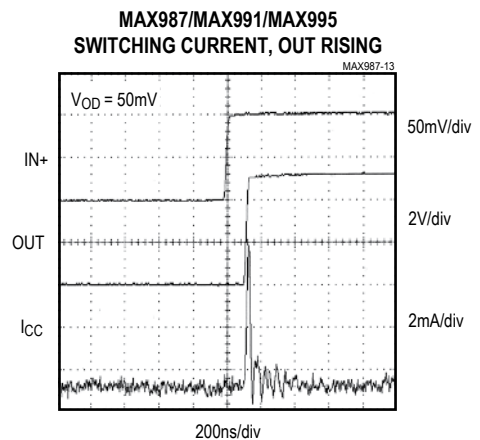
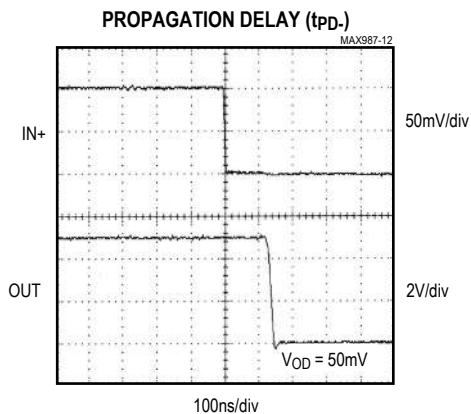
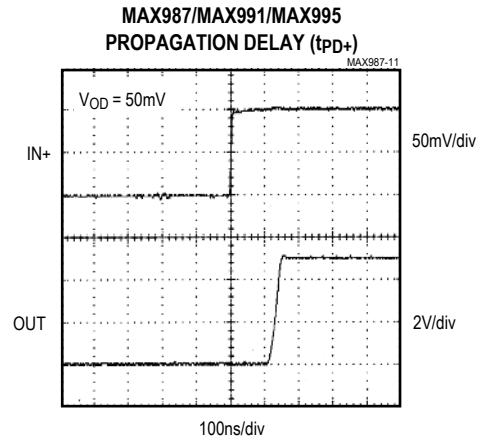
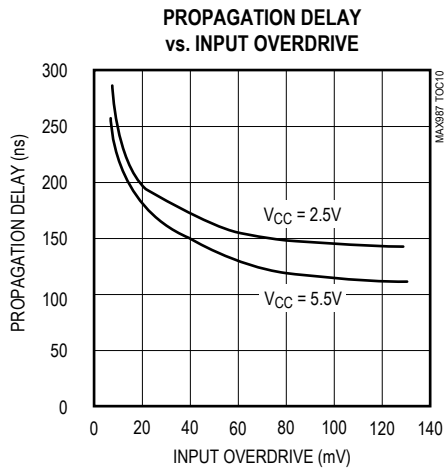
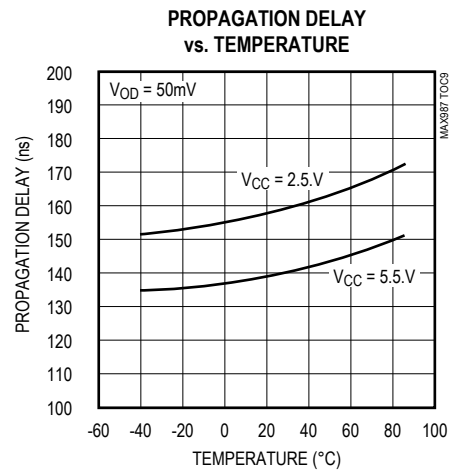
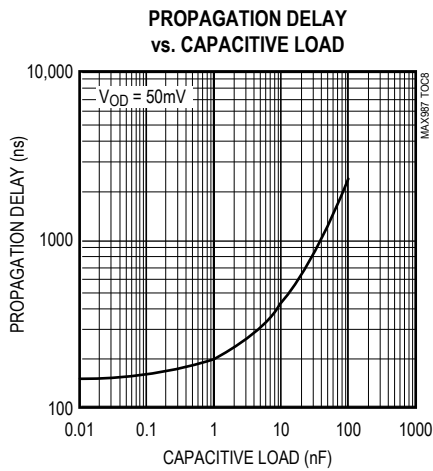

Typical Operating Characteristics (continued)

($V_{CC} = +5V$, $V_{CM} = 0V$, $T_A = +25^\circ C$, unless otherwise noted.)

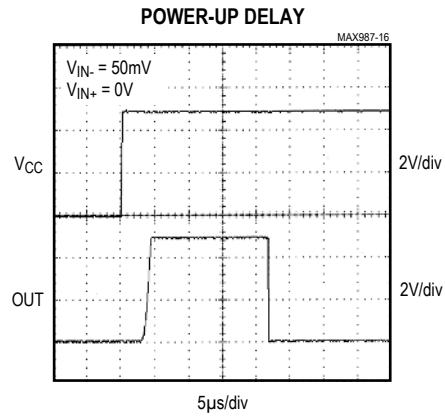
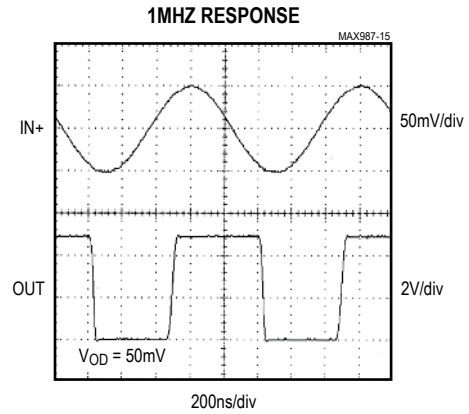
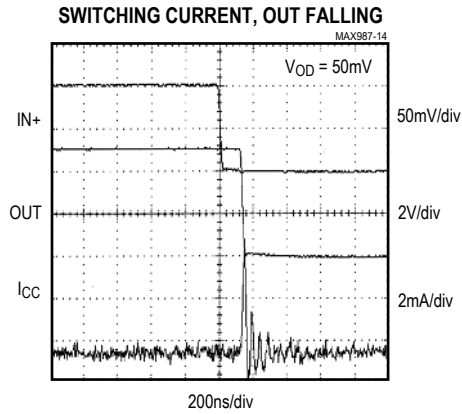

Pin Description

PIN				NAME	FUNCTION
MAX987 MAX988		MAX991 MAX996	MAX995 MAX996		
SC70	SO	SO/ μ MAX/	SO/ TSSOP		
1	6	—	—	OUT	Comparator Output
2	7	8	4	V _{CC}	Positive Supply Voltage
3	3	—	—	IN+	Comparator Noninverting Input
4	2	—	—	IN-	Comparator Inverting Input
5	4	4	11	V _{EE}	Negative Supply Voltage
—	—	1	1	OUTA	Comparator A Output
—	—	2	2	INA-	Comparator A Inverting Input
—	—	3	3	INA+	Comparator A Noninverting Input
—	—	5	5	INB+	Comparator B Noninverting Input
—	—	6	6	INB-	Comparator B Inverting Input
—	—	7	7	OUTB	Comparator B Output
—	—	—	8	OUTC	Comparator C Output
—	—	—	9	INC-	Comparator C Inverting Input
—	—	—	10	INC+	Comparator C Noninverting Input
—	—	—	12	IND+	Comparator D Noninverting Input
—	—	—	13	IND-	Comparator D Inverting Input
—	—	—	14	OUTD	Comparator D Output
—	1, 5, 8	—	—	N.C.	No Connection. Not internally connected.

MAX987/MAX988/MAX991/ MAX992/MAX995/MAX996

High-Speed, Micropower, Low-Voltage, Rail-to-Rail I/O Comparators

Detailed Description

The MAX987/MAX988/MAX991/MAX992/MAX995/MAX996 are single/dual/quad low-power, low-voltage comparators. They have an operating supply voltage range between +2.5V and +5.5V and consume only 48µA per comparator, while achieving 120ns propagation delay. Their common-mode input voltage range extends 0.25V beyond each rail. Internal hysteresis ensures clean output switching, even with slow-moving input signals. Large internal output drivers allow rail-to-rail output swing with up to 8mA loads.

The output stage employs a unique design that minimizes supply-current surges while switching, virtually eliminating the supply glitches typical of many other comparators. The MAX987/MAX991/MAX995 have a push-pull output structure that sinks as well as sources current. The MAX988/MAX992/MAX996 have an open-drain output stage that can be pulled beyond V_{CC} to an absolute maximum of 6V above V_{EE} .

Input Stage Circuitry

The devices' input common-mode range extends from -0.25V to ($V_{CC} + 0.25V$). These comparators may operate at any differential input voltage within these limits. Input bias current is typically 1.0pA if the input voltage is between the supply rails. Comparator inputs are protected from overvoltage by internal body diodes connected to the supply rails. As the input voltage exceeds the supply rails, these body diodes become forward biased and begin to conduct. Consequently, bias currents increase exponentially as the input voltage exceeds the supply rails.

Output Stage Circuitry

These comparators contain a unique output stage capable of rail-to-rail operation with up to 8mA loads. Many comparators consume orders of magnitude more current during switching than during steady-state operation. However, with this family of comparators, the supply-current change during an output transition is extremely small. The Supply Current vs. Output Transition Frequency graph in the [Typical Operating Characteristics](#) section shows the minimal supply-current increase as the output switching frequency approaches 1MHz. This characteristic eliminates the need for power-supply filter capacitors to reduce glitches created by comparator switching currents. Battery life increases substantially in high-speed, battery-powered applications.

Applications Information

Additional Hysteresis

MAX987/MAX991/MAX995

The MAX987/MAX991/MAX995 have $\pm 2.5mV$ internal hysteresis. Additional hysteresis can be generated with three resistors using positive feedback (Figure 1). Unfortunately, this method also slows hysteresis response time. Use the following procedure to calculate resistor values for the MAX987/MAX991/MAX995.

- 1) Select R3. Leakage current at I_N is under 10nA; therefore, the current through R3 should be at least 1µA to minimize errors caused by leakage current. The current through R3 at the trip point is $(V_{REF} - V_{OUT}) / R3$. Considering the two possible output states and solving for R3 yields two formulas: $R3 = V_{REF} / 1\mu A$ or $R3 = (V_{REF} - V_{CC}) / 1\mu A$. Use the smaller of the two resulting resistor values. For example, if $V_{REF} = 1.2V$ and $V_{CC} = 5V$, then the two R3 resistor values are 1.2MΩ and 3.8MΩ. Choose a 1.2MΩ standard value for R3.
- 2) Choose the hysteresis band required (V_{HB}). For this example, choose 50mV.
- 3) Calculate R1 according to the following equation:

$$R1 = R3 \times (V_{HB} / V_{CC})$$

For this example, insert the values $R1 = 1.2M\Omega \times (50mV / 5V) = 12k\Omega$.

- 4) Choose the trip point for V_{IN} rising (V_{THR} ; V_{THF} is the trip point for V_{IN} falling). This is the threshold voltage at which the comparator switches its output from low to high as V_{IN} rises above the trip point. For this example, choose 3V.

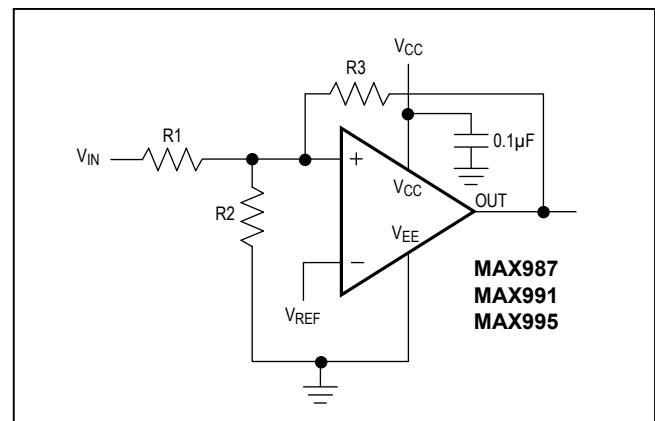

Figure 1. Additional Hysteresis (MAX987/MAX991/MAX995)

MAX987/MAX988/MAX991/ MAX992/MAX995/MAX996

- 5) Calculate R2 as shown. For this example, choose an 8.2kΩ standard value:

$$R2 = \frac{1}{\left(\frac{V_{THR}}{V_{REF} \times R1}\right) - \frac{1}{R1} - \frac{1}{R3}}$$

$$R2 = \frac{1}{\left(\frac{3.0V}{1.2 \times 12k\Omega}\right) - \frac{1}{12k\Omega} - \frac{1}{2.2M\Omega}} = 8.03k\Omega$$

- 6) Verify trip voltages and hysteresis as follows:

$$V_{IN \text{ rising}}: V_{THR} = V_{REF} \times R1 \times \left(\frac{1}{R1} + \frac{1}{R2} + \frac{1}{R3}\right)$$

$$V_{IN \text{ falling}}: V_{THF} = V_{THR} - \left(\frac{R1 \times V_{CC}}{R3}\right)$$

$$\text{Hysteresis} = V_{THR} - V_{THF}$$

MAX988/MAX992/MAX996

The MAX988/MAX992/MAX996 have ±2.5mV internal hysteresis. They have open-drain outputs and require an external pullup resistor (Figure 2). Additional hysteresis can be generated using positive feedback, but the formulas differ slightly from those of the MAX987/MAX991/MAX995.

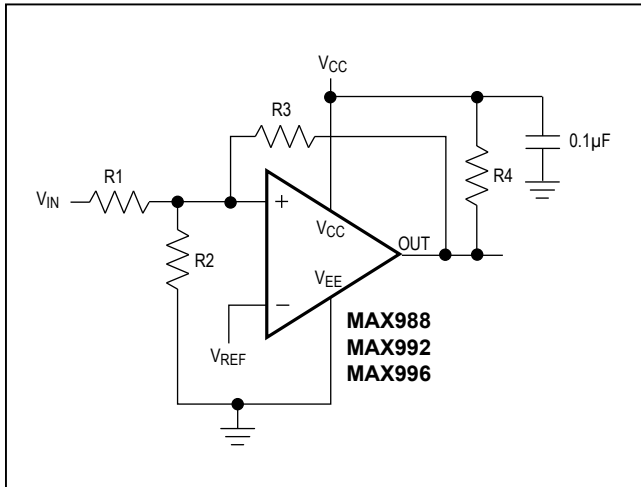

Figure 2. Additional Hysteresis (MAX988/MAX992/MAX996)

High-Speed, Micropower, Low-Voltage, Rail-to-Rail I/O Comparators

Use the following procedure to calculate resistor values:

- 1) Select R3 according to the formulas $R3 = V_{REF} / 1\mu A$ or $R3 = (V_{REF} - V_{CC}) / 1\mu A - R4$. Use the smaller of the two resulting resistor values.
- 2) Choose the hysteresis band required (V_{HB}). For this example, choose 50mV.
- 3) Calculate R1 according to the following equation:
$$R1 = (R3 + R4) \times (V_{HB} / V_{CC})$$
- 4) Choose the trip point for V_{IN} rising (V_{THR} ; V_{THF} is the trip point for V_{IN} falling). This is the threshold voltage at which the comparator switches its output from low to high as V_{IN} rises above the trip point.
- 5) Calculate R2 as follows:

$$R2 = \frac{1}{\left(\frac{V_{THR}}{V_{REF} \times R1}\right) - \frac{1}{R1} - \frac{1}{R3 + R4}}$$

- 6) Verify trip voltages and hysteresis as follows:

$$V_{IN \text{ rising}}: V_{THR} = V_{REF} \times R1 \times$$

$$\left(\frac{1}{R1} + \frac{1}{R2} + \frac{1}{R3 + R4}\right)$$

$$V_{IN \text{ falling}}: V_{THF} = V_{THR} - \left(\frac{R1 \times V_{CC}}{R3 + R4}\right)$$

$$\text{Hysteresis} = V_{THR} - V_{THF}$$

Circuit Layout and Bypassing

These comparators' high-gain bandwidth requires design precautions to maximize their high-speed capability. The recommended precautions are:

- 1) Use a PCB with an unbroken, low-inductance ground plane.
- 2) Place a decoupling capacitor (a 0.1µF ceramic capacitor is a good choice) as close to V_{CC} as possible.
- 3) On the inputs and outputs, keep lead lengths short to avoid unwanted parasitic feedback around the comparators.
- 4) Solder the devices directly to the PCB instead of using a socket.

Typical Application Circuit

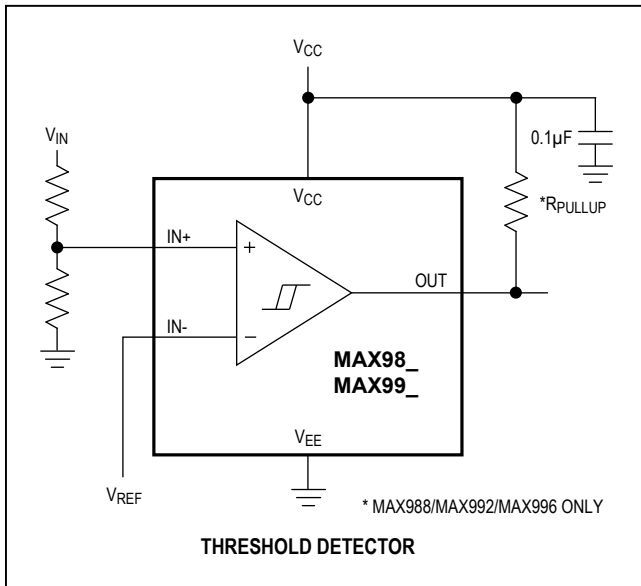

Ordering Information (continued)

PART	PIN-PACKAGE	PKG CODE	TOP MARK
MAX988EXK-T	5 SC70-5	X5-1	ABN
MAX988ESA	8 SO	S8-2	—
MAX991EUA-T	8 µMAX-8	U8-1	—
MAX991ESA	8 SO	S8-2	—
MAX992EUA-T	8 µMAX-8	U8-1	—
MAX992ESA	8 SO	S8-2	—
MAX995EUD	14 TSSOP	U14-1	—
MAX995ESD	14 SO	S14-4	—
MAX996EUD	14 TSSOP	U14-1	—
MAX996ESD	14 SO	S14-4	—

Note: All devices specified over the -40°C to +85°C operating temperature range.

Tape-and-Reel Information

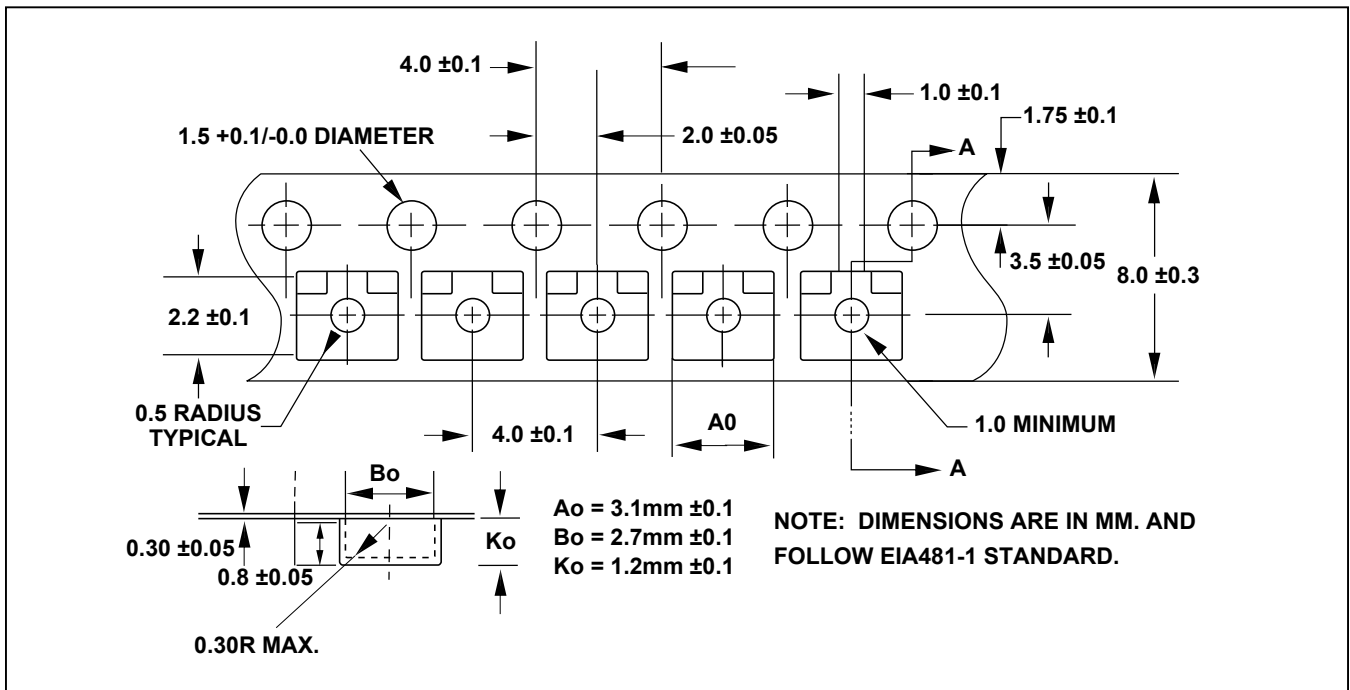

Package Information

For the latest package outline information and land patterns (footprints), go to www.maximintegrated.com/packages. Note that a "+", "#", or "-" in the package code indicates RoHS status only. Package drawings may show a different suffix character, but the drawing pertains to the package regardless of RoHS status.

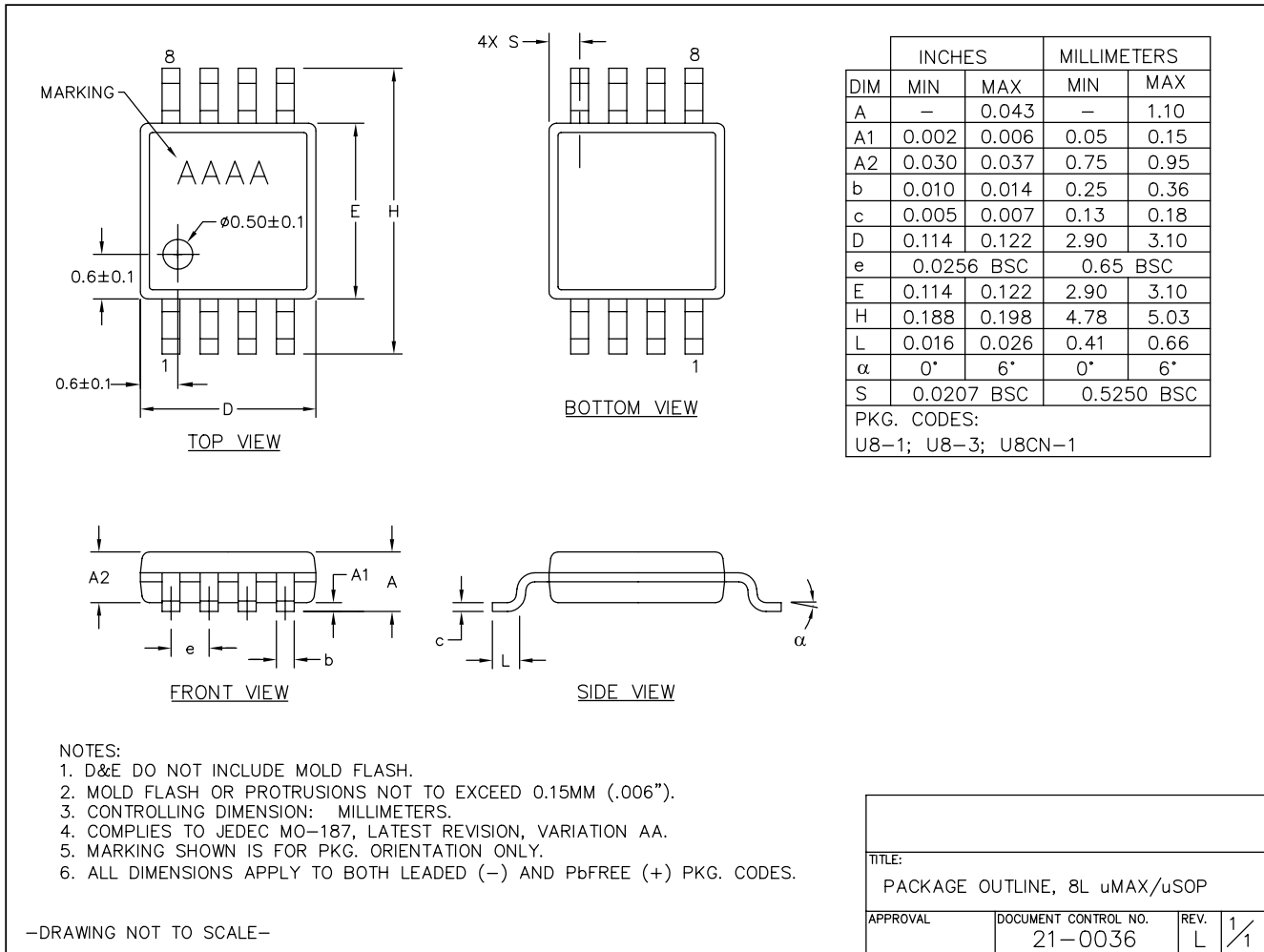

Revision History

REVISION NUMBER	DESCRIPTION	PAGES CHANGED
0	Initial Release	—
1	Final test limits added	—
2	Added input current ratings to <i>Absolute Maximum Ratings</i> table	—
3	Removed SOT23 package option	1–6, 8–13

For pricing, delivery, and ordering information, please contact Maxim Direct at 1-888-629-4642, or visit Maxim Integrated's website at www.maximintegrated.com.

Maxim Integrated cannot assume responsibility for use of any circuitry other than circuitry entirely embodied in a Maxim Integrated product. No circuit patent licenses are implied. Maxim Integrated reserves the right to change the circuitry and specifications without notice at any time. The parametric values (min and max limits) shown in the Electrical Characteristics table are guaranteed. Other parametric values quoted in this data sheet are provided for guidance.