

Features

Unregulated Converters

- Fully RoHS 6/6 Conform
- Full Power at 100°C Ambient Temperature
- 1kVDC or 3kVDC Isolation Options
- UL /CSA Certified, CB Report
- Suitable for Fully Automated Assembly (including Vapor Phase Soldering)
- Optional Continuous Short Circuit Protection
- Efficiency to 84%
- Built-In EN55022 Class A Filter

Description

The R1S and R1D converters are of the enclosed open frame type, i.e. they are not potted. The converters are typically used in general purpose and industrial low power isolation and voltage matching applications where an SMD converter is required.

The converter series feature an extended ambient temperature operating range of -40°C to +100°C without derating and optional continuous short circuit protection.

In addition to two isolation options and three different case formats, the converters are also available prepacked as tape and reel for use with automatic insertion machines.

Selection Guide

Part Number	SMD	Input Voltage (3kV)	Input Voltage (VDC)	Output Voltage (VDC)	Output Current (mA)	Efficiency (%)	Max Capacitive Load ⁽¹⁾
R1S**-xx3.3	(H)	3.3, 5, 12, 15, 24	3.3	303	75	2200µF	
R1S**-xx05	(H)	3.3, 5, 12, 15, 24	5	200	72-78	1000µF	
R1S**-xx09	(H)	3.3, 5, 12, 15, 24	9	111	74-78	1000µF	
R1S**-xx12	(H)	3.3, 5, 12, 15, 24	12	84	75-80	470µF	
R1S**-xx15	(H)	3.3, 5, 12, 15, 24	15	66	75-82	470µF	
R1S**-xx24	(H)	3.3, 5, 12, 15, 24	24	42	74-84	220µF	
R1D**-xx3.3	(H)	3.3, 5, 12, 15, 24	±3.3	±152	75	±1000µF	
R1D**-xx05	(H)	3.3, 5, 12, 15, 24	±5	±100	72-78	±470µF	
R1D**-xx09	(H)	3.3, 5, 12, 15, 24	±9	±56	74-78	±470µF	
R1D**-xx12	(H)	3.3, 5, 12, 15, 24	±12	±42	75-80	±220µF	
R1D**-xx15	(H)	3.3, 5, 12, 15, 24	±15	±33	75-82	±220µF	
R1D**-xx24	(H)	3.3, 5, 12, 15, 24	±24	±21	74-84	±100µF	

xx = Input Voltage (other input and output voltage combinations available on request)

* add Suffix "H" for 3kV Isolation, e.g. R1S-0505/H, R1D-0505/H, R1S12-0505/H, R1D12-0505/H

* add Suffix "P" for Continuous Short Circuit Protection, e.g. R1S8-0505/P, R1S-0505/HP, R1D12-0505/HP

* add suffix -R for tape & reel packing e.g. R1S-0505-R. For more details see Application Notes.

Case and Pinning Options (note restrictions on /H option)

R1S** : ** without marking denotes 5 pins out of 8 fitted (includes /H option)
 ** with marking **8** denotes 8 pins out of 8 fitted (/H option not available)
 ** with marking **12** denotes 10 pins out of 12 fitted (includes /H option)

R1D** : ** without marking denotes 6 pins out of 10 fitted (includes /H option)
 ** with marking **10** denotes with 10 pins out of 10 fitted (/H option not available)
 ** with marking **12** denotes 10 pins out of 12 fitted (includes /H option)

Specifications (measured at T_A = 25°C, nominal input voltage, full load and after warm-up)

Input Voltage Range		±10%
Output Voltage Accuracy		±2% typ., ±5% max.
Line Voltage Regulation	All Variants	1.2%/1% of Vin typ.
Load Voltage Regulation (10% to 100% full load)	3.3V output types	15% typ., 20% max.
	5V output type	12% typ., 15% max.
	9V output type	7% typ., 10% max.
	12V, 15V, 24V output types	6% typ., 10% max.
Output Ripple and Noise (20MHz BW limited)		50mVp-p typ., 100mVp-p max.
Operating Frequency		20kHz min. / 60kHz typ. / 100kHz max.

continued on next page

ECONOLINE

DC/DC-Converter

with 3 year Warranty

RECOM

1 Watt SMD Single & Dual Output



UL-60950-1 Certified
EN-60950-1 Certified
EN-60601-1 Certified*
 (* /H suffix)

R1S_R1D

Derating-Graph (Ambient Temperature)

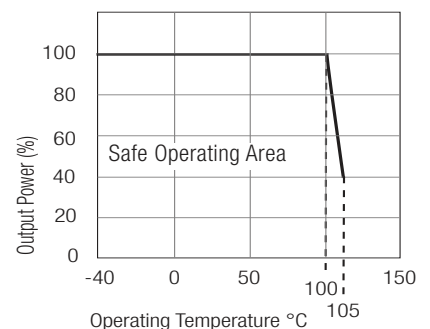

Specifications (measured at $T_A = 25^\circ\text{C}$, nominal input voltage, full load and after warm-up)

Efficiency at Full Load			See Selection Guide
Minimum Load = 0%			Specifications valid for 10% minimum load only.
Isolation Voltage	(tested for 1 second) (rated for 1 minute***)		1000VDC 500VAC / 60Hz
Isolation Voltage	H-Suffix H-Suffix	(tested for 1 second) (rated for 1 minute***)	3000VDC 1500VAC / 60Hz
Isolation Capacitance	R1S, R1S8, R1D, R1D10 R1S12, R1D12		15pF min. / 70pF max. 10pF min. / 75pF max.
Isolation Resistance			10 G Ω min.
Short Circuit Protection			1 Second
P-Suffix			Continuous
Operating Temperature Range (free air convection)			-40°C to +100°C (see Graph)
Storage Temperature Range			-55°C to +125°C
Reflow Temperature	ROHS compliant		245°C (30 sec), Peak 255°C (5 sec) max.
Vapor Phase Process	(for more details see Application Notes)		230°C (90 sec) max.
Relative Humidity			95% RH
Humidity Susceptibility Test			1000 hrs / 90% humidity / +85°C ambient
Package weight	R1S R1S8 R1S12, R1D, R1D10, R1D12		1.0g 1.1g 1.2g
Packing Quantity	R1S, R1S8 R1S12, R1D, R1D10, R1D12 All Types		40 pcs per Tube 33 pcs per tube 500 pcs per Reel
MTBF (+25°C) (+85°C)	} Detailed Information see Application Notes chapter "MTBF"	using MIL-HDBK 217F	4275 x 10 ³ hours
		using MIL-HDBK 217F	1365 x 10 ³ hours
Certifications			
CB Test Report	Report: US/14402A/UL		IEC 60950-1:2001 1st Ed.
UL General Safety	Report: E358085		UL 60950-1 2nd Ed.
CUL General Safety			C22.2 No. 60950-1-03
EN Medical Safety	Report: MDD1205098-2 + RM1205098-2 Medical Report + ISO14971 Risk Assessment		IEC/EN 60601-1 3rd Edition
EN General Safety	Report: SPCLVD1211033-3		EN60950-1: 2006 + A12:2011
Conducted / Radiated Emissions	EN55022		Level A

***Any data referred to in this datasheet are of indicative nature and based on our practical experience only. For further details, please refer to our Application Notes.

Notes

Note 1: Maximum capacitive load is defined as the capacitive load that will allow start up in under 1 second without damage to the converter.

Typical Characteristics

Tolerance Envelope

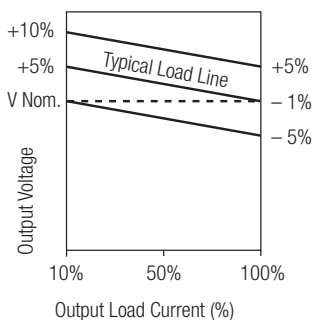

R1S**-xx05

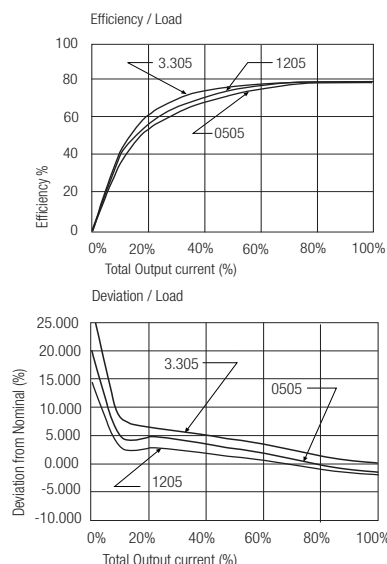

R1D**-xx05

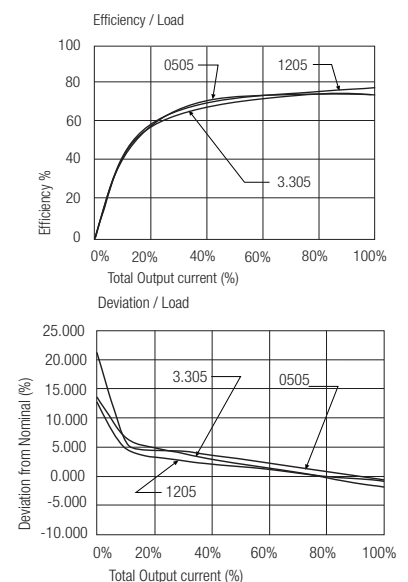

Package Style and Pinning (mm)

5 PIN Single SMD Package

Note: /H option is available in these pin packages

6 PIN Dual SMD Package

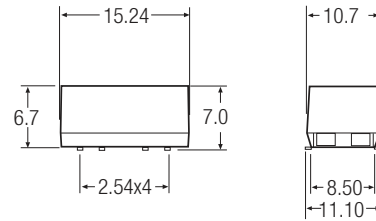
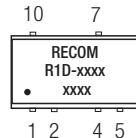
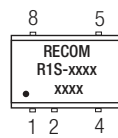
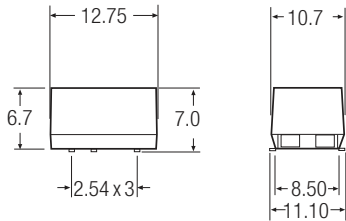

Recommended Footprint Details

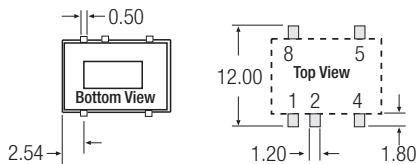

Pin Connections

Pin #	Single	Dual
1	-Vin	-Vin
2	+Vin	+Vin
4	-Vout	Com
5	+Vout	-Vout
7	No Pin	+Vout
8	NC	No Pin
10	No Pin	NC

NC = No Connection

XX.X ± 0.5 mm

XX.XX ± 0.25 mm

Recommended Footprint Details

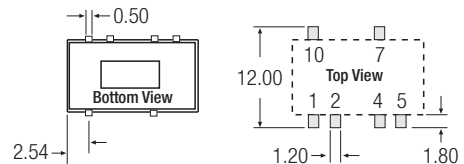

8 PIN Single SMD Package

Note: /H option is not available in these pin packages

10 PIN Dual SMD Package

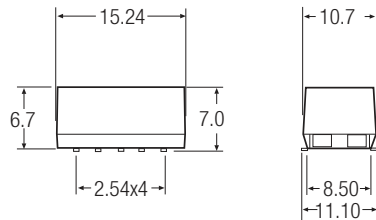
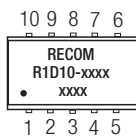
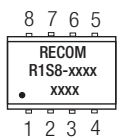
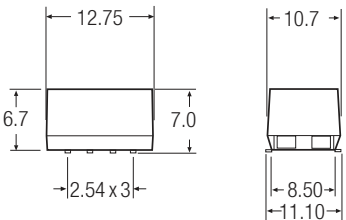

Recommended Footprint Details

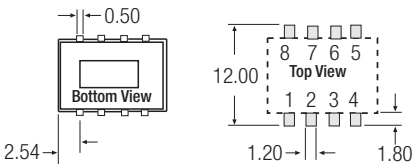

Pin Connections

Pin #	Single	Dual
1	-Vin	-Vin
2	+Vin	+Vin
3	NC	NC
4	-Vout	Com
5	+Vout	-Vout
6	NC	NC
7	NC	+Vout
8	NC	NC
9	-	NC
10	-	NC

NC = No Connection

XX.X ± 0.5 mm

XX.XX ± 0.25 mm

Recommended Footprint Details

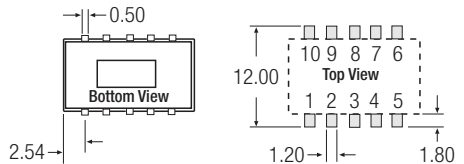

R1S** : ** without marking denotes 5 pins out of 8 fitted (includes /H option)
 ** with marking **8** denotes 8 pins out of 8 fitted (/H option not available)

R1D** : ** without marking denotes 6 pins out of 10 fitted (includes /H option)
 ** with marking **10** denotes with 10 pins out of 10 fitted (/H option not available)

e.g. R1S-0505, R1S-0505/H, R1S-0505/HP
 e.g. R1S8-0505, R1S8-0505/P

e.g. R1D-0505, R1D-0505/H, R1D-0505/HP
 e.g. R1D10-0505, R1D10-0505/P

Package Style and Pinning (mm)

12 PIN Single and Dual SMD Package

Note: /H option is available in this pin package

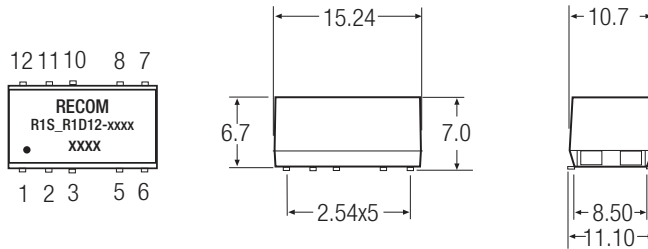

Pin Connections

Pin #	Single	Dual
1	-Vin	-Vin
2	+Vin	+Vin
3	NC	NC
5	-Vout	Com
6	NC	-Vout
7	NC	NC
8	+Vout	+Vout
10	NC	NC
11	NC	NC
12	NC	NC

NC = No Connection

XX.X ± 0.5 mm

XX.XX ± 0.25 mm

Recommended Footprint Details

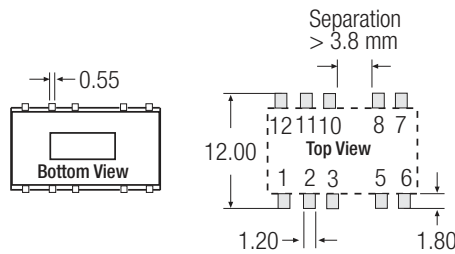

R1S** : ** with marking **12** denotes 10 pins out of 12 fitted (includes /H option)
R1D** : ** with marking **12** denotes 10 pins out of 12 fitted (includes /H option)

e.g. R1S12-0505, R1S12-0505/H, R1S12-0505/HP
e.g. R1D12-0505, R1D12-0505/H, R1D12-0505/HP

EMC Filtering - Suggestion for EN55022 Class B (Conducted and Emitted)

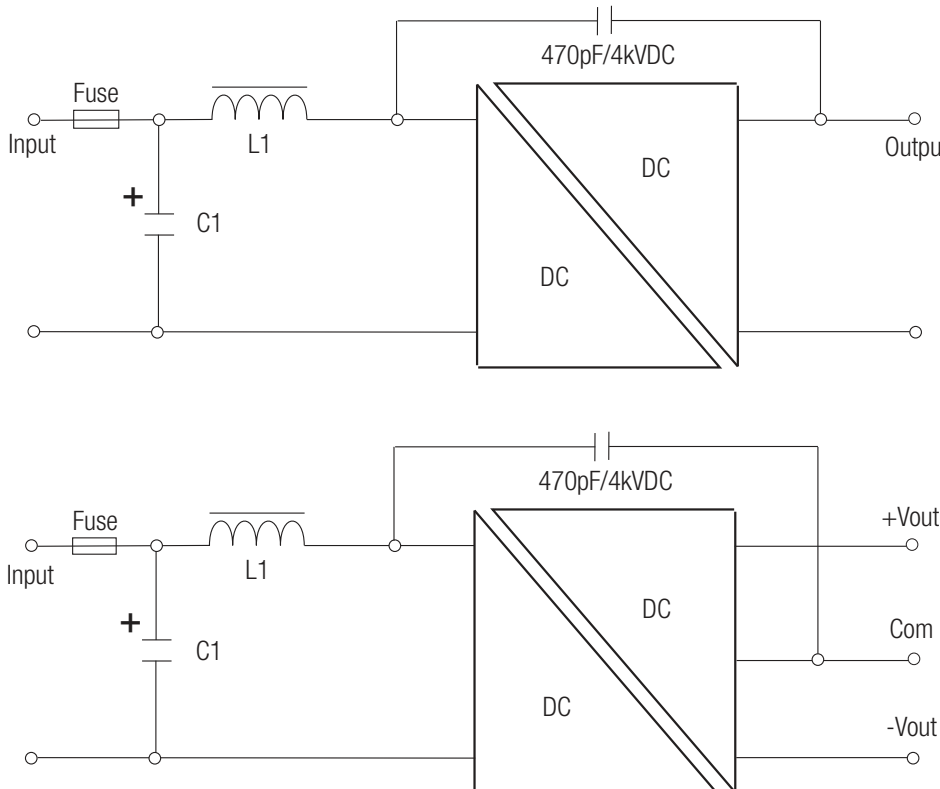

Standard and /H versions

C1	L1	Vin
4.7µF	3.3µH	3.3V
2.2µF	4.7µH	5V
2.2µF	10µH	12V
2.2µF	22µH	15V
4.7µF	22µH	24V

/P and /HP versions

C1	L1	Vin
4.7µF	10µH	3.3V
10µF	10µH	5V
4.7µF	22µH	12V
4.7µF	22µH	15V
10µF	47µH	24V

C1 = MLCC

L1 = SMD Inductor

The product information and specifications are subject to change without prior notice. RECOM products are not authorized for use in safety-critical applications (such as life support) without RECOM's explicit written consent. A safety-critical application is defined as an application where a failure of a RECOM product may reasonably be expected to endanger or cause loss of life, inflict bodily harm or damage property. The buyer shall indemnify and hold harmless RECOM, its affiliated companies and its representatives against any damage claims in connection with the unauthorized use of RECOM products in such safety-critical applications.