

2SC5820

Silicon NPN Epitaxial High Frequency Low Noise Amplifier / Oscillator

R07DS0279EJ0300
(Previous: REJ03G0758-0200)
Rev.3.00
Mar 28, 2011

Application

- High gain bandwidth product
 $f_T = 20 \text{ GHz typ.}$
- High power gain and low noise figure;
 $PG = 17.5 \text{ dB typ.}, NF = 1.15 \text{ dB typ. at } f = 1.8 \text{ GHz}$

Outline

RENESAS Package code: PTSP0004ZA-A
(Package name: CMPAK-4)

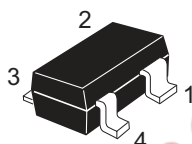

1. Emitter
2. Collector
3. Emitter
4. Base

Note: Marking is "WU-".

Absolute Maximum Ratings

($T_a = 25^\circ\text{C}$)

Item	Symbol	Ratings	Unit
Collector to base voltage	V_{CBO}	12	V
Collector to emitter voltage	V_{CEO}	4.0	V
Emitter to base voltage	V_{EBO}	1.5	V
Collector current	I_c	35	mA
Collector power dissipation	P_c	100	mW
Junction temperature	T_j	150	$^\circ\text{C}$
Storage temperature	T_{stg}	-55 to +150	$^\circ\text{C}$

Electrical Characteristics

(Ta = 25°C)

Item	Symbol	Min	Typ	Max	Unit	Test conditions
Collector cutoff current	I_{CBO}	—	—	1	μA	$V_{CB} = 12\text{ V}, I_E = 0$
Collector cutoff current	I_{CEO}	—	—	1	μA	$V_{CE} = 4\text{ V}, R_{BE} = \infty$
Emitter cutoff current	I_{EBO}	—	—	10	μA	$V_{EB} = 1.5\text{ V}, I_C = 0$
DC current transfer ratio	h_{FE}	70	110	150	—	$V_{CE} = 2\text{ V}, I_C = 20\text{ mA}$
Collector output capacitance	C_{ob}	—	0.3	0.6	pF	$V_{CB} = 2\text{ V}, I_E = 0, f = 1\text{ MHz}$
Gain bandwidth product	f_T	17	20	—	GHz	$V_{CE} = 2\text{ V}, I_C = 30\text{ mA}$ $f = 2\text{ GHz}$
Power gain	PG	13	17.5	—	dB	$V_{CE} = 2\text{ V}, I_C = 30\text{ mA},$ $f = 1.8\text{ GHz}$
Noise figure	NF	—	1.15	1.7	dB	$V_{CE} = 2\text{ V}, I_C = 5\text{ mA},$ $f = 1.8\text{ GHz}$
3rd. Order Intercept Point	IP3	—	10	—	dBm	$V_{CE} = 2\text{ V}, I_C = 5\text{ mA},$ $f = 1.8\text{ GHz}$

Not recommend
for new design

Main Characteristics

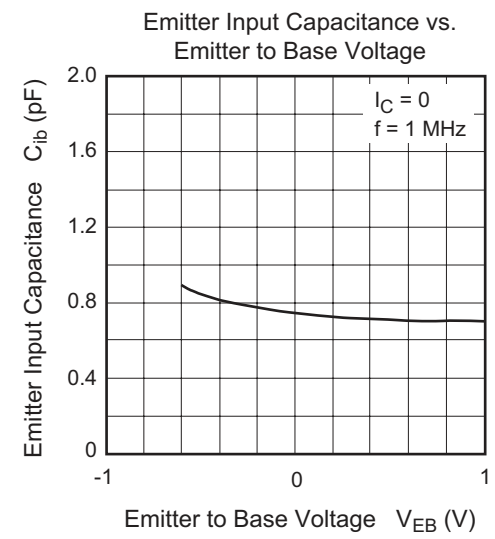
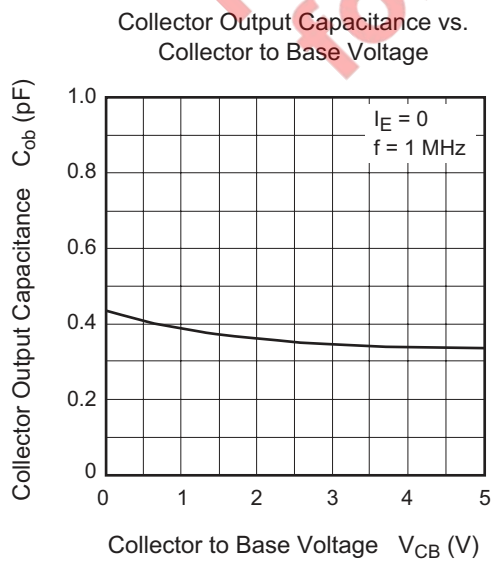
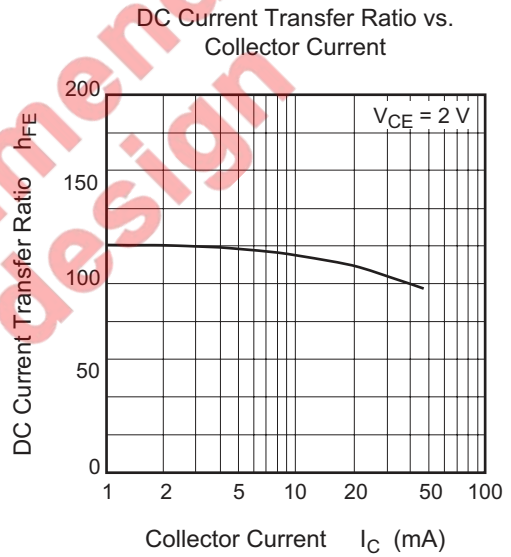
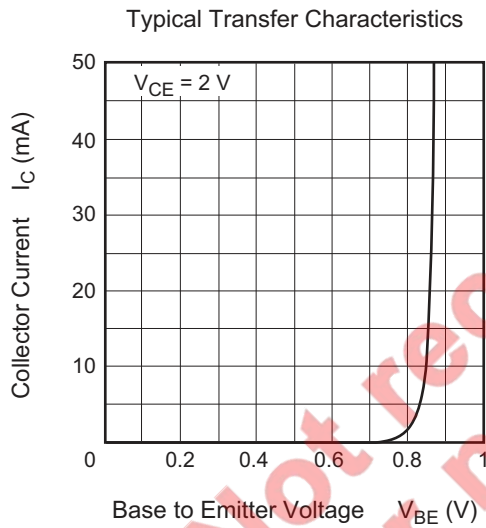
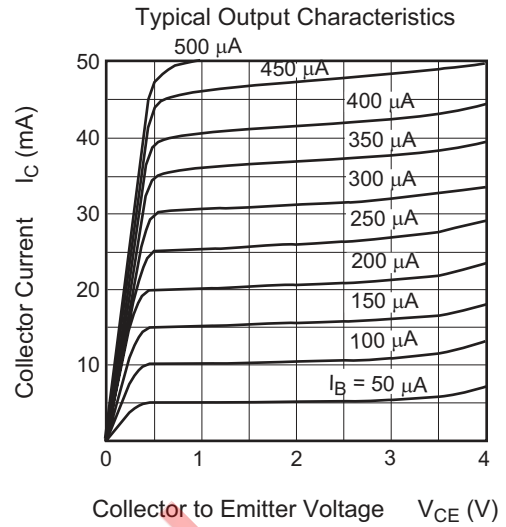
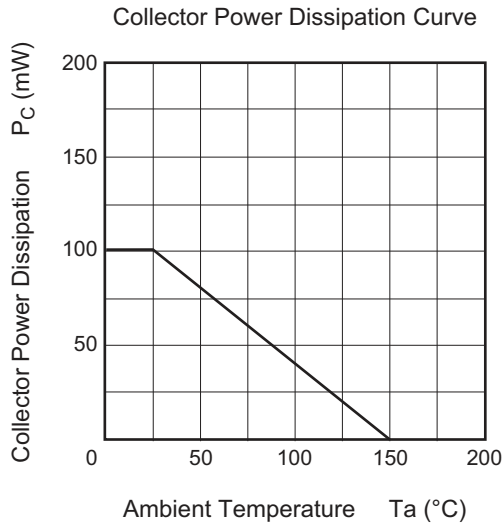

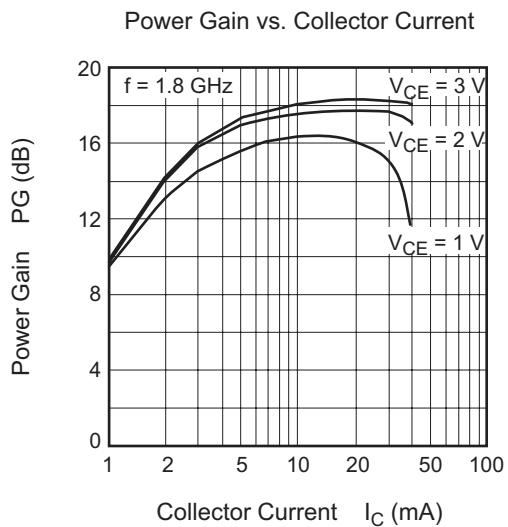
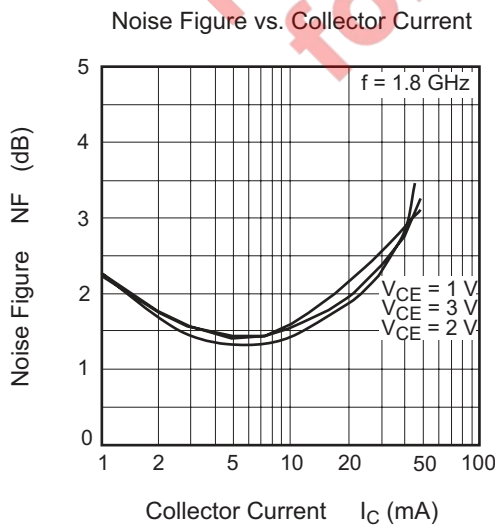
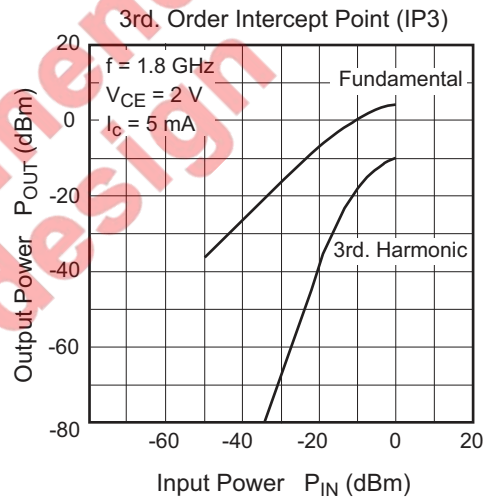
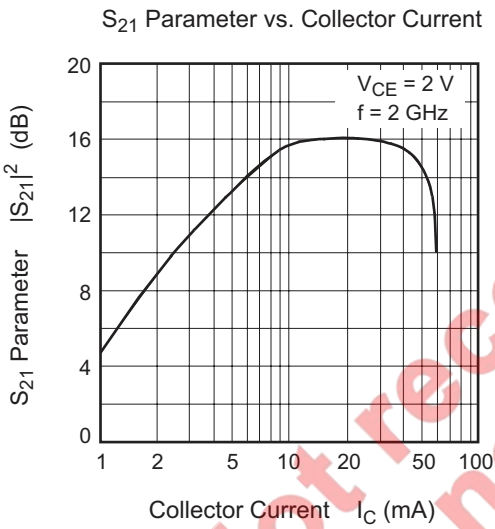
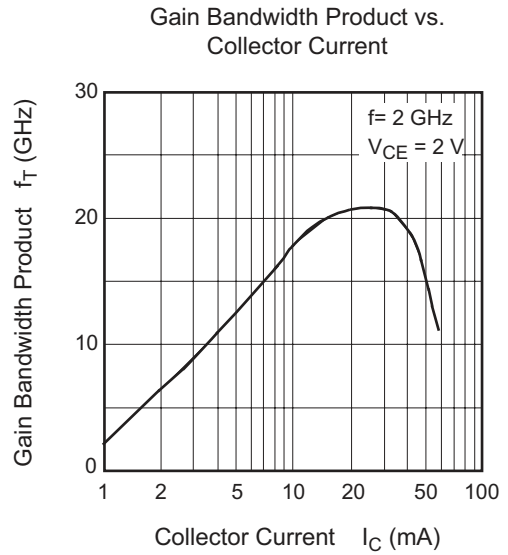
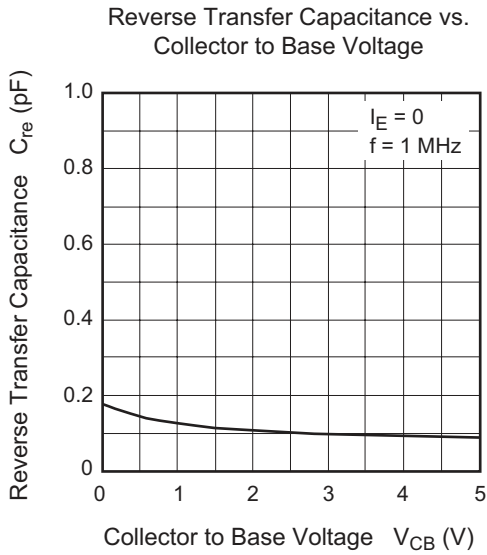

S₁₁ Parameter vs. Frequency

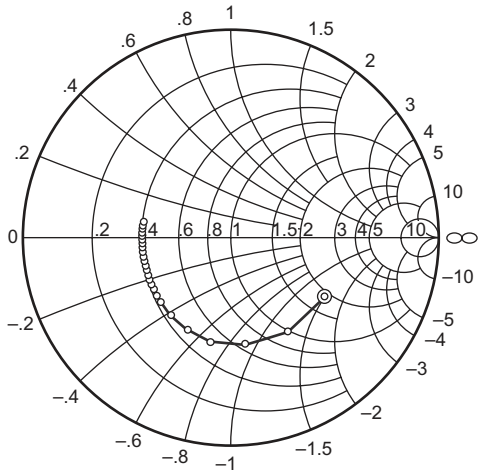

Condition: $V_{CE} = 2\text{ V}$, $Z_O = 50\ \Omega$
 100 to 3000 MHz (100 MHz Step)
 ⊙—○ ($I_C = 30\text{ mA}$)

S₂₁ Parameter vs. Frequency

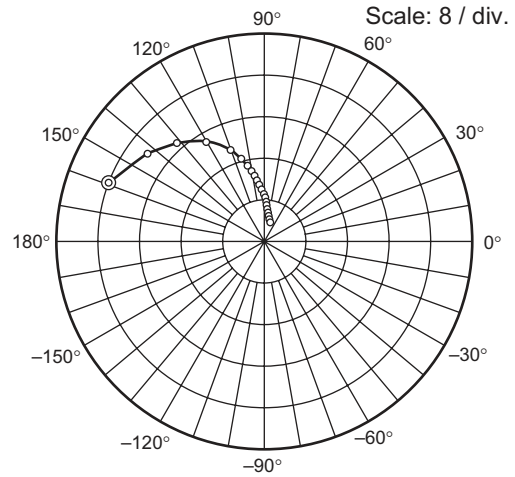

Condition: $V_{CE} = 2\text{ V}$, $Z_O = 50\ \Omega$
 100 to 3000 MHz (100 MHz Step)
 ⊙—○ ($I_C = 30\text{ mA}$)

S₁₂ Parameter vs. Frequency

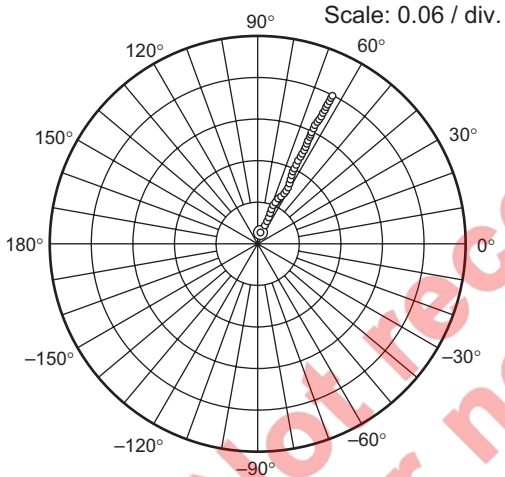

Condition: $V_{CE} = 2\text{ V}$, $Z_O = 50\ \Omega$
 100 to 3000 MHz (100 MHz Step)
 ⊙—○ ($I_C = 30\text{ mA}$)

S₂₂ Parameter vs. Frequency

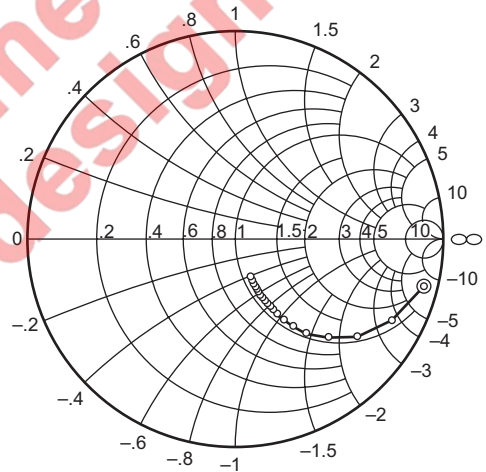

Condition: $V_{CE} = 2\text{ V}$, $Z_O = 50\ \Omega$
 100 to 3000 MHz (100 MHz Step)
 ⊙—○ ($I_C = 30\text{ mA}$)

S Parameter

 $(V_{CE} = 2 \text{ V}, I_C = 5 \text{ mA}, Z_O = 50 \Omega)$

f (MHz)	S11		S21		S12		S22	
	MAG	ANG	MAG	ANG	MAG	ANG	MAG	ANG
100	0.844	-24.6	15.26	159.9	0.0124	78.9	0.976	-16.4
200	0.835	-23.1	15.07	162.9	0.0153	84.0	0.973	-11.7
300	0.838	-34.2	14.59	154.8	0.0236	80.2	0.953	-17.5
400	0.809	-45.7	13.94	147.1	0.0311	72.5	0.919	-23.6
500	0.781	-56.2	13.16	139.9	0.0387	67.5	0.879	-29.0
600	0.745	-66.8	12.39	133.1	0.0441	61.6	0.828	-33.9
700	0.710	-76.0	11.71	127.7	0.0506	56.2	0.779	-38.6
800	0.688	-85.5	10.89	121.8	0.0537	52.0	0.728	-41.9
900	0.659	-93.5	10.16	117.0	0.0579	47.7	0.682	-45.4
1000	0.639	-101.0	9.47	112.8	0.0610	46.8	0.641	-47.4
1100	0.633	-107.3	8.77	108.6	0.0643	41.1	0.601	-49.8
1200	0.596	-115.4	8.40	105.2	0.0640	40.4	0.560	-51.8
1300	0.578	-121.8	7.92	101.5	0.0665	37.6	0.528	-54.0
1400	0.570	-128.0	7.47	98.3	0.0675	37.4	0.499	-55.4
1500	0.556	-133.1	7.04	95.6	0.0685	32.9	0.473	-57.1
1600	0.548	-138.8	6.68	92.5	0.0691	32.9	0.449	-58.0
1700	0.541	-143.6	6.37	90.1	0.0693	32.5	0.422	-59.0
1800	0.532	-149.0	6.08	87.5	0.0699	30.2	0.400	-60.6
1900	0.529	-153.1	5.77	85.0	0.0716	30.6	0.384	-60.7
2000	0.523	-157.1	5.53	83.2	0.0735	28.8	0.370	-62.1
2100	0.520	-162.0	5.29	80.4	0.0719	30.4	0.349	-62.5
2200	0.521	-164.7	5.03	79.1	0.0733	28.1	0.345	-63.6
2300	0.521	-168.8	4.86	76.4	0.0752	26.6	0.326	-64.0
2400	0.521	-172.0	4.67	74.4	0.0748	26.8	0.312	-64.8
2500	0.520	-175.7	4.53	72.3	0.0752	26.8	0.297	-65.6
2600	0.522	-178.4	4.33	70.6	0.0765	26.2	0.292	-66.7
2700	0.525	178.2	4.21	68.6	0.0771	27.6	0.280	-67.8
2800	0.526	175.6	4.05	67.2	0.0775	27.4	0.275	-68.9
2900	0.529	172.4	3.91	64.8	0.0785	25.5	0.260	-69.5
3000	0.532	169.7	3.82	62.7	0.0772	24.6	0.249	-70.5

f (MHz)	S11		S21		S12		S22	
	MAG	ANG	MAG	ANG	MAG	ANG	MAG	ANG
100	0.717	-17.3	25.92	167.8	0.0073	84.9	0.967	-8.4
200	0.712	-34.2	24.87	156.2	0.0137	81.4	0.941	-17.1
300	0.699	-50.1	23.25	145.5	0.0205	73.7	0.896	-25.1
400	0.667	-65.5	21.32	136.0	0.0266	66.0	0.833	-32.8
500	0.635	-78.9	19.27	127.6	0.0319	62.0	0.766	-39.1
600	0.600	-91.5	17.37	120.5	0.0349	56.4	0.694	-44.3
700	0.572	-102.0	15.73	115.1	0.0403	52.7	0.632	-48.6
800	0.553	-112.1	14.26	109.6	0.0402	51.2	0.574	-51.7
900	0.533	-120.1	12.97	105.3	0.0445	46.0	0.525	-54.8
1000	0.522	-127.4	11.90	101.6	0.0472	47.2	0.484	-56.2
1100	0.515	-133.7	10.90	98.1	0.0476	43.4	0.446	-58.4
1200	0.499	-140.9	10.16	95.3	0.0477	44.4	0.410	-59.4
1300	0.492	-146.8	9.46	92.2	0.0505	43.3	0.381	-61.0
1400	0.490	-152.1	8.84	89.6	0.0509	43.8	0.357	-61.9
1500	0.484	-156.6	8.27	87.4	0.0520	39.7	0.335	-62.9
1600	0.484	-161.3	7.79	84.8	0.0533	41.0	0.316	-63.4
1700	0.482	-165.3	7.38	82.8	0.0540	41.4	0.295	-64.0
1800	0.481	-169.8	6.99	80.7	0.0548	40.0	0.277	-65.0
1900	0.481	-173.1	6.63	78.7	0.0578	41.6	0.265	-65.1
2000	0.481	-176.4	6.33	76.9	0.0601	39.9	0.252	-66.1
2100	0.483	179.9	6.02	74.8	0.0603	42.3	0.238	-66.1
2200	0.484	177.3	5.75	73.4	0.0610	39.9	0.232	-66.9
2300	0.488	174.4	5.52	71.4	0.0641	39.3	0.219	-67.2
2400	0.489	171.8	5.29	69.6	0.0646	39.5	0.209	-67.7
2500	0.491	169.0	5.10	67.8	0.0664	40.2	0.197	-68.0
2600	0.495	166.5	4.89	66.2	0.0678	39.7	0.194	-69.7
2700	0.501	164.3	4.73	64.6	0.0693	40.4	0.185	-71.0
2800	0.503	161.9	4.55	63.2	0.0705	40.2	0.181	-71.9
2900	0.508	159.6	4.39	61.4	0.0715	39.5	0.170	-72.9
3000	0.510	157.3	4.27	59.6	0.0717	37.3	0.162	-74.0

f (MHz)	S11		S21		S12		S22	
	MAG	ANG	MAG	ANG	MAG	ANG	MAG	ANG
100	0.556	-26.3	38.68	163.4	0.0065	88.2	0.937	-11.6
200	0.550	-50.8	35.60	148.3	0.0117	78.3	0.882	-23.2
300	0.537	-72.0	31.52	135.5	0.0174	71.3	0.805	-32.9
400	0.519	-90.7	27.37	125.0	0.0215	63.3	0.716	-41.4
500	0.501	-105.4	23.66	116.7	0.0252	62.0	0.633	-47.6
600	0.485	-118.3	20.55	110.2	0.0276	57.0	0.556	-52.3
700	0.475	-128.1	18.10	105.3	0.0310	54.2	0.495	-55.9
800	0.470	-137.3	16.09	100.7	0.0312	54.1	0.441	-58.4
900	0.462	-144.3	14.43	97.1	0.0352	51.7	0.397	-60.8
1000	0.460	-150.4	13.12	94.1	0.0369	53.1	0.362	-61.7
1100	0.460	-155.8	11.95	91.2	0.0389	50.4	0.330	-63.6
1200	0.458	-161.4	11.00	88.9	0.0397	52.5	0.302	-63.5
1300	0.457	-166.3	10.20	86.4	0.0425	51.5	0.280	-64.7
1400	0.460	-170.1	9.48	84.2	0.0441	53.3	0.260	-65.2
1500	0.457	-173.9	8.85	82.2	0.0452	49.4	0.242	-66.3
1600	0.462	-177.4	8.31	80.0	0.0469	50.7	0.227	-65.9
1700	0.462	179.3	7.84	78.4	0.0478	52.0	0.210	-66.4
1800	0.466	175.9	7.41	76.6	0.0496	49.7	0.198	-66.8
1900	0.467	173.3	7.02	74.8	0.0532	51.5	0.187	-67.2
2000	0.469	170.6	6.70	73.2	0.0548	50.1	0.178	-67.2
2100	0.474	167.8	6.36	71.4	0.0572	52.8	0.167	-67.3
2200	0.476	165.5	6.09	70.0	0.0574	50.9	0.161	-68.3
2300	0.480	163.3	5.82	68.3	0.0610	48.6	0.152	-68.2
2400	0.483	161.2	5.58	66.7	0.0616	49.0	0.143	-69.2
2500	0.486	159.0	5.37	65.0	0.0638	49.8	0.135	-69.8
2600	0.490	156.9	5.15	63.4	0.0661	48.6	0.131	-70.8
2700	0.497	155.3	4.97	62.1	0.0699	48.9	0.123	-72.9
2800	0.499	153.1	4.78	60.8	0.0715	49.3	0.122	-74.1
2900	0.505	151.4	4.61	59.2	0.0714	48.0	0.114	-75.4
3000	0.506	149.6	4.48	57.6	0.0713	46.7	0.106	-77.2

f (MHz)	S11		S21		S12		S22	
	MAG	ANG	MAG	ANG	MAG	ANG	MAG	ANG
100	0.441	-34.8	45.76	160.6	0.0061	84.2	0.913	-13.6
200	0.449	-65.1	40.75	143.5	0.0110	78.8	0.838	-26.7
300	0.455	-88.7	34.81	129.9	0.0153	69.4	0.741	-37.1
400	0.455	-107.9	29.32	119.4	0.0185	63.3	0.641	-45.5
500	0.451	-122.1	24.83	111.5	0.0223	61.5	0.558	-51.2
600	0.450	-133.9	21.25	105.6	0.0238	58.6	0.485	-55.6
700	0.449	-142.5	18.53	101.1	0.0280	55.9	0.428	-58.5
800	0.451	-150.6	16.36	97.0	0.0284	57.8	0.378	-60.4
900	0.449	-156.4	14.62	93.7	0.0321	55.5	0.340	-62.8
1000	0.449	-161.7	13.25	91.1	0.0347	57.7	0.308	-63.1
1100	0.453	-166.3	12.05	88.4	0.0360	55.5	0.279	-64.9
1200	0.455	-171.0	11.05	86.3	0.0364	58.0	0.256	-64.1
1300	0.457	-175.0	10.23	84.0	0.0399	56.7	0.236	-65.2
1400	0.460	-178.3	9.50	82.0	0.0413	58.5	0.220	-65.5
1500	0.460	178.5	8.86	80.2	0.0438	54.8	0.204	-66.2
1600	0.466	175.5	8.32	78.1	0.0437	55.1	0.190	-65.9
1700	0.466	172.7	7.84	76.5	0.0465	56.5	0.176	-65.8
1800	0.471	169.8	7.41	74.8	0.0481	55.4	0.165	-66.4
1900	0.472	167.4	7.02	73.2	0.0517	56.0	0.157	-66.9
2000	0.476	165.0	6.69	71.6	0.0540	54.4	0.149	-66.8
2100	0.480	162.7	6.35	69.9	0.0560	56.9	0.139	-67.3
2200	0.483	160.5	6.08	68.5	0.0573	55.2	0.134	-67.8
2300	0.487	158.7	5.81	66.9	0.0604	52.3	0.126	-67.7
2400	0.489	156.8	5.56	65.4	0.0617	53.6	0.117	-68.2
2500	0.493	154.9	5.35	63.8	0.0633	53.4	0.110	-68.8
2600	0.497	153.0	5.14	62.2	0.0659	51.6	0.107	-70.8
2700	0.504	151.6	4.96	60.9	0.0690	52.2	0.101	-72.8
2800	0.507	149.5	4.77	59.6	0.0711	52.9	0.099	-73.4
2900	0.511	148.0	4.59	58.1	0.0714	50.9	0.091	-76.1
3000	0.515	146.3	4.47	56.5	0.0717	49.4	0.085	-78.0

Package Dimensions

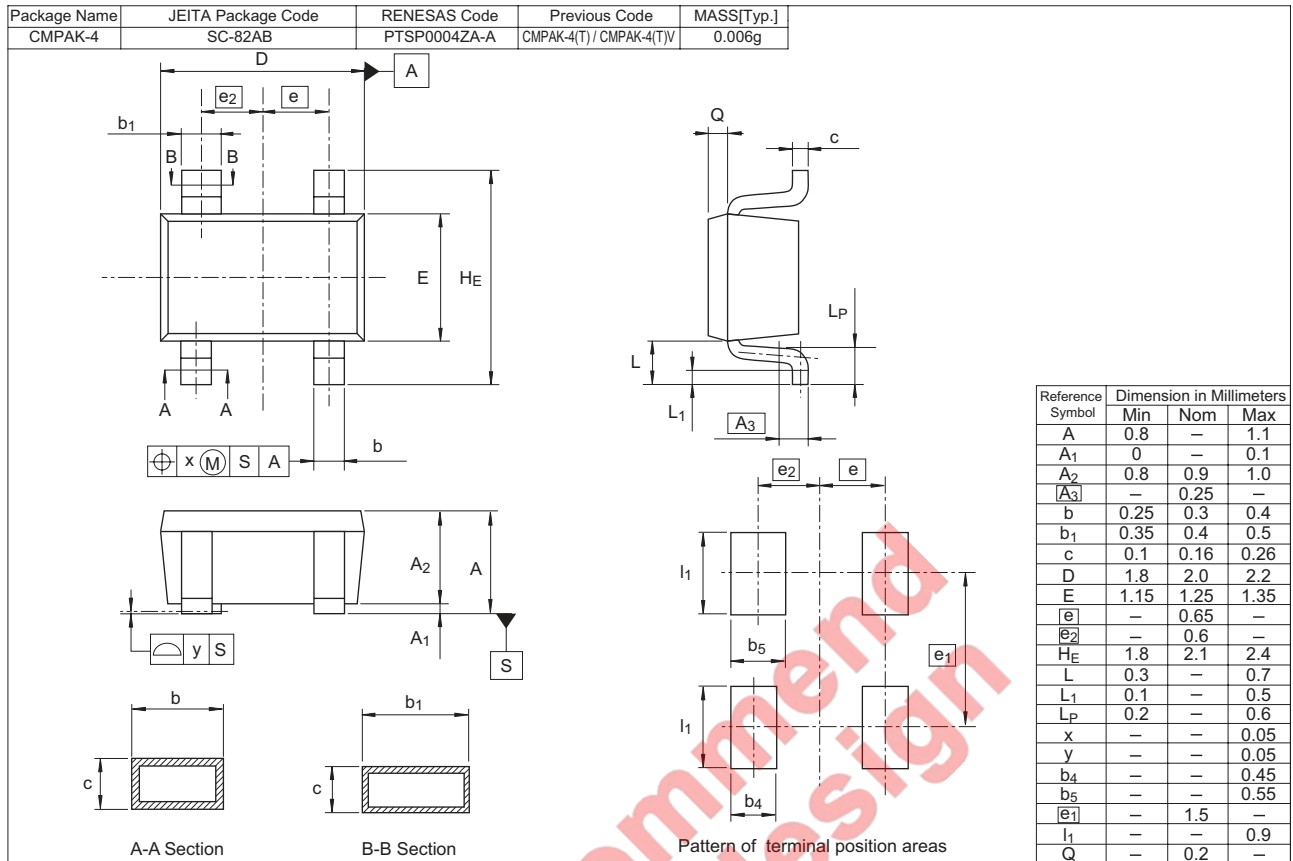

Ordering Information

Orderable Part Number	Quantity	Shipping Container
2SC5820WU-TL-E 2SC5820WU-TL-H	3000	φ 178 mm Reel, 8 mm Emboss Taping

Note: For some grades, production may be terminated. Please contact the Renesas sales office to check the state of production before ordering the product.

Notice

- All information included in this document is current as of the date this document is issued. Such information, however, is subject to change without any prior notice. Before purchasing or using any Renesas Electronics products listed herein, please confirm the latest product information with a Renesas Electronics sales office. Also, please pay regular and careful attention to additional and different information to be disclosed by Renesas Electronics such as that disclosed through our website.
- Renesas Electronics does not assume any liability for infringement of patents, copyrights, or other intellectual property rights of third parties by or arising from the use of Renesas Electronics products or technical information described in this document. No license, express, implied or otherwise, is granted hereby under any patents, copyrights or other intellectual property rights of Renesas Electronics or others.
- You should not alter, modify, copy, or otherwise misappropriate any Renesas Electronics product, whether in whole or in part.
- Descriptions of circuits, software and other related information in this document are provided only to illustrate the operation of semiconductor products and application examples. You are fully responsible for the incorporation of these circuits, software, and information in the design of your equipment. Renesas Electronics assumes no responsibility for any losses incurred by you or third parties arising from the use of these circuits, software, or information.
- When exporting the products or technology described in this document, you should comply with the applicable export control laws and regulations and follow the procedures required by such laws and regulations. You should not use Renesas Electronics products or the technology described in this document for any purpose relating to military applications or use by the military, including but not limited to the development of weapons of mass destruction. Renesas Electronics products and technology may not be used for or incorporated into any products or systems whose manufacture, use, or sale is prohibited under any applicable domestic or foreign laws or regulations.
- Renesas Electronics has used reasonable care in preparing the information included in this document, but Renesas Electronics does not warrant that such information is error free. Renesas Electronics assumes no liability whatsoever for any damages incurred by you resulting from errors in or omissions from the information included herein.
- Renesas Electronics products are classified according to the following three quality grades: "Standard", "High Quality", and "Specific". The recommended applications for each Renesas Electronics product depends on the product's quality grade, as indicated below. You must check the quality grade of each Renesas Electronics product before using it in a particular application. You may not use any Renesas Electronics product for any application categorized as "Specific" without the prior written consent of Renesas Electronics. Further, you may not use any Renesas Electronics product for any application for which it is not intended without the prior written consent of Renesas Electronics. Renesas Electronics shall not be in any way liable for any damages or losses incurred by you or third parties arising from the use of any Renesas Electronics product for an application categorized as "Specific" or for which the product is not intended where you have failed to obtain the prior written consent of Renesas Electronics. The quality grade of each Renesas Electronics product is "Standard" unless otherwise expressly specified in a Renesas Electronics data sheets or data books, etc.
Standard: Computers; office equipment; communications equipment; test and measurement equipment; audio and visual equipment; home electronic appliances; machine tools; personal electronic equipment; and industrial robots.
High Quality: Transportation equipment (automobiles, trains, ships, etc.); traffic control systems; anti-disaster systems; anti-crime systems; safety equipment; and medical equipment not specifically designed for life support.
Specific: Aircraft; aerospace equipment; submersible repeaters; nuclear reactor control systems; medical equipment or systems for life support (e.g. artificial life support devices or systems), surgical implantations, or healthcare intervention (e.g. excision, etc.), and any other applications or purposes that pose a direct threat to human life.
- You should use the Renesas Electronics products described in this document within the range specified by Renesas Electronics, especially with respect to the maximum rating, operating supply voltage range, movement power voltage range, heat radiation characteristics, installation and other product characteristics. Renesas Electronics shall have no liability for malfunctions or damages arising out of the use of Renesas Electronics products beyond such specified ranges.
- Although Renesas Electronics endeavors to improve the quality and reliability of its products, semiconductor products have specific characteristics such as the occurrence of failure at a certain rate and malfunctions under certain use conditions. Further, Renesas Electronics products are not subject to radiation resistance design. Please be sure to implement safety measures to guard them against the possibility of physical injury, and injury or damage caused by fire in the event of the failure of a Renesas Electronics product, such as safety design for hardware and software including but not limited to redundancy, fire control and malfunction prevention, appropriate treatment for aging degradation or any other appropriate measures. Because the evaluation of microcomputer software alone is very difficult, please evaluate the safety of the final products or system manufactured by you.
- Please contact a Renesas Electronics sales office for details as to environmental matters such as the environmental compatibility of each Renesas Electronics product. Please use Renesas Electronics products in compliance with all applicable laws and regulations that regulate the inclusion or use of controlled substances, including without limitation, the EU RoHS Directive. Renesas Electronics assumes no liability for damages or losses occurring as a result of your noncompliance with applicable laws and regulations.
- This document may not be reproduced or duplicated, in any form, in whole or in part, without prior written consent of Renesas Electronics.
- Please contact a Renesas Electronics sales office if you have any questions regarding the information contained in this document or Renesas Electronics products, or if you have any other inquiries.
(Note 1) "Renesas Electronics" as used in this document means Renesas Electronics Corporation and also includes its majority-owned subsidiaries.
(Note 2) "Renesas Electronics product(s)" means any product developed or manufactured by or for Renesas Electronics.



SALES OFFICES

Renesas Electronics Corporation

<http://www.renesas.com>

Refer to "<http://www.renesas.com/>" for the latest and detailed information.

Renesas Electronics America Inc.

2880 Scott Boulevard Santa Clara, CA 95050-2554, U.S.A.
Tel: +1-408-588-6000, Fax: +1-408-588-6130

Renesas Electronics Canada Limited

1101 Nicholson Road, Newmarket, Ontario L3Y 9C3, Canada
Tel: +1-905-898-5441, Fax: +1-905-898-3220

Renesas Electronics Europe Limited

Dukes Meadow, Millboard Road, Bourne End, Buckinghamshire, SL8 5FH, U.K.
Tel: +44-1628-585-100, Fax: +44-1628-585-900

Renesas Electronics Europe GmbH

Arcadiastrasse 10, 40472 Düsseldorf, Germany
Tel: +49-211-65030, Fax: +49-211-6503-1327

Renesas Electronics (China) Co., Ltd.

7th Floor, Quantum Plaza, No.27 ZhiChunLu Haidian District, Beijing 100083, P.R.China
Tel: +86-10-8235-1155, Fax: +86-10-8235-7679

Renesas Electronics (Shanghai) Co., Ltd.

Unit 204, 205, AZIA Center, No.1233 Lujiazui Ring Rd., Pudong District, Shanghai 200120, China
Tel: +86-21-5877-1818, Fax: +86-21-6887-7858 / -7898

Renesas Electronics Hong Kong Limited

Unit 1601-1613, 16/F., Tower 2, Grand Century Place, 193 Prince Edward Road West, Mongkok, Kowloon, Hong Kong
Tel: +852-2886-9318, Fax: +852 2886-9022/9044

Renesas Electronics Taiwan Co., Ltd.

13F, No. 363, Fu Shing North Road, Taipei, Taiwan
Tel: +886-2-8175-9600, Fax: +886 2-8175-9670

Renesas Electronics Singapore Pte. Ltd.

1 HarbourFront Avenue, #06-10, Keppel Bay Tower, Singapore 098632
Tel: +65-6213-0200, Fax: +65-6276-8001

Renesas Electronics Malaysia Sdn.Bhd.

Unit 906, Block B, Menara Amcorp, Amcorp Trade Centre, No. 18, Jln Persiaran Barat, 46050 Petaling Jaya, Selangor Darul Ehsan, Malaysia
Tel: +60-3-7955-9390, Fax: +60-3-7955-9510

Renesas Electronics Korea Co., Ltd.

11F., Samik Lavied' or Bldg., 720-2 Yeoksam-Dong, Kangnam-Ku, Seoul 135-080, Korea
Tel: +82-2-558-3737, Fax: +82-2-558-5141

Notice

- All information included in this document is current as of the date this document is issued. Such information, however, is subject to change without any prior notice. Before purchasing or using any Renesas Electronics products listed herein, please confirm the latest product information with a Renesas Electronics sales office. Also, please pay regular and careful attention to additional and different information to be disclosed by Renesas Electronics such as that disclosed through our website.
- Renesas Electronics does not assume any liability for infringement of patents, copyrights, or other intellectual property rights of third parties by or arising from the use of Renesas Electronics products or technical information described in this document. No license, express, implied or otherwise, is granted hereby under any patents, copyrights or other intellectual property rights of Renesas Electronics or others.
- You should not alter, modify, copy, or otherwise misappropriate any Renesas Electronics product, whether in whole or in part.
- Descriptions of circuits, software and other related information in this document are provided only to illustrate the operation of semiconductor products and application examples. You are fully responsible for the incorporation of these circuits, software, and information in the design of your equipment. Renesas Electronics assumes no responsibility for any losses incurred by you or third parties arising from the use of these circuits, software, or information.
- When exporting the products or technology described in this document, you should comply with the applicable export control laws and regulations and follow the procedures required by such laws and regulations. You should not use Renesas Electronics products or the technology described in this document for any purpose relating to military applications or use by the military, including but not limited to the development of weapons of mass destruction. Renesas Electronics products and technology may not be used for or incorporated into any products or systems whose manufacture, use, or sale is prohibited under any applicable domestic or foreign laws or regulations.
- Renesas Electronics has used reasonable care in preparing the information included in this document, but Renesas Electronics does not warrant that such information is error free. Renesas Electronics assumes no liability whatsoever for any damages incurred by you resulting from errors in or omissions from the information included herein.
- Renesas Electronics products are classified according to the following three quality grades: "Standard", "High Quality", and "Specific". The recommended applications for each Renesas Electronics product depends on the product's quality grade, as indicated below. You must check the quality grade of each Renesas Electronics product before using it in a particular application. You may not use any Renesas Electronics product for any application categorized as "Specific" without the prior written consent of Renesas Electronics. Further, you may not use any Renesas Electronics product for any application for which it is not intended without the prior written consent of Renesas Electronics. Renesas Electronics shall not be in any way liable for any damages or losses incurred by you or third parties arising from the use of any Renesas Electronics product for an application categorized as "Specific" or for which the product is not intended where you have failed to obtain the prior written consent of Renesas Electronics. The quality grade of each Renesas Electronics product is "Standard" unless otherwise expressly specified in a Renesas Electronics data sheets or data books, etc.
"Standard": Computers; office equipment; communications equipment; test and measurement equipment; audio and visual equipment; home electronic appliances; machine tools; personal electronic equipment; and industrial robots.
"High Quality": Transportation equipment (automobiles, trains, ships, etc.); traffic control systems; anti-disaster systems; anti-crime systems; safety equipment; and medical equipment not specifically designed for life support.
"Specific": Aircraft; aerospace equipment; submersible repeaters; nuclear reactor control systems; medical equipment or systems for life support (e.g. artificial life support devices or systems), surgical implantations, or healthcare intervention (e.g. excision, etc.), and any other applications or purposes that pose a direct threat to human life.
- You should use the Renesas Electronics products described in this document within the range specified by Renesas Electronics, especially with respect to the maximum rating, operating supply voltage range, movement power voltage range, heat radiation characteristics, installation and other product characteristics. Renesas Electronics shall have no liability for malfunctions or damages arising out of the use of Renesas Electronics products beyond such specified ranges.
- Although Renesas Electronics endeavors to improve the quality and reliability of its products, semiconductor products have specific characteristics such as the occurrence of failure at a certain rate and malfunctions under certain use conditions. Further, Renesas Electronics products are not subject to radiation resistance design. Please be sure to implement safety measures to guard them against the possibility of physical injury, and injury or damage caused by fire in the event of the failure of a Renesas Electronics product, such as safety design for hardware and software including but not limited to redundancy, fire control and malfunction prevention, appropriate treatment for aging degradation or any other appropriate measures. Because the evaluation of microcomputer software alone is very difficult, please evaluate the safety of the final products or system manufactured by you.
- Please contact a Renesas Electronics sales office for details as to environmental matters such as the environmental compatibility of each Renesas Electronics product. Please use Renesas Electronics products in compliance with all applicable laws and regulations that regulate the inclusion or use of controlled substances, including without limitation, the EU RoHS Directive. Renesas Electronics assumes no liability for damages or losses occurring as a result of your noncompliance with applicable laws and regulations.
- This document may not be reproduced or duplicated, in any form, in whole or in part, without prior written consent of Renesas Electronics.
- Please contact a Renesas Electronics sales office if you have any questions regarding the information contained in this document or Renesas Electronics products, or if you have any other inquiries.
(Note 1) "Renesas Electronics" as used in this document means Renesas Electronics Corporation and also includes its majority-owned subsidiaries.
(Note 2) "Renesas Electronics product(s)" means any product developed or manufactured by or for Renesas Electronics.



SALES OFFICES

Renesas Electronics Corporation

<http://www.renesas.com>

Refer to "<http://www.renesas.com/>" for the latest and detailed information.

Renesas Electronics America Inc.
2880 Scott Boulevard Santa Clara, CA 95050-2554, U.S.A.
Tel: +1-408-588-6000, Fax: +1-408-588-6130

Renesas Electronics Canada Limited
1101 Nicholson Road, Newmarket, Ontario L3Y 9C3, Canada
Tel: +1-905-898-5441, Fax: +1-905-898-3220

Renesas Electronics Europe Limited
Dukes Meadow, Millboard Road, Bourne End, Buckinghamshire, SL8 5FH, U.K
Tel: +44-1628-585-100, Fax: +44-1628-585-900

Renesas Electronics Europe GmbH
Arcadiastrasse 10, 40472 Düsseldorf, Germany
Tel: +49-211-65030, Fax: +49-211-6503-1327

Renesas Electronics (China) Co., Ltd.
7th Floor, Quantum Plaza, No.27 ZhiChunLu Haidian District, Beijing 100083, P.R.China
Tel: +86-10-8235-1155, Fax: +86-10-8235-7679

Renesas Electronics (Shanghai) Co., Ltd.
Unit 204, 205, AZIA Center, No.1233 Lujiazui Ring Rd., Pudong District, Shanghai 200120, China
Tel: +86-21-5877-1818, Fax: +86-21-6887-7858 / -7898

Renesas Electronics Hong Kong Limited
Unit 1601-1613, 16/F., Tower 2, Grand Century Place, 193 Prince Edward Road West, Mongkok, Kowloon, Hong Kong
Tel: +852-2886-9318, Fax: +852 2886-9022/9044

Renesas Electronics Taiwan Co., Ltd.
13F, No. 363, Fu Shing North Road, Taipei, Taiwan
Tel: +886-2-8175-9600, Fax: +886 2-8175-9670

Renesas Electronics Singapore Pte. Ltd.
1 HarbourFront Avenue, #06-10, Keppel Bay Tower, Singapore 098632
Tel: +65-6213-0200, Fax: +65-6278-8001

Renesas Electronics Malaysia Sdn.Bhd.
Unit 906, Block B, Menara Amcorp, Amcorp Trade Centre, No. 18, Jln Persiaran Barat, 46050 Petaling Jaya, Selangor Darul Ehsan, Malaysia
Tel: +60-3-7955-9390, Fax: +60-3-7955-9510

Renesas Electronics Korea Co., Ltd.
11F., Samik Lavied' or Bldg., 720-2 Yeoksam-Dong, Kangnam-Ku, Seoul 135-080, Korea
Tel: +82-2-558-3737, Fax: +82-2-558-5141