

PAGE 1/2

ISSUE 22-03-22

SERIE : SPnT

PART NUMBER : R574413500

## RF CHARACTERISTICS

Number of ways : 5  
Frequency range : 0 - 18 GHz  
Impedance : 50 Ohms

Frequency (GHz)	DC - 3	3 - 8	8 - 12.4	12.4 - 18
VSWR max	1,20	1,30	1,40	1,50
Insertion loss max	0.20 dB	0.30 dB	0.40 dB	0.50 dB
Isolation min	80 dB	70 dB	60 dB	60 dB
Average power (*)	240 W	150 W	120 W	100 W

TERMINATION IMPEDANCE : 50 Ohms  
TERM. AVG. POWER AT 25° C : 1 W per termination / 3 W total power

## ELECTRICAL CHARACTERISTICS

Actuator : NORMALLY OPEN  
Nominal current \*\* : 102 mA  
Actuator voltage (Vcc) : 28V (24 to 30V) / NEGATIVE COMMON  
Terminals : solder pins (250°C max. / 30 sec.)  
Indicator rating : 1 W / 30 V / 100 mA

## MECHANICAL CHARACTERISTICS

Connectors : SMA female per MIL-C 39012  
Life : 2 million cycles per position  
Switching Time\*\*\* : < 15 ms  
Construction : Splashproof  
Weight : < 250 g

## ENVIRONMENTAL CHARACTERISTICS

Operating temperature range : -40°C to +85°C  
Storage temperature range : -55°C to +85°C

(\* Average power at 25°C per RF Path)  
(\*\* At 25° C ±10%)  
(\*\*\* Nominal voltage ; 25° C)



PAGE 2/2

ISSUE 22-03-22

SERIE : SPnT

PART NUMBER : R574413500

DRAWING

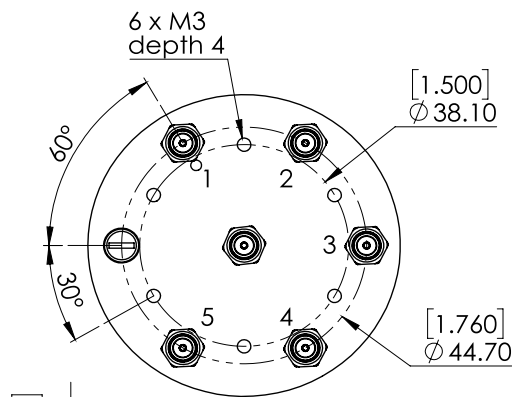

Voltage	RF Continuity	Ind.
-C +1	IN ↔ 1	D.E
-C +2	IN ↔ 2	D.F
-C +3	IN ↔ 3	D.G
-C +4	IN ↔ 4	D.H
-C +5	IN ↔ 5	D.I

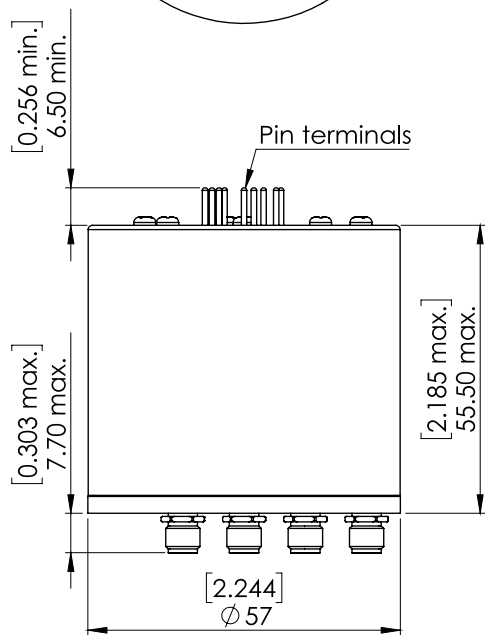

**LABEL**

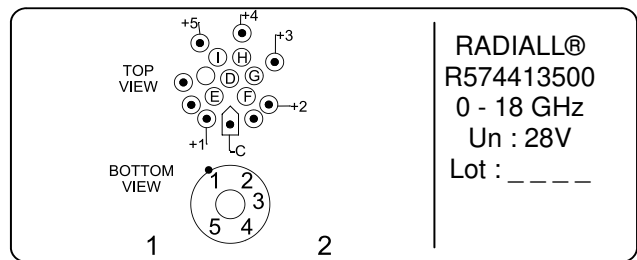

General tolerances : ±0,5 mm [0,02 in]

SCHEMATIC DIAGRAM

