

MCX 50 Ohm Right Angle Crimp Type Plug - Captivated Contact

 INCHES (MILLIMETERS)
 CUSTOMER DRAWINGS AVAILABLE UPON REQUEST

CABLE TYPE	GOLD PLATED	NICKEL PLATED
RG-58/U, 303, 141	133-3407-101	133-3407-106

CABLE GROUP	PART NUMBER	"A"	"B"	"C"	CRIMP HEX
RG-58/u, 303, 141	133-3407-101/106	.067(1.70)	.295 (7.49)	.210 (5.33)	.213 (5.41)

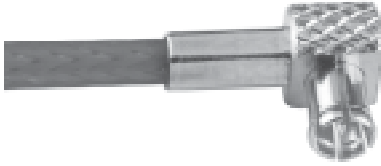
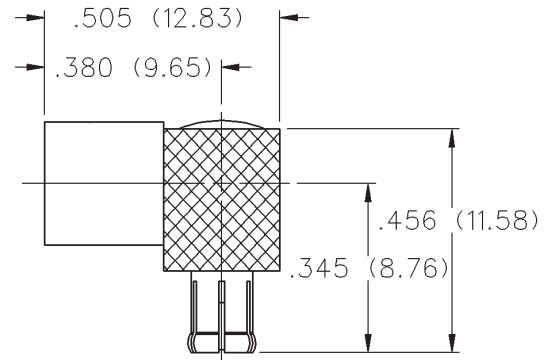
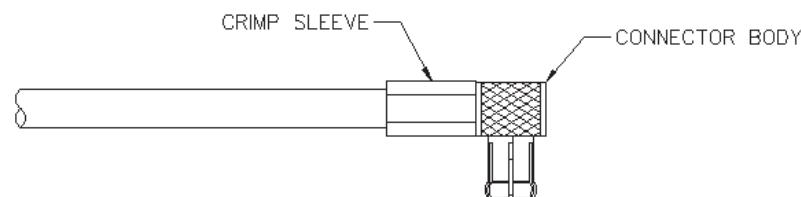
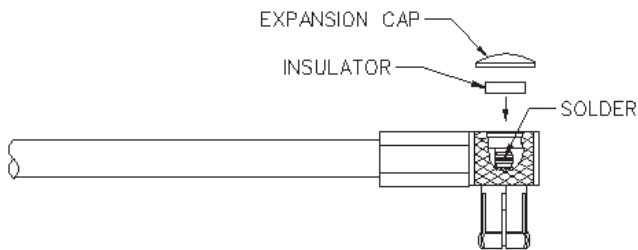
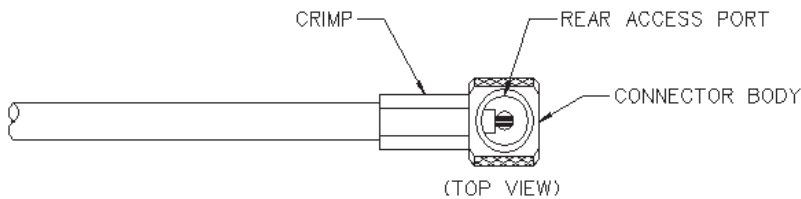
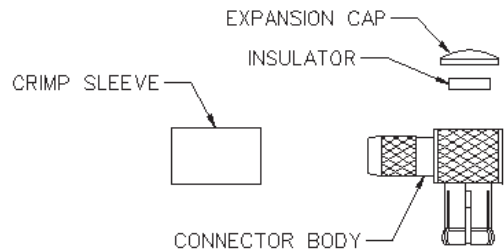
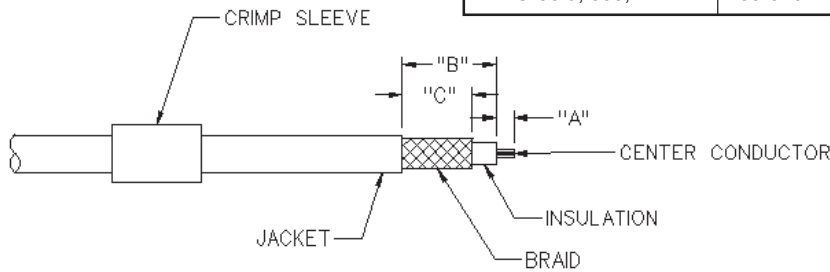

1. Identify connector parts. (4 piece parts except RG-58)
2. Strip cable to dimensions shown. Do not nick braid or center conductor. A wire stripper of correct size is recommended for this step. Twist stranded center conductor into tight bundle and tin (optional). Slide crimp sleeve onto cable shown.
3. Flair braid and slide cable into body making certain that the cable insulation bottoms on center contact. Arrange braid uniformly around crimp stem. Slide crimp sleeve over braid and crimp securely using recommended crimp tool.
4. Solder center conductor to contact through rear access port. Use a minimum amount of solder for a full fillet joint. **.020 (0.51) diameter solder is recommended.**
5. Assemble insulator if applicable then place expansion cap in access port and seat with .156 (3.96) diameter flat punch or MCX hand assembly tool 141-0000-908. Shrink heat shrink tubing over crimp sleeve if applicable.

