

MSP430FE42x Mixed-Signal Microcontrollers

1 Device Overview

1.1 Features

- Low Supply Voltage Range: 2.7 V to 3.6 V
- Ultra-Low Power Consumption:
 - Active Mode: 400 μ A at 1 MHz, 3 V
 - Standby Mode: 1.6 μ A
 - Off Mode (RAM Retention): 0.1 μ A
- Five Power-Saving Modes
- Wake up From Standby Mode in Less Than 6 μ s
- Frequency-Locked Loop, FLL+
- 16-Bit RISC Architecture, 125-ns Instruction Cycle Time
- Embedded Signal Processing for Single-Phase Energy Metering With Integrated Analog Front End and Temperature Sensor (ESP430CE1)
- 16-Bit Timer_A With Three Capture/Compare Registers
- Integrated LCD Driver for 128 Segments
- Serial Communication Interface (USART), Asynchronous UART or Synchronous SPI Selectable by Software
- Brownout Detector
- Supply Voltage Supervisor and Monitor With Programmable Level Detection
- Serial Onboard Programming, No External Programming Voltage Needed, Programmable Code Protection by Security Fuse
- Bootloader (BSL)
- Family Members Include:
 - MSP430FE423
8KB + 256 B of Flash Memory, 256 B of RAM
 - MSP430FE425
16KB + 256 B of Flash Memory, 512 B of RAM
 - MSP430FE427
32KB + 256 B of Flash Memory, 1KB of RAM
- Available in 64-Pin Quad Flat Pack (LQFP)
- For Complete Module Descriptions, See the [MSP430x4xx Family User's Guide](#)

1.2 Applications

- 2-Wire and 3-Wire Single-Phase Meters
- Tamper-Resistant Meters

1.3 Description

The TI MSP430™ family of ultra-low-power microcontrollers consists of several devices featuring different sets of peripherals targeted for various applications. The architecture, combined with five low-power modes, is optimized to achieve extended battery life in portable measurement applications. The device features a powerful 16-bit RISC CPU, 16-bit registers, and constant generators that contribute to maximum code efficiency. The digitally controlled oscillator (DCO) allows the device to wake up from low-power modes to active mode in less than 6 μ s.

The MSP430FE42x series are microcontroller configurations with three independent 16-bit sigma-delta ADCs and an embedded signal processor core used to measure and calculate single-phase energy in both 2-wire and 3-wire configurations. Also included are a built-in 16-bit timer, 128-segment LCD drive capability, and 14 I/O pins.

Typical applications include 2-wire and 3-wire single-phase metering including tamper-resistant meter implementations.



Device Information⁽¹⁾

PART NUMBER	PACKAGE	BODY SIZE ⁽²⁾
MSP430FE427IPM	LQFP (64)	10 mm × 10 mm
MSP430FE425IPM	LQFP (64)	10 mm × 10 mm
MSP430FE423IPM	LQFP (64)	10 mm × 10 mm

(1) For the most current part, package, and ordering information for all available devices, see the *Package Option Addendum* in Section 8, or see the TI website at www.ti.com.

(2) The sizes shown here are approximations. For the package dimensions with tolerances, see the *Mechanical Data* in Section 8.

1.4 Functional Block Diagram

Figure 1-1 shows the functional block diagram.

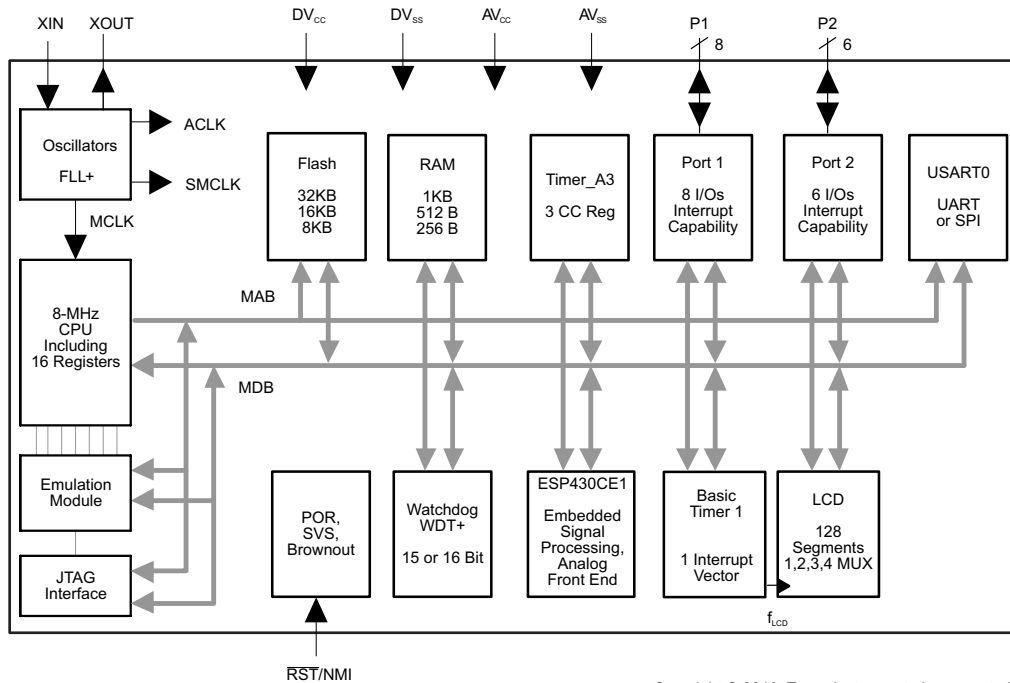

Copyright © 2016, Texas Instruments Incorporated

Figure 1-1. MSP430FE42x Block Diagram

Table of Contents

1	Device Overview	1			
1.1	Features	1	5.25	ESP430CE1, SD16 Reference Output Buffer	24
1.2	Applications	1	5.26	ESP430CE1, SD16 External Reference Input	24
1.3	Description	1	5.27	ESP430CE1, Active Energy Measurement Test Conditions and Accuracy	25
1.4	Functional Block Diagram	2	5.28	ESP430CE1, Active Energy Measurement Test Conditions and Accuracy	25
2	Revision History	4	5.29	ESP430CE1 Typical Characteristics (I1 SD16GAINx = 1)	27
3	Device Comparison	5	5.30	ESP430CE1 Typical Characteristics (I1 SD16GAINx = 4)	28
3.1	Related Products	5	5.31	ESP430CE1 Typical Characteristics (I1 SD16GAINx = 8)	29
4	Terminal Configuration and Functions	6	5.32	ESP430CE1 Typical Characteristics (I1 SD16GAINx = 32)	30
4.1	Pin Diagram	6	5.33	Flash Memory	31
4.2	Signal Descriptions	7	5.34	JTAG Interface	31
5	Specifications	10	5.35	JTAG Fuse	31
5.1	Absolute Maximum Ratings	10	6	Detailed Description	32
5.2	ESD Ratings	10	6.1	CPU	32
5.3	Recommended Operating Conditions	10	6.2	Instruction Set	33
5.4	Supply Current Into AV _{CC} and DV _{CC} Excluding External Current	11	6.3	Operating Modes	34
5.5	Thermal Resistance Characteristics, PM Package (LQFP64)	12	6.4	Interrupt Vector Addresses	35
5.6	Schmitt-Trigger Inputs – Ports (P1 and P2), RST/NMI, JTAG (TCK, TMS, TDI/TCLK, TDO/TDI)	12	6.5	Special Function Registers	36
5.7	Inputs P1.x, P2.x, TAx	12	6.6	Memory Organization	38
5.8	Leakage Current – Ports (P1 and P2)	12	6.7	Bootloader (BSL)	38
5.9	Outputs – Ports (P1 and P2)	13	6.8	Flash Memory	38
5.10	Output Frequency	13	6.9	Peripherals	39
5.11	Typical Characteristics – Ports P1 and P2	14	6.10	Input/Output Diagrams	45
5.12	Wake-up Time From LPM3	15	7	Device and Documentation Support	52
5.13	RAM	15	7.1	Getting Started and Next Steps	52
5.14	LCD	15	7.2	Device Nomenclature	52
5.15	USART0	15	7.3	Tools and Software	54
5.16	POR, BOR	16	7.4	Documentation Support	55
5.17	SVS (Supply Voltage Supervisor and Monitor)	17	7.5	Related Links	57
5.18	DCO	19	7.6	Community Resources	57
5.19	Crystal Oscillator, LFXT1 Oscillator	21	7.7	Trademarks	57
5.20	ESP430CE1, SD16 and ESP430 Power Supply and Operating Conditions	22	7.8	Electrostatic Discharge Caution	57
5.21	ESP430CE1, SD16 Input Range	22	7.9	Export Control Notice	57
5.22	ESP430CE1, SD16 Performance	23	7.10	Glossary	57
5.23	ESP430CE1, SD16 Temperature Sensor	23	8	Mechanical, Packaging, and Orderable Information	58
5.24	ESP430CE1, SD16 Built-in Voltage Reference	24			

2 Revision History

NOTE: Page numbers for previous revisions may differ from page numbers in the current version.

Changes from October 16, 2008 to November 14, 2016	Page
• Format and organization changes throughout document, including addition of section numbering	<u>1</u>
• Added Section 3	<u>5</u>
• Added Section 5 and moved all electrical and timing specifications to it	<u>10</u>
• Added Section 5.2, ESD Ratings	<u>10</u>
• Changed the MAX value of the $I_{(LPM3)}$ parameter at 85°C from 2.6 to 3.5 μ A in Section 5.4, Supply Current Into AV_{CC} and DV_{CC} Excluding External Current	<u>11</u>
• Added Section 5.5, Thermal Resistance Characteristics, PM Package (LQFP-64)	<u>12</u>
• Changed all cases of "bootstrap loader" to "bootloader"	<u>38</u>
• Changed the value of the $\overline{\text{Port}}/\text{LCD}$ column in Table 6-14, Port P1 (P1.2 to P1.7) Pin Functions	<u>46</u>
• Changed the value of the $\overline{\text{Port}}/\text{LCD}$ column in Table 6-15, Port P2 (P2.0 and P2.1) Pin Functions	<u>47</u>
• Added Section 7, Device and Documentation Support	<u>52</u>
• Added Section 8, Mechanical, Packaging, and Orderable Information	<u>58</u>

3 Device Comparison

Table 3-1 summarizes the available family members.

Table 3-1. Device Comparison⁽¹⁾⁽²⁾

DEVICE	FLASH (KB)	RAM (B)	FREQUENCY (MHz)	BSL	ESP430	I/O	PACKAGE
MSP430F427	32	1K	8	UART	1	14	PM 64
MSP430F425	16	512	8	UART	1	14	PM 64
MSP430F423	8	256	8	UART	1	14	PM 64

(1) For the most current package and ordering information, see the *Package Option Addendum* in [Section 8](#), or see the TI website at www.ti.com.

(2) Package drawings, thermal data, and symbolization are available at www.ti.com/packaging.

3.1 Related Products

For information about other devices in this family of products or related products, see the following links.

TI Microcontrollers Product Selection TI's low-power and-high performance MCUs, with wired and wireless connectivity options, are optimized for a broad range of applications.

Products for MSP430 Ultra-Low-Power Microcontrollers One platform. One ecosystem. Endless possibilities. Enabling the connected world with innovations in ultra-low-power microcontrollers with advanced peripherals for precise sensing and measurement.

Products for MSP430F2x/4x Ultra-Low-Power Microcontrollers MSP430F2x/4x microcontrollers (MCUs) from the MSP ultra-low-power MCU series are general-purpose 16-bit microcontrollers used for a wide range of applications including consumer electronics, data logging applications, portable medical instruments, and low-power metering. MSP430F4x MCUs feature an integrated LCD controller, while select MSP430F2x devices feature extended temperature ranges.

Companion Products for MSP430FE427 Review products that are frequently purchased or used with this product.

Reference Designs The TI Designs Reference Design Library is a robust reference design library that spans analog, embedded processor, and connectivity. Created by TI experts to help you jump start your system design, all TI Designs include schematic or block diagrams, BOMs, and design files to speed your time to market.

4 Terminal Configuration and Functions

4.1 Pin Diagram

Figure 4-1 shows the pinout for the 64-pin PM package.

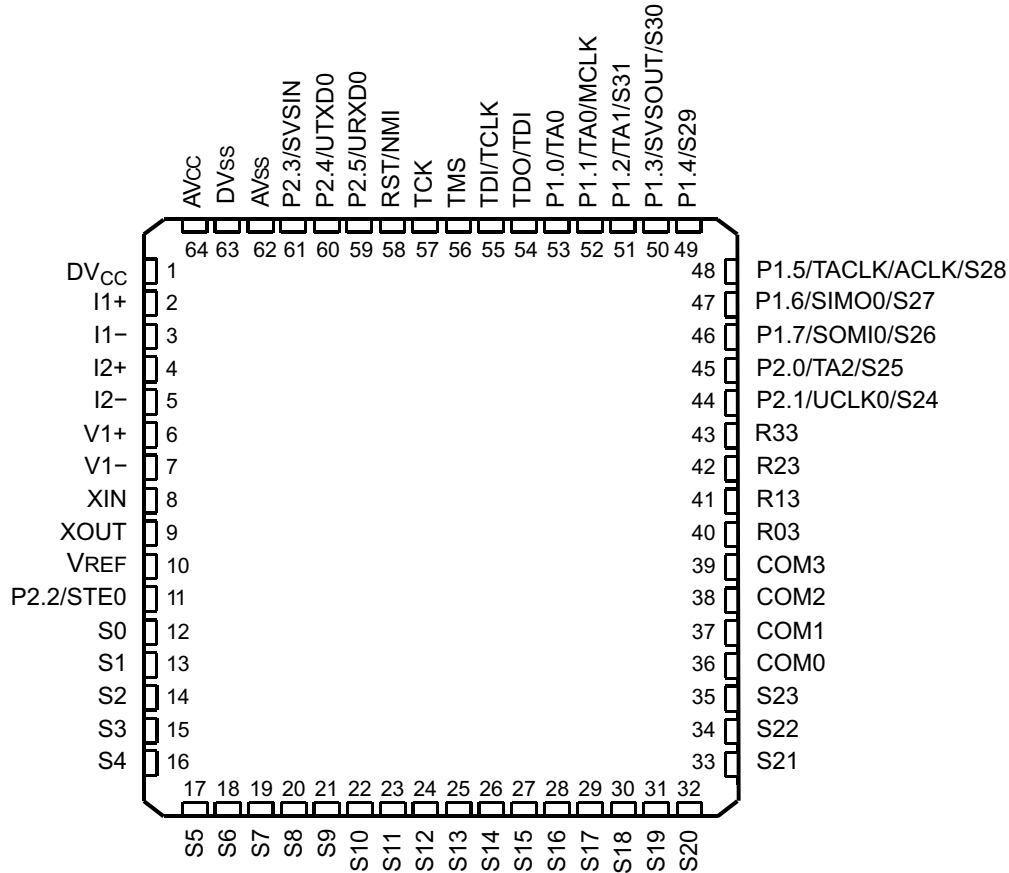

NOTE: TI recommends leaving all unused analog inputs open.

Figure 4-1. 64-Pin PM Package (Top View)

4.2 Signal Descriptions

Table 4-1 describes the signals for all device variants

Table 4-1. Terminal Functions

SIGNAL NAME	PIN NO.	I/O	DESCRIPTION
DVCC	1		Digital supply voltage, positive terminal
I1+	2	I	Current 1 positive analog input, internal connection to SD16 channel 0 A0+ ⁽¹⁾
I1-	3	I	Current 1 negative analog input, internal connection to SD16 channel 0 A0- ⁽¹⁾
I2+	4	I	Current 2 positive analog input, internal connection to SD16 channel 1 A0+ ⁽¹⁾
I2-	5	I	Current 2 negative analog input, internal connection to SD16 channel 1 A0- ⁽¹⁾
V1+	6	I	Voltage 1 positive analog input, internal connection to SD16 channel 2 A0+ ⁽¹⁾
V1-	7	I	Voltage 1 negative analog input, internal connection to SD16 channel 2 A0- ⁽¹⁾
XIN	8	I	Input port for crystal oscillator XT1. Standard or watch crystals can be connected.
XOUT	9	O	Output terminal of crystal oscillator XT1
V _{REF}	10	I/O	Input for an external reference voltage, internal reference voltage output (can be used as mid-voltage)
P2.2/STE0	11	I/O	General-purpose digital I/O Slave transmit enable for USART0 in SPI mode
S0	12	O	LCD segment output 0
S1	13	O	LCD segment output 1
S2	14	O	LCD segment output 2
S3	15	O	LCD segment output 3
S4	16	O	LCD segment output 4
S5	17	O	LCD segment output 5
S6	18	O	LCD segment output 6
S7	19	O	LCD segment output 7
S8	20	O	LCD segment output 8
S9	21	O	LCD segment output 9
S10	22	O	LCD segment output 10
S11	23	O	LCD segment output 11
S12	24	O	LCD segment output 12
S13	25	O	LCD segment output 13
S14	26	O	LCD segment output 14
S15	27	O	LCD segment output 15
S16	28	O	LCD segment output 16
S17	29	O	LCD segment output 17
S18	30	O	LCD segment output 18
S19	31	O	LCD segment output 19
S20	32	O	LCD segment output 20
S21	33	O	LCD segment output 21
S22	34	O	LCD segment output 22
S23	35	O	LCD segment output 23
COM0	36	O	Common output, COM0–COM3 are used for LCD backplanes.
COM1	37	O	Common output, COM0–COM3 are used for LCD backplanes.
COM2	38	O	Common output, COM0–COM3 are used for LCD backplanes.
COM3	39	O	Common output, COM0–COM3 are used for LCD backplanes.
R03	40	I	Input port of fourth positive (lowest) analog LCD level (V5)
R13	41	I	Input port of third most positive analog LCD level (V4 or V3)
R23	42	I	Input port of second most positive analog LCD level (V2)

(1) TI recommends open connection for all unused analog inputs.

Table 4-1. Terminal Functions (continued)

SIGNAL NAME	PIN NO.	I/O	DESCRIPTION
R33	43	O	Output port of most positive analog LCD level (V1)
P2.1/UCLK0/S24	44	I/O	General-purpose digital I/O External clock input for USART0 in UART or SPI mode, or clock output for USART0 in SPI mode LCD segment output 24 ⁽²⁾
P2.0/TA2/S25	45	I/O	General-purpose digital I/O Timer_A Capture: CCI2A input, Compare: Out2 output LCD segment output 25 ⁽²⁾
P1.7/SOMI0/S26	46	I/O	General-purpose digital I/O Slave out/master in for USART0 in SPI mode LCD segment output 26 ⁽²⁾
P1.6/SIMO0/S27	47	I/O	General-purpose digital I/O Slave in/master out for USART0 in SPI mode LCD segment output 27 ⁽²⁾
P1.5/TACLK/ACLK/S28	48	I/O	General-purpose digital I/O Timer_A and SD16 clock signal TACLK input ACLK output (divided by 1, 2, 4, or 8) LCD segment output 28 ⁽²⁾
P1.4/S29	49	I/O	General-purpose digital I/O LCD segment output 29 ⁽²⁾
P1.3/SVSOUT/S30	50	I/O	General-purpose digital I/O SVS: output of SVS comparator LCD segment output 30 ⁽²⁾
P1.2/TA1/S31	51	I/O	General-purpose digital I/O Timer_A, Capture: CCI1A, CCI1B input, Compare: Out1 output LCD segment output 31 ⁽²⁾
P1.1/TA0/MCLK	52	I/O	General-purpose digital I/O Timer_A, Capture: CCI0B input. Note: TA0 is only an input on this pin. MCLK output BSL receive
P1.0/TA0	53	I/O	General-purpose digital I/O Timer_A, Capture: CCI0A input, Compare: Out0 output BSL transmit
TDO/TDI	54	I/O	Test data output port, TDO/TDI data output or programming data input terminal
TDI/TCLK	55	I	Test data input or test clock input. The device protection fuse is connected to TDI.
TMS	56	I	Test mode select. TMS is used as an input port for device programming and test.
TCK	57	I	Test clock. TCK is the clock input port for device programming and test.
RST/NMI	58	I	Reset input or nonmaskable interrupt input port
P2.5/URXD0	59	I/O	General-purpose digital I/O Receive data in for USART0 in UART mode
P2.4/UTXD0	60	I/O	General-purpose digital I/O Transmit data out for USART0 in UART mode

(2) LCD function selected automatically when applicable LCD module control bits are set, not with PxSEL bits.

Table 4-1. Terminal Functions (continued)

SIGNAL NAME	PIN NO.	I/O	DESCRIPTION
P2.3/SVSIN	61	I/O	General-purpose digital I/O Analog input to brownout, supply voltage supervisor
AV _{SS}	62		Analog supply voltage, negative terminal. Supplies SD16, SVS, brownout, oscillator, and LCD resistive divider circuitry.
DV _{SS}	63		Digital supply voltage, negative terminal
AV _{CC}	64		Analog supply voltage, positive terminal. Supplies SD16, SVS, brownout, oscillator, and LCD resistive divider circuitry. Do not power up before DVCC.

5 Specifications

5.1 Absolute Maximum Ratings⁽¹⁾

over operating free-air temperature range (unless otherwise noted)

	MIN	MAX	UNIT	
Voltage applied at V_{CC} to V_{SS}	-0.3	4.1	V	
Voltage applied to any pin ⁽²⁾	-0.3	$V_{CC} + 0.3$	V	
Diode current at any device terminal		±2	mA	
Storage temperature range, T_{stg}	Unprogrammed device	-55	150	°C
	Programmed device	-40	85	

- (1) Stresses beyond those listed under *Absolute Maximum Ratings* may cause permanent damage to the device. These are stress ratings only, and functional operation of the device at these or any other conditions beyond those indicated under *Recommended Operating Conditions* is not implied. Exposure to absolute-maximum-rated conditions for extended periods may affect device reliability.
- (2) All voltages referenced to V_{SS} . The JTAG fuse-blow voltage, V_{FB} , is allowed to exceed the absolute maximum rating. The voltage is applied to the TDI/TCLK pin when blowing the JTAG fuse.

5.2 ESD Ratings

	VALUE	UNIT	
$V_{(ESD)}$ Electrostatic discharge	Human-body model (HBM), per ANSI/ESDA/JEDEC JS-001 ⁽¹⁾	±1000	V
	Charged-device model (CDM), per JEDEC specification JESD22-C101 ⁽²⁾	±250	

- (1) JEDEC document JEP155 states that 500-V HBM allows safe manufacturing with a standard ESD control process. Pins listed as ±1000 V may actually have higher performance.
- (2) JEDEC document JEP157 states that 250-V CDM allows safe manufacturing with a standard ESD control process. Pins listed as ±250 V may actually have higher performance.

5.3 Recommended Operating Conditions

Typical values are specified at $V_{CC} = 3.3$ V and $T_A = 25^\circ\text{C}$ (unless otherwise noted)

	MIN	NOM	MAX	UNIT	
V_{CC} Supply voltage during program execution ⁽¹⁾ ($AV_{CC} = DV_{CC} = V_{CC}$)	ESP430 and SD16 disabled	1.8	3.6	V	
	SVS enabled, PORON = 1 ⁽²⁾ , ESP430 and SD16 disabled	2.0	3.6		
	ESP430 or SD16 enabled or during programming of flash memory	2.7	3.6		
V_{SS} Supply voltage ($AV_{SS} = DV_{SS} = V_{SS}$)	0		0	V	
T_A Operating free-air temperature range	-40		85	°C	
$f_{(LFXT1)}$ LFXT1 crystal frequency ⁽³⁾	LF selected, XTS_FLL = 0	Watch crystal	32.768	kHz	
	XT1 selected, XTS_FLL = 1	Ceramic resonator	450		8000
	XT1 selected, XTS_FLL = 1	Crystal	1000		8000
$f_{(System)}$ Processor frequency (signal MCLK) ⁽⁴⁾ (also see Figure 5-1)	$V_{CC} = 2.7$ V	DC	8.4	MHz	
	$V_{CC} = 3.6$ V	DC	8.4		

- (1) TI recommends powering AV_{CC} and DV_{CC} from the same source. A maximum difference of 0.3 V between AV_{CC} and DV_{CC} can be tolerated during power up and operation.
- (2) The minimum operating supply voltage is defined according to the trip point where POR is going active by decreasing the supply voltage. POR is going inactive when the supply voltage is raised above the minimum supply voltage plus the hysteresis of the SVS circuitry.
- (3) In LF mode, the LFXT1 oscillator requires a watch crystal.
- (4) For frequencies above 8 MHz, MCLK is sourced by the built-in oscillator (DCO and FLL+).

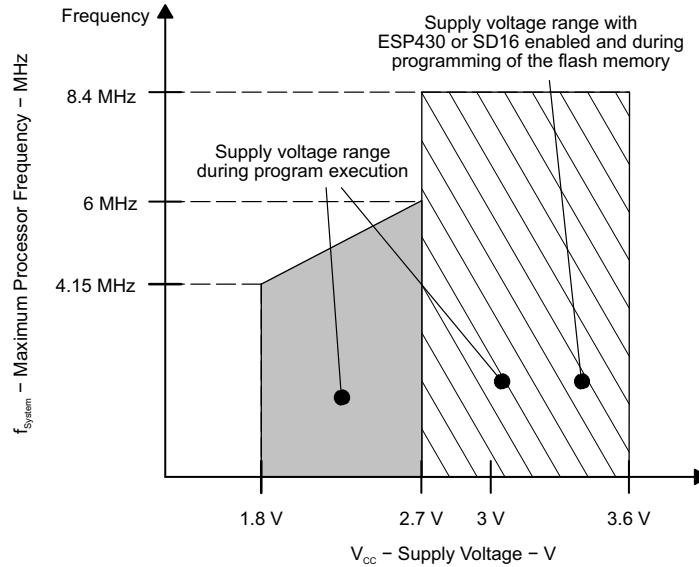

Figure 5-1. Frequency vs Supply Voltage

5.4 Supply Current Into AV_{CC} and DV_{CC} Excluding External Current⁽¹⁾

over recommended operating free-air temperature range (unless otherwise noted)

PARAMETER		T _A	V _{CC}	MIN	TYP	MAX	UNIT
I _(AM)	Active mode (AM) f _(MCLK) = f _(SMCLK) = f _(DCO) = 1 MHz, f _(ACLK) = 32768 Hz, XTS_FLL = 0, program executes in flash	-40°C to 85°C	3 V		400	500	μA
I _(LPM0)	Low-power mode 0 or 1 (LPM0 or LPM1) ⁽²⁾ f _(MCLK) = f _(SMCLK) = f _(DCO) = 1 MHz, f _(ACLK) = 32768 Hz, XTS_FLL = 0, FN_8 = FN_4 = FN_3 = FN_2 = 0	-40°C to 85°C	3 V		130	150	μA
I _(LPM2)	Low-power mode 2 (LPM2) ⁽²⁾	-40°C to 85°C	3 V		10	22	μA
I _(LPM3)	Low-power mode 3 (LPM3) ⁽²⁾	-40°C	3 V		1.5	2.0	μA
		25°C			1.6	2.1	
		60°C			1.7	2.2	
		85°C			2.0	3.5	
I _(LPM4)	Low-power mode 4 (LPM4) ⁽²⁾	-40°C	3 V		0.1	0.5	μA
		25°C			0.1	0.5	
		85°C			0.8	2.5	

(1) All inputs are tied to 0 V or V_{CC}. Outputs do not source or sink any current. The current consumption in LPM2, LPM3, and LPM4 are measured with active Basic Timer1 and LCD (ACLK selected). The current consumption of the ESP430CE1 and the SVS module are specified in their respective sections. LPMx currents measured with WDT+ disabled. The currents are characterized with a KDS Daishinku DT-38 (6 pF) crystal.

(2) Current consumption for brownout is included.

Current consumption of active mode versus system frequency:

$$I_{(AM)} = I_{(AM)} [1 \text{ MHz}] \times f_{(\text{System})} [\text{MHz}]$$

Current consumption of active mode versus supply voltage:

$$I_{(AM)} = I_{(AM)} [3 \text{ V}] + 170 \mu\text{A/V} \times (V_{\text{CC}} - 3 \text{ V})$$

5.5 Thermal Resistance Characteristics, PM Package (LQFP64)

PARAMETER		VALUE	UNIT
$R\theta_{JA}$	Junction-to-ambient thermal resistance, still air ⁽¹⁾	55.7	°C/W
$R\theta_{JC(TOP)}$	Junction-to-case (top) thermal resistance ⁽²⁾	16.7	°C/W
$R\theta_{JB}$	Junction-to-board thermal resistance ⁽³⁾	27.1	°C/W
Ψ_{JB}	Junction-to-board thermal characterization parameter	26.8	°C/W
Ψ_{JT}	Junction-to-top thermal characterization parameter	0.8	°C/W

- (1) The junction-to-ambient thermal resistance under natural convection is obtained in a simulation on a JEDEC-standard, High-K board, as specified in JESD51-7, in an environment described in JESD51-2a.
- (2) The junction-to-case (top) thermal resistance is obtained by simulating a cold plate test on the package top. No specific JEDEC-standard test exists, but a close description can be found in the ANSI SEMI standard G30-88.
- (3) The junction-to-board thermal resistance is obtained by simulating in an environment with a ring cold plate fixture to control the PCB temperature, as described in JESD51-8.

5.6 Schmitt-Trigger Inputs – Ports (P1 and P2), \overline{RST}/NMI , JTAG (TCK, TMS, TDI/TCLK, TDO/TDI)

over recommended operating free-air temperature range (unless otherwise noted)

PARAMETER		V_{CC}	MIN	MAX	UNIT
V_{IT+}	Positive-going input threshold voltage	3 V	1.5	1.98	V
V_{IT-}	Negative-going input threshold voltage	3 V	0.9	1.3	V
V_{hys}	Input voltage hysteresis ($V_{IT+} - V_{IT-}$)	3 V	0.45	1	V

5.7 Inputs P1.x, P2.x, TAX

over recommended operating free-air temperature range (unless otherwise noted)

PARAMETER		TEST CONDITIONS	V_{CC}	MIN	MAX	UNIT
$t_{(int)}$	External interrupt timing	Port P1, P2: P1.x to P2.x, external trigger signal for the interrupt flag ⁽¹⁾	3 V	1.5		cycle
				50		ns
$t_{(cap)}$	Timer_A capture timing	TAx	3 V	50		ns
$f_{(TAext)}$	Timer_A clock frequency externally applied to pin	TAxCLK, INCLK $t_{(H)} = t_{(L)}$	3 V		10	MHz
$f_{(TAint)}$	Timer_A clock frequency	SMCLK or ACLK signal selected	3 V		10	MHz

- (1) The external signal sets the interrupt flag every time the minimum $t_{(int)}$ parameters are met. It may be set even with trigger signals shorter than $t_{(int)}$. Both the cycle and timing specifications must be met to ensure the flag is set. $t_{(int)}$ is measured in MCLK cycles.

5.8 Leakage Current – Ports (P1 and P2)⁽¹⁾

over recommended operating free-air temperature range (unless otherwise noted)

PARAMETER		TEST CONDITIONS	V_{CC}	MIN	MAX	UNIT
$I_{lkg(P1.x)}$	Leakage current, Port P1.x	Port 1: $V_{(P1.x)}$ ⁽²⁾	3 V		±50	nA
$I_{lkg(P2.x)}$	Leakage current, Port P2.x	Port 2: $V_{(P2.x)}$ ⁽²⁾	3 V		±50	nA

- (1) The leakage current is measured with V_{SS} or V_{CC} applied to the corresponding pins, unless otherwise noted.
- (2) The port pin must be selected as input.

5.9 Outputs – Ports (P1 and P2)

over recommended operating free-air temperature range (unless otherwise noted)

PARAMETER		TEST CONDITIONS	V _{CC}	MIN	MAX	UNIT
V _{OH}	High-level output voltage	I _{OH(max)} = –1.5 mA ⁽¹⁾	3 V	V _{CC} – 0.25	V _{CC}	V
		I _{OH(max)} = –6 mA ⁽²⁾	3 V	V _{CC} – 0.6	V _{CC}	
V _{OL}	Low-level output voltage	I _{OL(max)} = 1.5 mA ⁽¹⁾	3 V	V _{SS}	V _{SS} + 0.25	V
		I _{OL(max)} = 6 mA ⁽²⁾	3 V	V _{SS}	V _{SS} + 0.6	

- (1) The maximum total current, I_{OH(max)} and I_{OL(max)}, for all outputs combined, should not exceed ±12 mA to satisfy the maximum specified voltage drop.
- (2) The maximum total current, I_{OH(max)} and I_{OL(max)}, for all outputs combined, should not exceed ±48 mA to satisfy the maximum specified voltage drop.

5.10 Output Frequency

over recommended operating free-air temperature range (unless otherwise noted)

PARAMETER		TEST CONDITIONS	MIN	TYP	MAX	UNIT
f _(P_x.y)	Output frequency (1 ≤ x ≤ 2, 0 ≤ y ≤ 7)	C _L = 20 F, I _L = ±1.5 mA, V _{CC} = 3 V	DC		12	MHz
f _(ACLK) , f _(MCLK) , f _(SMCLK)	P1.1/TA0/MCLK, P1.5/TACLK/ACLK/S28	C _L = 20 pF, V _{CC} = 3 V			12	MHz
t _(Xdc)	Duty cycle of output frequency	P1.5/TACLK/ACLK/S28, C _L = 20 pF, V _{CC} = 3 V	f _{ACLK} = f _{LFXT1} = f _{XT1}	40%	60%	
			f _{ACLK} = f _{LFXT1} = f _{LF}	30%	70%	
		f _{ACLK} = f _{LFXT1}	50%			
		P1.1/TA0/MCLK, C _L = 20 pF, V _{CC} = 3 V, f _{MCLK} = f _{DCOCLK}	50% – 15 ns	50%	50% + 15 ns	

5.11 Typical Characteristics – Ports P1 and P2

Figure 5-2 through Figure 5-5 show the typical output currents of Ports P1 and P2. One output loaded at a time.

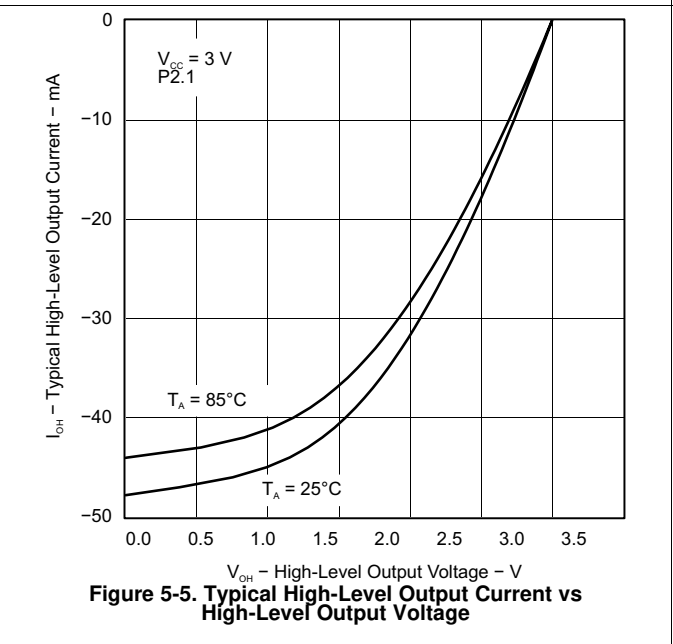
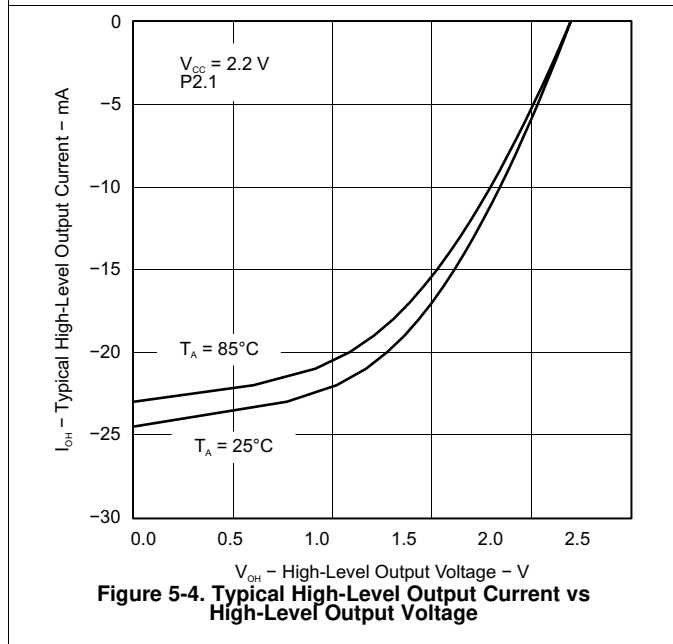
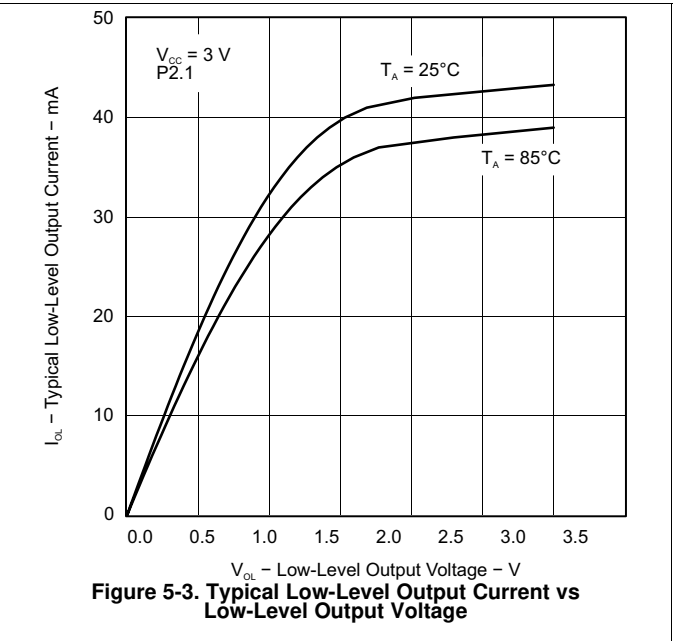
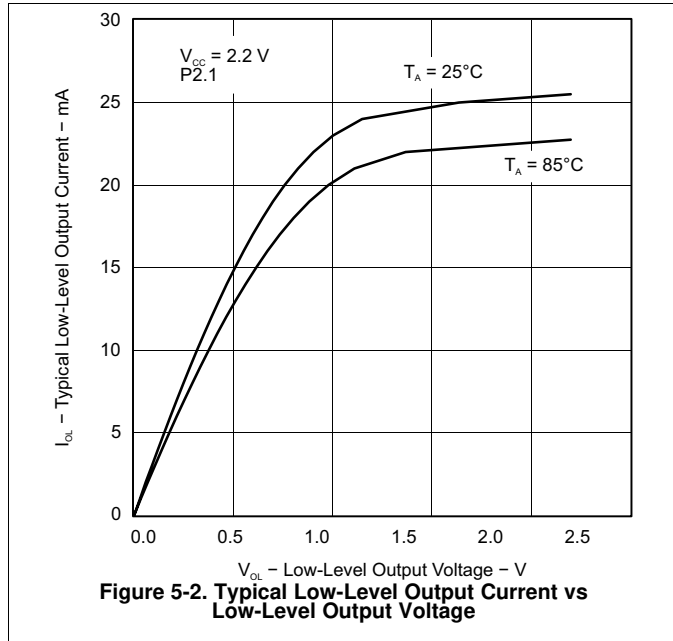

5.12 Wake-up Time From LPM3

over recommended operating free-air temperature range (unless otherwise noted)

PARAMETER		TEST CONDITIONS		MIN	MAX	UNIT
$t_{d(LPM3)}$	Delay time	f = 1 MHz	$V_{CC} = 3\text{ V}$		6	μs
		f = 2 MHz		6		
		f = 3 MHz		6		

5.13 RAM

over recommended operating free-air temperature range (unless otherwise noted)

PARAMETER	TEST CONDITIONS	MIN	MAX	UNIT
V_{RAMh}	CPU halted ⁽¹⁾	1.6		V

- (1) This parameter defines the minimum supply voltage when the data in program memory RAM remain unchanged. No program execution should take place during this supply voltage condition.

5.14 LCD

over recommended operating free-air temperature range (unless otherwise noted)

PARAMETER		TEST CONDITIONS		MIN	TYP	MAX	UNIT
$V_{(33)}$	Analog voltage	Voltage at R33	$V_{CC} = 3\text{ V}$	2.5		$V_{CC} + 0.2$	V
$V_{(23)}$		Voltage at R23		$\frac{[V_{(33)} - V_{(03)}] \times 2}{3 + V_{(03)}}$			
$V_{(13)}$		Voltage at R13		$\frac{[V_{(33)} - V_{(03)}] \times 1}{3 + V_{(03)}}$			
$V_{(33)} - V_{(03)}$		Voltage at R33 to R03		2.5		$V_{CC} + 0.2$	
$I_{(R03)}$	Input leakage	$R03 = V_{SS}$	No load at all segment and common lines, $V_{CC} = 3\text{ V}$			± 20	nA
$I_{(R13)}$		$R13 = V_{CC} / 3$				± 20	
$I_{(R23)}$		$R23 = 2 \times V_{CC} / 3$				± 20	
$V_{(Sxx0)}$	Segment line voltage	$I_{(Sxx)} = -3\ \mu\text{A}, V_{CC} = 3\text{ V}$		$V_{(03)}$		$V_{(03)} - 0.1$	V
$V_{(Sxx1)}$				$V_{(13)}$		$V_{(13)} - 0.1$	
$V_{(Sxx2)}$				$V_{(23)}$		$V_{(23)} - 0.1$	
$V_{(Sxx3)}$				$V_{(33)}$		$V_{(33)} + 0.1$	

5.15 USART0⁽¹⁾

over recommended operating free-air temperature range (unless otherwise noted)

PARAMETER	TEST CONDITIONS	MIN	TYP	MAX	UNIT	
$t_{(\tau)}$	USART0 deglitch time	$V_{CC} = 3\text{ V}, \text{SYNC} = 0, \text{UART mode}$	150	280	500	ns

- (1) The signal applied to the USART0 receive signal/terminal (URXD0) should meet the timing requirements of $t_{(\tau)}$ to ensure that the URXS flip-flop is set. The URXS flip-flop is set with negative pulses meeting the minimum-timing condition of $t_{(\tau)}$. The operating conditions to set the flag must be met independently from this timing constraint. The deglitch circuitry is active only on negative transitions on the URXD0 line.

5.16 POR, BOR⁽¹⁾

over recommended operating free-air temperature range (unless otherwise noted)

PARAMETER	TEST CONDITIONS	MIN	TYP	MAX	UNIT
$t_{d(BOR)}$				2000	μs
$V_{CC(start)}$	$dV_{CC}/dt \leq 3 \text{ V/s}$ (see Figure 5-6)		$0.7 \times V_{(B_IT-)}$		V
$V_{(B_IT-)}$	$dV_{CC}/dt \leq 3 \text{ V/s}$ (see Figure 5-6 through Figure 5-8)		1.71		V
$V_{hys(B_IT-)}$	$dV_{CC}/dt \leq 3 \text{ V/s}$ (see Figure 5-6)	70	130	180	mV
$t_{(reset)}$	Pulse duration needed at $\overline{RST/NMI}$ pin to accept reset internally, $V_{CC} = 3 \text{ V}$	2			μs

- (1) The current consumption of the brownout module is already included in the I_{CC} current consumption data. The voltage level $V_{(B_IT-)} + V_{hys(B_IT-)} \leq 1.8 \text{ V}$.
- (2) During power up, the CPU begins code execution following a period of $t_{d(BOR)}$ after $V_{CC} = V_{(B_IT-)} + V_{hys(B_IT-)}$. The default FLL+ settings must not be changed until $V_{CC} \geq V_{CC(min)}$, where $V_{CC(min)}$ is the minimum supply voltage for the desired operating frequency. See the [MSP430x4xx Family User's Guide](#) for more information on the brownout and SVS circuit.

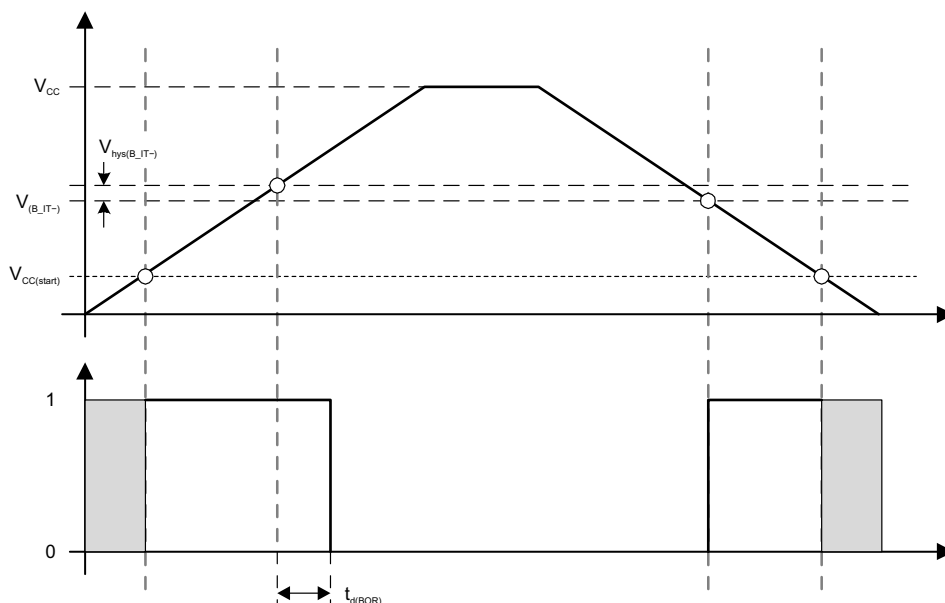

Figure 5-6. POR and BOR vs Supply Voltage

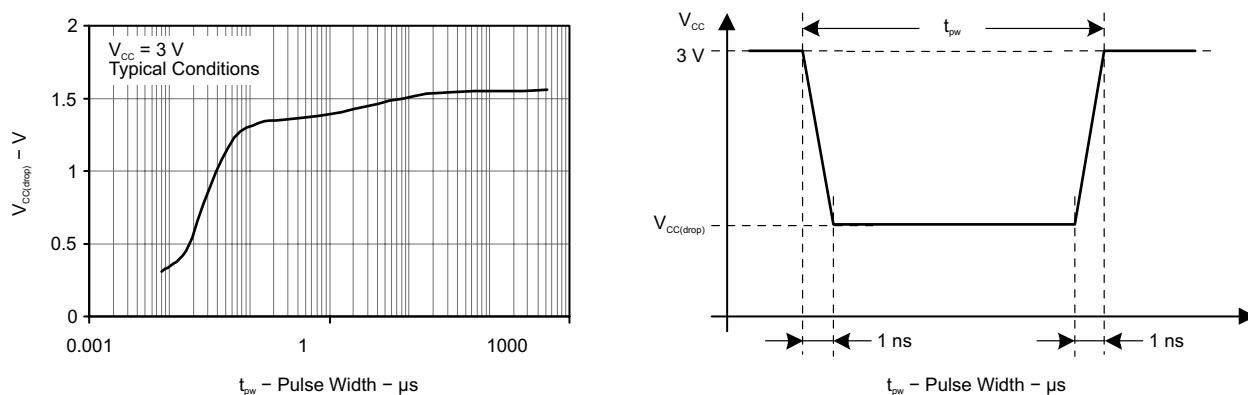

Figure 5-7. $V_{CC(drop)}$ Level With a Rectangular Voltage Drop to Generate a POR/Brownout Signal

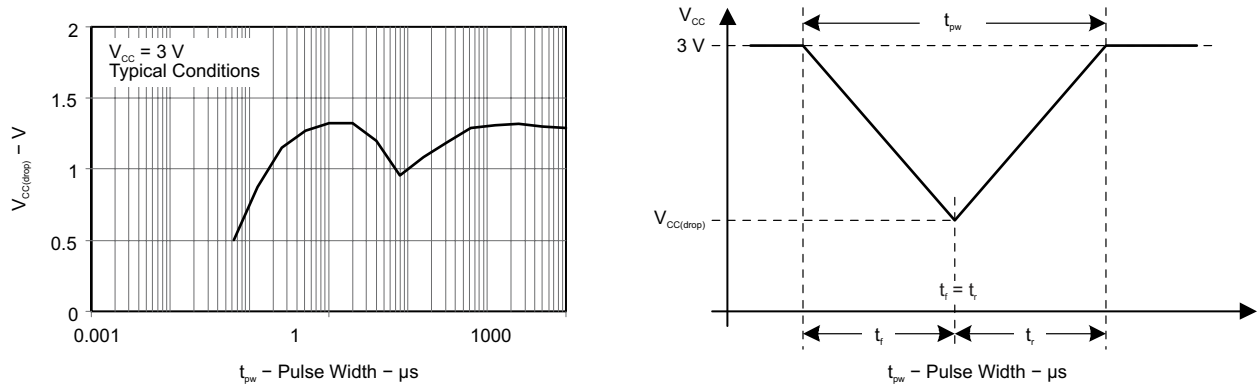

Figure 5-8. $V_{CC(drop)}$ Level With a Triangular Voltage Drop to Generate a POR or BOR Signal

5.17 SVS (Supply Voltage Supervisor and Monitor)⁽¹⁾

over recommended operating free-air temperature range (unless otherwise noted) (also see Figure 5-10)

PARAMETER	TEST CONDITIONS	MIN	TYP	MAX	UNIT	
$t_{(SVSR)}$	$dV_{CC}/dt > 30 \text{ V/ms}$ (see Figure 5-9)	5		150	μs	
	$dV_{CC}/dt \leq 30 \text{ V/ms}$			2000		
$t_{d(SVson)}$	SVS on, switch from VLD = 0 to VLD \neq 0, $V_{CC} = 3 \text{ V}$	20		150	μs	
t_{settle}	VLD \neq 0 ⁽²⁾			12	μs	
$V_{(SVSstart)}$	VLD \neq 0, $V_{CC}/dt \leq 3 \text{ V/s}$ (see Figure 5-9)		1.55	1.7	V	
$V_{hys(SVS_IT-)}$	$V_{CC}/dt \leq 3 \text{ V/s}$ (see Figure 5-9)	VLD = 1	70	120	155	mV
		VLD = 2 to 14	$V_{(SVS_IT-)} \times 0.004$		$V_{(SVS_IT-)} \times 0.008$	
	$V_{CC}/dt \leq 3 \text{ V/s}$ (see Figure 5-9), external voltage applied on P2.3	VLD = 15	4.4		10.4	mV
$V_{(SVS_IT-)}$	$V_{CC}/dt \leq 3 \text{ V/s}$ (see Figure 5-9)	VLD = 1	1.8	1.9	2.05	V
		VLD = 2	1.94	2.1	2.25	
		VLD = 3	2.05	2.2	2.37	
		VLD = 4	2.14	2.3	2.48	
		VLD = 5	2.24	2.4	2.6	
		VLD = 6	2.33	2.5	2.71	
		VLD = 7	2.46	2.65	2.86	
		VLD = 8	2.58	2.8	3	
		VLD = 9	2.69	2.9	3.13	
		VLD = 10	2.83	3.05	3.29	
		VLD = 11	2.94	3.2	3.42	
		VLD = 12	3.11	3.35	3.61 ⁽³⁾	
		VLD = 13	3.24	3.5	3.76 ⁽³⁾	
		VLD = 14	3.43	3.7 ⁽³⁾	3.99 ⁽³⁾	
	$V_{CC}/dt \leq 3 \text{ V/s}$ (see Figure 5-9), external voltage applied on P2.3	VLD = 15	1.1	1.2	1.3	
$I_{CC(SVS)}$ ⁽¹⁾	VLD \neq 0, $V_{CC} = 2.2 \text{ V}$ or 3 V		10	15	μA	

(1) The current consumption of the SVS module is not included in the I_{CC} current consumption data.

(2) t_{settle} is the settling time that the comparator o/p must have a stable level after VLD is switched from VLD \neq 0 to a different VLD value between 2 and 15. The overdrive is assumed to be $> 50 \text{ mV}$.

(3) The recommended operating voltage range is limited to 3.6 V.

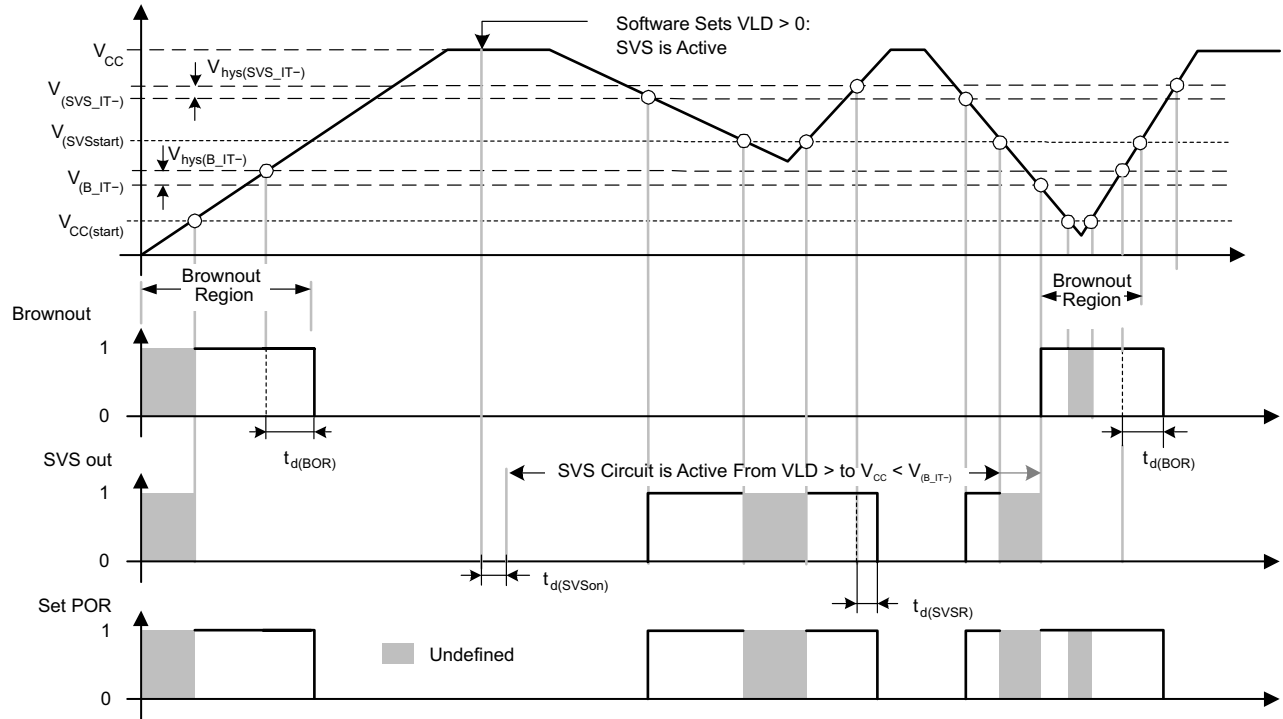

Figure 5-9. SVS Reset (SVSR) vs Supply Voltage

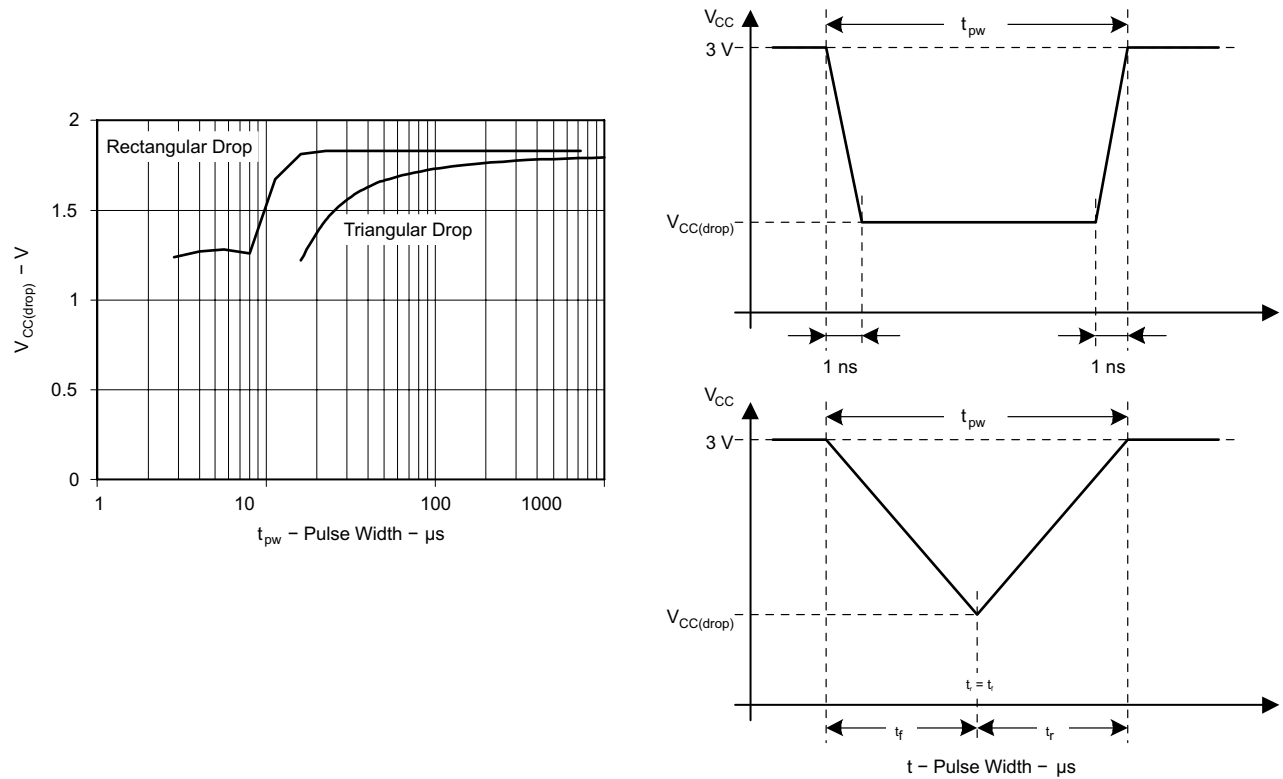

Figure 5-10. $V_{CC(drop)}$ With a Rectangular Voltage Drop and a Triangular Voltage Drop to Generate an SVS Signal

5.18 DCO

over recommended operating free-air temperature range (unless otherwise noted) (also see [Figure 5-11](#) through [Figure 5-13](#))

PARAMETER	TEST CONDITIONS	V _{CC}	MIN	TYP	MAX	UNIT
f _(DCOCLK)	N _(DCO) = 01Eh, FN ₈ = FN ₄ = FN ₃ = FN ₂ = 0, D = 2, DCOPLUS = 0, f _{Crystal} = 32.768 kHz	3 V		1		MHz
f _(DCO = 2)	FN ₈ = FN ₄ = FN ₃ = FN ₂ = 0, DCOPLUS = 1	3 V	0.3	0.7	1.3	MHz
f _(DCO = 27)	FN ₈ = FN ₄ = FN ₃ = FN ₂ = 0, DCOPLUS = 1	3 V	2.7	6.1	11.3	MHz
f _(DCO = 2)	FN ₈ = FN ₄ = FN ₃ = FN ₂ = 1, DCOPLUS = 1	3 V	0.8	1.5	2.5	MHz
f _(DCO = 27)	FN ₈ = FN ₄ = FN ₃ = FN ₂ = 1, DCOPLUS = 1	3 V	6.5	12.1	20	MHz
f _(DCO = 2)	FN ₈ = FN ₄ = 0, FN ₃ = 1, FN ₂ = x, DCOPLUS = 1	3 V	1.3	2.2	3.5	MHz
f _(DCO = 27)	FN ₈ = FN ₄ = 0, FN ₃ = 1, FN ₂ = x, DCOPLUS = 1	3 V	10.3	17.9	28.5	MHz
f _(DCO = 2)	FN ₈ = 0, FN ₄ = 1, FN ₃ = FN ₂ = x, DCOPLUS = 1	3 V	2.1	3.4	5.2	MHz
f _(DCO = 27)	FN ₈ = 0, FN ₄ = 1, FN ₃ = FN ₂ = x, DCOPLUS = 1	3 V	16	26.6	41	MHz
f _(DCO = 2)	FN ₈ = 1, FN ₄ = 1 = FN ₃ = FN ₂ = x, DCOPLUS = 1	3 V	4.2	6.3	9.2	MHz
f _(DCO = 27)	FN ₈ = 1, FN ₄ = 1 = FN ₃ = FN ₂ = x, DCOPLUS = 1	3 V	30	46	70	MHz
S _n	Step size (ratio) between adjacent DCO taps: S _n = f _{DCO(Tap n+1)} /f _{DCO(Tap n)} (see Figure 5-12 for taps 21 to 27)	1 < TAP ≤ 20	1.06		1.11	
		TAP = 27	1.07		1.17	
D _t	Temperature drift, N _(DCO) = 01Eh, FN ₈ = FN ₄ = FN ₃ = FN ₂ = 0, D = 2, DCOPLUS = 0	3 V	-0.2	-0.3	-0.4	%/°C
D _V	Drift with V _{CC} variation, N _(DCO) = 01Eh, FN ₈ = FN ₄ = FN ₃ = FN ₂ = 0, D = 2, DCOPLUS = 0		0	5	15	%/V

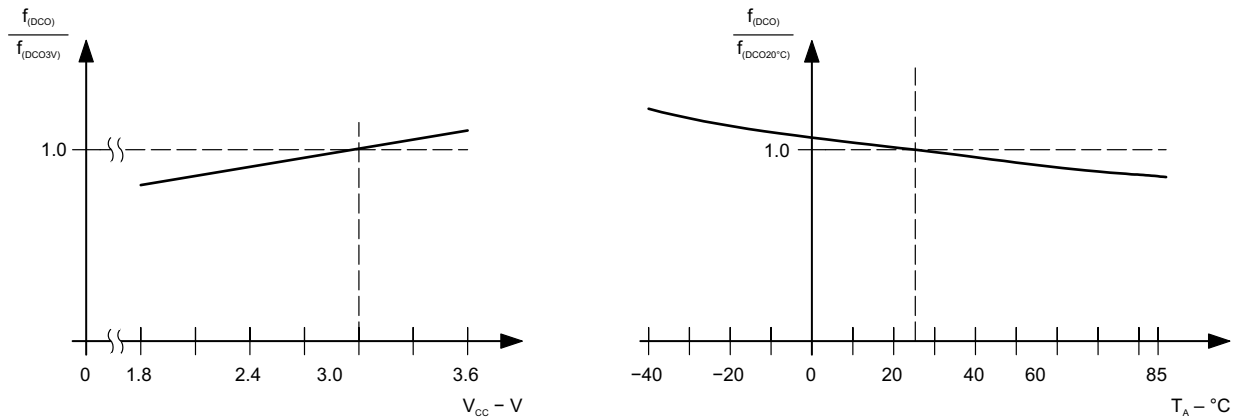

Figure 5-11. DCO Frequency vs Supply Voltage V_{CC} and vs Ambient Temperature

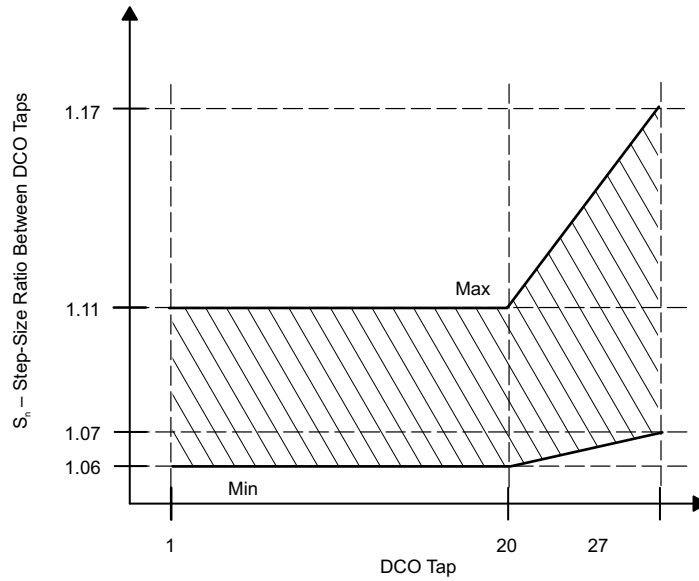

Figure 5-12. DCO Tap Step Size

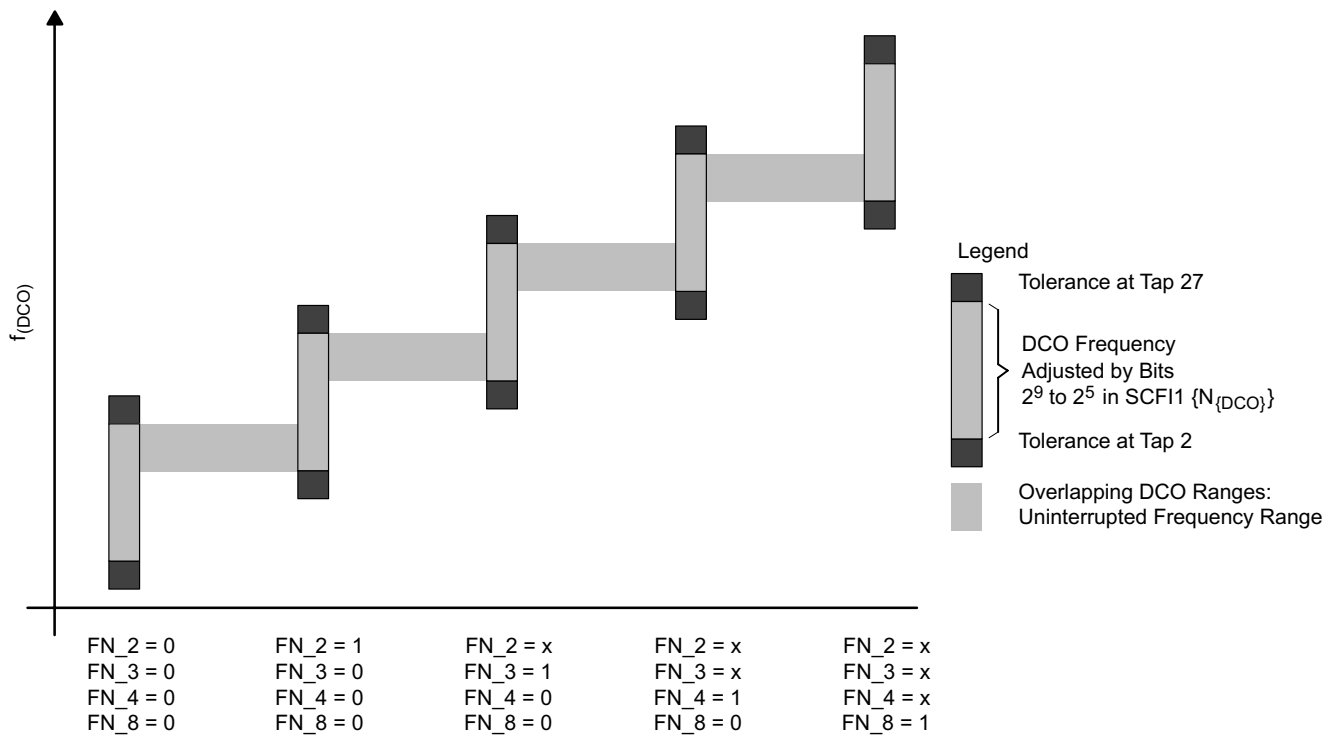

Figure 5-13. Five Overlapping DCO Ranges Controlled by FN_x Bits

5.19 Crystal Oscillator, LFXT1 Oscillator^{(1) (2)}

over recommended operating free-air temperature range (unless otherwise noted)

PARAMETER		TEST CONDITIONS	V _{CC}	MIN	TYP	MAX	UNIT
C _{XIN}	Integrated input capacitance ⁽³⁾	OSCCAPx = 0h	3 V		0		pF
		OSCCAPx = 1h			10		
		OSCCAPx = 2h			14		
		OSCCAPx = 3h			18		
C _{XOUT}	Integrated output capacitance ⁽³⁾	OSCCAPx = 0h	3 V		0		pF
		OSCCAPx = 1h			10		
		OSCCAPx = 2h			14		
		OSCCAPx = 3h			18		
V _{IL}	Input levels at XIN ⁽⁴⁾		2.2 V, 3 V	V _{SS}		0.2 × V _{CC}	V
V _{IH}				0.8 × V _{CC}		V _{CC}	

- (1) The parasitic capacitance from the package and board may be estimated to be 2 pF. The effective load capacitor for the crystal is $(C_{XIN} \times C_{XOUT}) / (C_{XIN} + C_{XOUT})$. This is independent of XTS_FLL.
- (2) To improve EMI on the low-power LFXT1 oscillator, particularly in the LF mode (32 kHz), the following guidelines should be observed.
 - Keep the trace between the device and the crystal as short as possible.
 - Design a good ground plane around the oscillator pins.
 - Prevent crosstalk from other clock or data lines into oscillator pins XIN and XOUT.
 - Avoid running PCB traces underneath or adjacent to the XIN and XOUT pins.
 - Use assembly materials and processes that avoid any parasitic load on the oscillator XIN and XOUT pins.
 - If conformal coating is used, ensure that it does not induce capacitive or resistive leakage between the oscillator pins.
 - Do not route the XOUT line to the JTAG header to support the serial programming adapter as shown in other documentation. This signal is no longer required for the serial programming adapter.
- (3) TI recommends external capacitance for precision real-time clock applications; OSCCAPx = 0h.
- (4) Applies only when using an external logic-level clock source. XTS_FLL must be set. Not applicable when using a crystal or resonator.

5.20 ESP430CE1, SD16 and ESP430 Power Supply and Operating Conditions

over recommended operating free-air temperature range (unless otherwise noted)

PARAMETER		TEST CONDITIONS		V _{CC}	MIN	TYP	MAX	UNIT
AV _{CC}	Analog supply voltage	AV _{CC} = DV _{CC} , AV _{SS} = DV _{SS} = 0 V			2.7		3.6	V
I _{ESP430CE1}	Total digital and analog supply current when ESP430 and SD16 active (I _{AVCC} + I _{DVCC})	SD16LP = 0, f _{MCLK} = 4 MHz, f _{SD16} = f _{MCLK} / 4, SD16REFON = 1, SD16VMIDON = 0	GAIN(V): 1, GAIN(I1): 1, I2: off	3 V		2.0	2.6	mA
			GAIN(V): 1, GAIN(I1): 32, I2: off			2.4	3.3	
			GAIN(V): 1, GAIN(I1): 1, GAIN(I2): 1			2.7	3.6	
			GAIN(V): 1, GAIN(I1): 32, GAIN(I2): 32			3.4	4.9	
		SD16LP = 1, f _{MCLK} = 2 MHz, f _{SD16} = f _{MCLK} / 4, SD16REFON = 1, SD16VMIDON = 0	GAIN(V): 1, GAIN(I1): 1, I2: off			1.5	2.1	
			GAIN(V): 1, GAIN(I1): 32, I2: off			1.6	2.1	
			GAIN(V): 1, GAIN(I1): 1, GAIN(I2): 1			2.1	2.8	
			GAIN(V): 1, GAIN(I1): 32, GAIN(I2): 32			2.2	3.0	
I _{SD16}	Analog supply current: 1 active SD16 channel including internal reference (ESP430 disabled)	SD16LP = 0, f _{SD16} = 1 MHz, SD16OSR = 256	GAIN: 1, 2	3 V		650	950	μA
			GAIN: 4, 8, 16			730	1100	
			GAIN: 32			1050	1550	
		SD16LP = 1, f _{SD16} = 0.5 MHz, SD16OSR = 256	GAIN: 1			620	930	
			GAIN: 32			700	1060	
f _{MAINS}	Mains frequency range				33		80	Hz
f _{SD16}	Analog front-end input clock frequency	SD16LP = 0 (low-power mode disabled)				1		MHz
		SD16LP = 1 (low-power mode enabled)				0.5		

5.21 ESP430CE1, SD16 Input Range⁽¹⁾

over operating free-air temperature range (unless otherwise noted)

PARAMETER		TEST CONDITIONS		V _{CC}	MIN	TYP	MAX	UNIT
V _{ID}	Differential input voltage range for specified performance ⁽²⁾	SD16GAIN _x = 1, SD16REFON = 1				±500		mV
		SD16GAIN _x = 2, SD16REFON = 1				±250		
		SD16GAIN _x = 4, SD16REFON = 1				±125		
		SD16GAIN _x = 8, SD16REFON = 1				±62		
		SD16GAIN _x = 16, SD16REFON = 1				±31		
		SD16GAIN _x = 32, SD16REFON = 1				±15		
Z _I	Input impedance (one input pin to AV _{SS})	f _{SD16} = 1 MHz, SD16GAIN _x = 1		3 V		200		kΩ
		f _{SD16} = 1 MHz, SD16GAIN _x = 32				75		
Z _{ID}	Differential input impedance (IN+ to IN-)	f _{SD16} = 1 MHz, SD16GAIN _x = 1		3 V	300	400		kΩ
		f _{SD16} = 1 MHz, SD16GAIN _x = 32			100	150		
V _I	Absolute input voltage range				AV _{SS} - 1		AV _{CC}	V
V _{IC}	Common-mode input voltage range				AV _{SS} - 1		AV _{CC}	V

(1) All parameters pertain to each SD16 channel.

(2) The analog input range depends on the reference voltage applied to V_{REF}. If V_{REF} is sourced externally, the full-scale range is defined by V_{FSR+} = +(V_{REF} / 2) / GAIN and V_{FSR-} = -(V_{REF} / 2) / GAIN. The analog input range should not exceed 80% of V_{FSR+} or V_{FSR-}.

5.22 ESP430CE1, SD16 Performance

 $f_{SD16} = 1 \text{ MHz}$, $SD16OSRx = 256$, $SD16REFON = 1$, over operating free-air temperature range (unless otherwise noted)

PARAMETER	TEST CONDITIONS	V _{CC}	MIN	TYP	MAX	UNIT	
SINAD Signal-to-noise + distortion ratio	SD16GAINx = 1, signal amplitude = 500 mV	3 V	f _{IN} = 50 Hz or 100 Hz	83.5	85	dB	
	SD16GAINx = 2, signal amplitude = 250 mV			81.5	84		
	SD16GAINx = 4, signal amplitude = 125 mV			76	79.5		
	SD16GAINx = 8, signal amplitude = 62 mV			73	76.5		
	SD16GAINx = 16, signal amplitude = 31 mV			69	73		
	SD16GAINx = 32, signal amplitude = 15 mV			62	69		
G Nominal gain	SD16GAINx = 1	3 V	0.97	1.00	1.02		
	SD16GAINx = 2		1.90	1.96	2.02		
	SD16GAINx = 4		3.76	3.86	3.96		
	SD16GAINx = 8		7.36	7.62	7.84		
	SD16GAINx = 16		14.56	15.04	15.52		
	SD16GAINx = 32		27.20	28.35	29.76		
E _{OS} Offset error	SD16GAINx = 1	3 V				±0.2	%FSR
	SD16GAINx = 32					±1.5	
dE _{OS} /dT Offset error temperature coefficient	SD16GAINx = 1	3 V				±4	ppm FSR/°C
	SD16GAINx = 32					±20	
CMRR Common-mode rejection ratio	SD16GAINx = 1, Common-mode input signal: V _{ID} = 500 mV, f _{IN} = 50 Hz or 100 Hz	3 V				>90	dB
	SD16GAINx = 32, Common-mode input signal: V _{ID} = 16 mV, f _{IN} = 50 Hz or 100 Hz					>75	
AC PSRR AC power-supply rejection ratio	SD16GAINx = 1, V _{CC} = 3 V ±100 mV, f _{VCC} = 50 Hz	3 V				>80	dB
XT Crosstalk		3 V				<-100	dB

5.23 ESP430CE1, SD16 Temperature Sensor⁽¹⁾

over operating free-air temperature range (unless otherwise noted)

PARAMETER	TEST CONDITIONS	V _{CC}	MIN	TYP	MAX	UNIT
TC _{Sensor} Sensor temperature coefficient			1.18	1.32	1.46	mV/K
V _{Offset,sensor} Sensor offset voltage			-100		100	mV
V _{Sensor} Sensor output voltage ⁽²⁾	Temperature sensor voltage at T _A = 85°C	3 V	435	475	515	mV
	Temperature sensor voltage at T _A = 25°C		355	395	435	
	Temperature sensor voltage at T _A = 0°C		320	360	400	

(1) The following formula can be used to calculate the temperature sensor output voltage:

$$V_{\text{Sensor,typ}} = TC_{\text{Sensor}} (273 + T [^{\circ}\text{C}]) + V_{\text{Offset,sensor}} [\text{mV}]$$

 (2) Results based on characterization or production test, no TC_{Sensor} or V_{Offset,sensor}.

5.24 ESP430CE1, SD16 Built-in Voltage Reference

over operating free-air temperature range (unless otherwise noted)

PARAMETER		TEST CONDITIONS	V _{CC}	MIN	TYP	MAX	UNIT
V _{REF}	Internal reference voltage	SD16REFON = 1, SD16VMIDON = 0	3 V	1.14	1.20	1.26	V
I _{REF}	Reference supply current	SD16REFON = 1, SD16VMIDON = 0	3 V		175	260	μA
TC	Temperature coefficient	SD16REFON = 1, SD16VMIDON = 0 ⁽¹⁾	3 V		20	50	ppm/K
C _{REF}	V _{REF} load capacitance	SD16REFON = 1 SD16VMIDON = 0 ⁽²⁾			100		nF
I _{LOAD}	V _{REF(I)} maximum load current	SD16REFON = 0, SD16VMIDON = 0	3 V			±200	nA
t _{ON}	Turnon time	SD16REFON = 0 → 1, SD16VMIDON = 0, C _{REF} = 100 nF	3 V		5		ms
DC PSR	DC power supply rejection, ΔV _{REF} /ΔV _{CC}	SD16REFON = 1, SD16VMIDON = 0, V _{CC} = 2.5 V to 3.6 V			200		μV/V

(1) Calculated using the box method: (MAX(−40°C to 85°C) – MIN(−40°C to 85°C)) / MIN(−40°C to 85°C) / (85°C – (−40°C)).

(2) There is no capacitance required on V_{REF}. However, TI recommends a capacitance of at least 100 nF to reduce any reference voltage noise.

5.25 ESP430CE1, SD16 Reference Output Buffer

over operating free-air temperature range (unless otherwise noted)

PARAMETER		TEST CONDITIONS	V _{CC}	MIN	TYP	MAX	UNIT
V _{REF,BUF}	Reference buffer output voltage	SD16REFON = 1, SD16VMIDON = 1	3 V		1.2		V
I _{REF,BUF}	Reference supply and reference output buffer quiescent current	SD16REFON = 1, SD16VMIDON = 1	3 V		385	600	A
C _{REF(O)}	Required load capacitance on V _{REF}	SD16REFON = 1, SD16VMIDON = 1		470			nF
I _{LOAD,Max}	Maximum load current on V _{REF}	SD16REFON = 1, SD16VMIDON = 1	3 V			±1	mA
	Maximum voltage variation versus load current	I _{LOAD} = 0 to 1 mA	3 V	−15		+15	mV
t _{ON}	Turnon time	SD16REFON = 0 → 1, SD16VMIDON = 0, C _{REF} = 100 nF	3 V		100		μs

5.26 ESP430CE1, SD16 External Reference Input

over operating free-air temperature range (unless otherwise noted)

PARAMETER		TEST CONDITIONS	V _{CC}	MIN	TYP	MAX	UNIT
V _{REF(I)}	Input voltage	SD16REFON = 0	3 V	1.0	1.25	1.5	V
I _{REF(I)}	Input current	SD16REFON = 0	3 V			50	nA

5.27 ESP430CE1, Active Energy Measurement Test Conditions and Accuracy⁽¹⁾

$T_A = 25^\circ\text{C}$, input conditions (unless otherwise noted): $I_B = 6\text{ A}$, $I_{MAX} = n \times I_B = 60\text{ A}$, $n = 10$, $V_N = 230\text{ V}$, $f_{MAINS} = 50\text{ Hz}$

PARAMETER	TEST CONDITIONS	V_{CC}	TYP	UNIT
Maximum error ⁽²⁾⁽³⁾	$I = 0.05 \times I_B$, $V = V_N$, PF = 1.0	3 V	$\pm 0.17\%$	
	$I = 0.1 \times I_B$ to I_{MAX} , $V = V_N$, PF = 1.0		$\pm 0.18\%$	
	$I = 0.1 \times I_B$, $V = V_N$, PF = 0.5 lagging		$\pm 0.19\%$	
	$I = 0.2 \times I_B$ to I_{MAX} , $V = V_N$, PF = 0.5 lagging		$\pm 0.27\%$	
	$I = 0.1 \times I_B$, $V = V_N$, PF = 0.8 leading		$\pm 0.15\%$	
	$I = 0.2 \times I_B$ to I_{MAX} , $V = V_N$, PF = 0.8 leading		$\pm 0.24\%$	
	$I = 0.2 \times I_B$ to I_{MAX} , $V = V_N$, PF = 0.25 lagging		$\pm 0.38\%$	

(1)

- $f_{ACLK} = 32768\text{ Hz}$ (watch crystal)
- $f_{MCLK} = 4.194\text{ MHz}$ (FLL+)
- $f_{SD16} = f_{MCLK} / 4 = 1.049\text{ MHz}$
- Single-point calibration at $I = 10\text{ A}$ and PF = 0.5 lagging
- Measurements according to IEC1036

(2) Measurements performed using complete hardware solution. Error shown contain temperature dependencies of all components including the MSP430FE42x, crystal, and discrete components.

- (3) I1 SD16GAIN x = 1 or 4: CT part number = T60404-E4624-X101 (Vacuumschmelze)
 I1 SD16GAINx = 8: shunt part number = A-H2-R005-F1-K2-0.1 (Isabellenhütte Heusler GmbH KG)
 I1 SD16GAINx = 32: shunt part number = BVO-M-R0002-5.0 (Isabellenhütte Heusler GmbH KG)

5.28 ESP430CE1, Active Energy Measurement Test Conditions and Accuracy⁽¹⁾

$T_A = 25^\circ\text{C}$, input conditions (unless otherwise noted): $I_B = 10\text{ A}$, $I_{MAX} = n \times I_B = 60\text{ A}$, $n = 6$, $V_N = 230\text{ V}$, $f_{MAINS} = 50\text{ Hz}$

PARAMETER	TEST CONDITIONS	V_{CC}	TYP	UNIT
Maximum error ⁽²⁾⁽³⁾	$I = 0.05 \times I_B$, $V = V_N$, PF = 1.0	3 V	$\pm 0.11\%$	
	$I = 0.1 \times I_B$ to I_{MAX} , $V = V_N$, PF = 1.0		$\pm 0.18\%$	
	$I = 0.1 \times I_B$, $V = V_N$, PF = 0.5 lagging		$\pm 0.45\%$	
	$I = 0.2 \times I_B$ to I_{MAX} , $V = V_N$, PF = 0.5 lagging		$\pm 0.33\%$	
	$I = 0.1 \times I_B$, $V = V_N$, PF = 0.8 leading		$\pm 0.10\%$	
	$I = 0.2 \times I_B$ to I_{MAX} , $V = V_N$, PF = 0.8 leading		$\pm 0.18\%$	
	$I = 0.2 \times I_B$ to I_{MAX} , $V = V_N$, PF = 0.25 lagging		$\pm 0.51\%$	

(1)

- $f_{ACLK} = 32768\text{ Hz}$ (watch crystal)
- $f_{MCLK} = 4.194\text{ MHz}$ (FLL+)
- $f_{SD16} = f_{MCLK} / 4 = 1.049\text{ MHz}$
- Single-point calibration at $I = 10\text{ A}$ and PF = 0.5 lagging
- Measurements according to IEC1036

(2) Measurements performed using complete hardware solution. Error shown contain temperature dependencies of all components including the MSP430FE42x, crystal, and discrete components.

- (3) I1 SD16GAIN x = 1 or 4: CT part number = T60404-E4624-X101 (Vacuumschmelze)
 I1 SD16GAINx = 8: shunt part number = A-H2-R005-F1-K2-0.1 (Isabellenhütte Heusler GmbH KG)
 I1 SD16GAINx = 32: shunt part number = BVO-M-R0002-5.0 (Isabellenhütte Heusler GmbH KG)

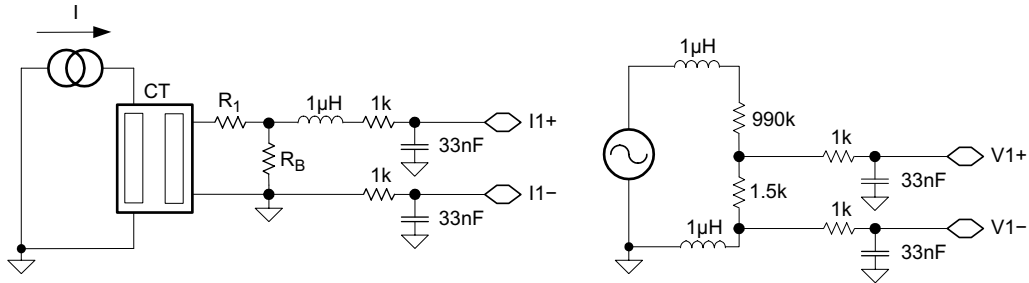

Figure 5-14. Energy Measurement Test Circuitry (SD16GAINx = 1 or 4)

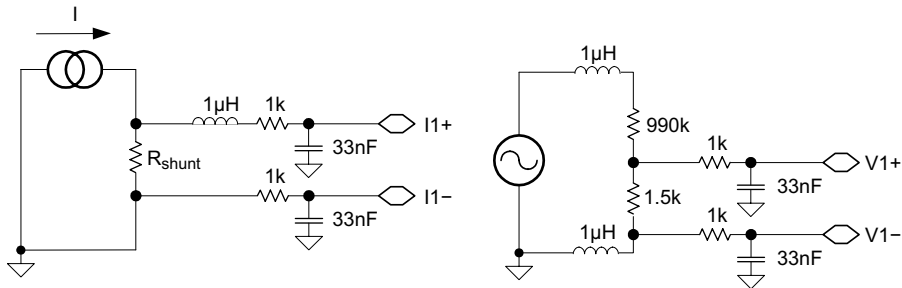
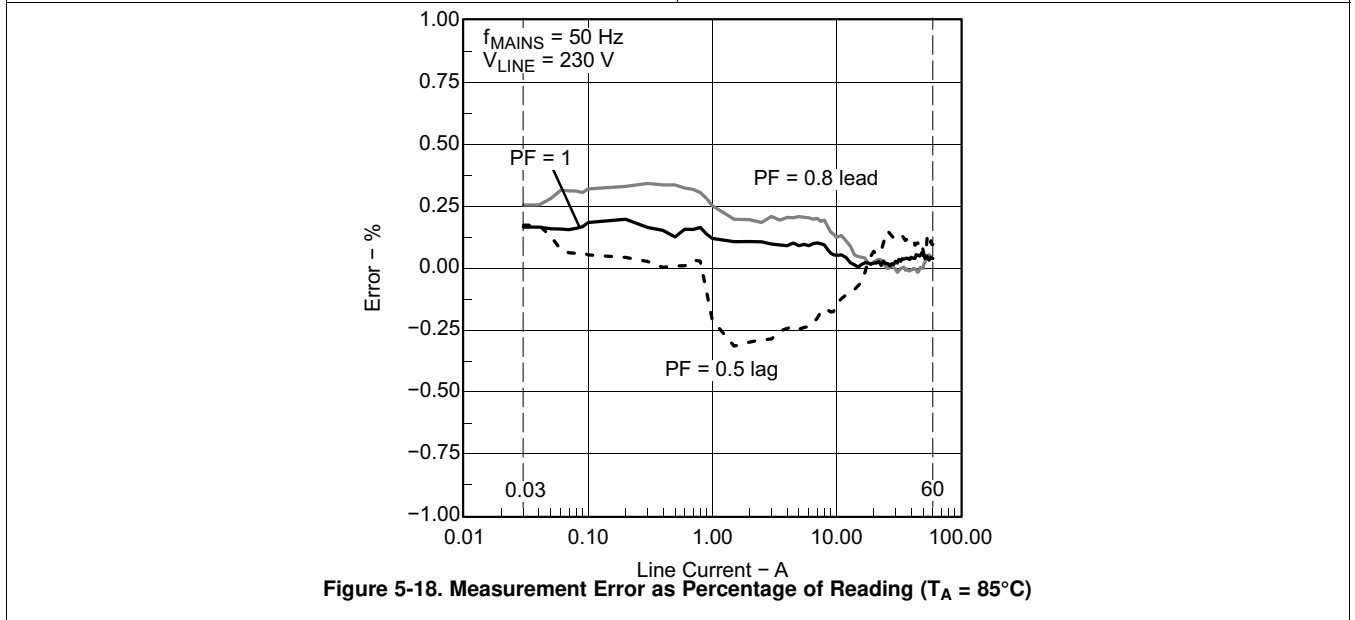
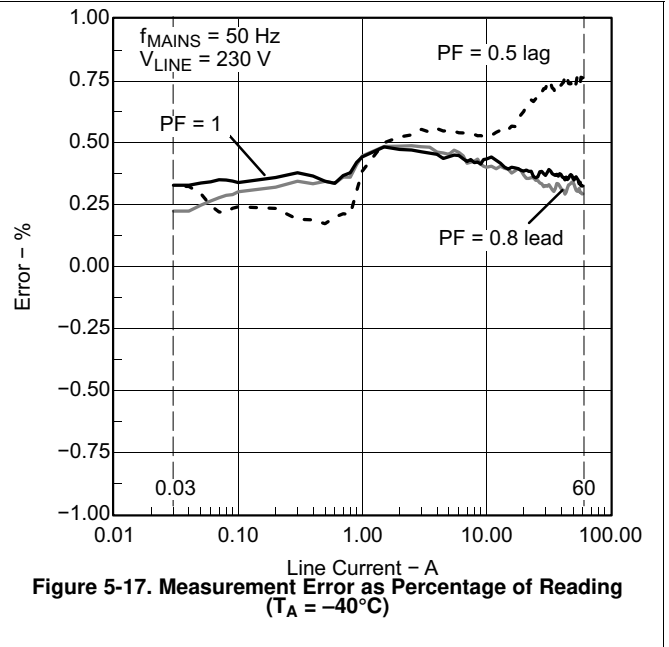
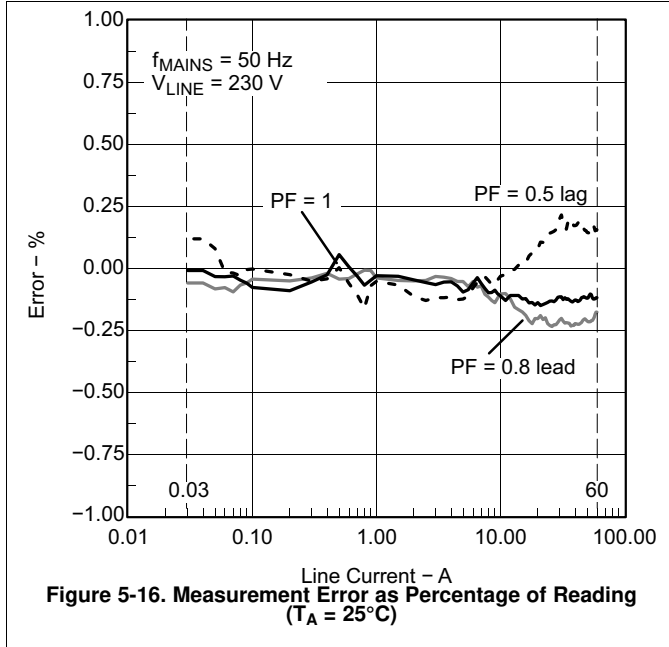

Figure 5-15. Energy Measurement Test Circuitry (SD16GAINx = 8 or 32)

5.29 ESP430CE1 Typical Characteristics (I1 SD16GAINx = 1)

Results corrected for typical phase error of CT used (−40°C to 25°C: −0.7°; 25°C to 85°C: +0.5°). See Figure 5-14 for test circuitry: CT part number = T60404-E4624-X101 (Vacuumschmelze), $R_1 = 0 \Omega$, $R_B = 12.4 \Omega$



5.30 ESP430CE1 Typical Characteristics (I1 SD16GAINx = 4)

Results corrected for typical phase error of CT used (–40°C to 25°C: –0.7°; 25°C to 85°C: +0.5°). See [Figure 5-14](#) for test circuitry: CT part number = T60404-E4624-X101 (Vacuumschmelze), $R_1 = 9.36 \Omega$, $R_B = 3.16 \Omega$

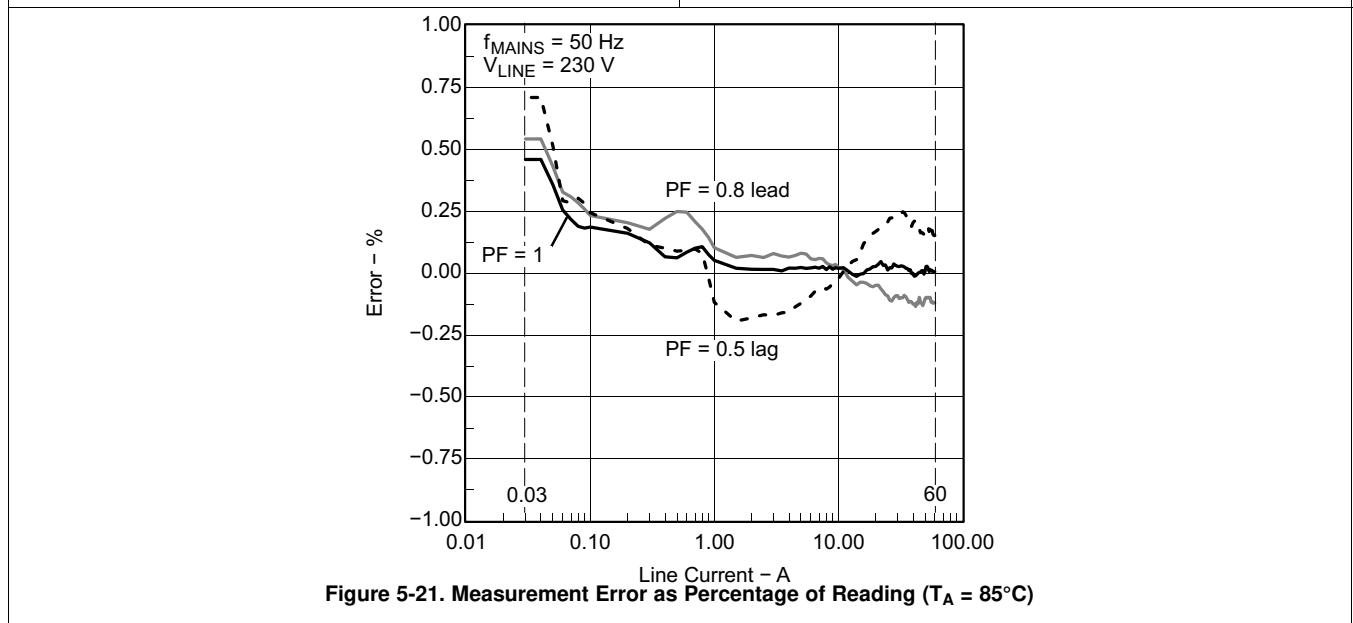
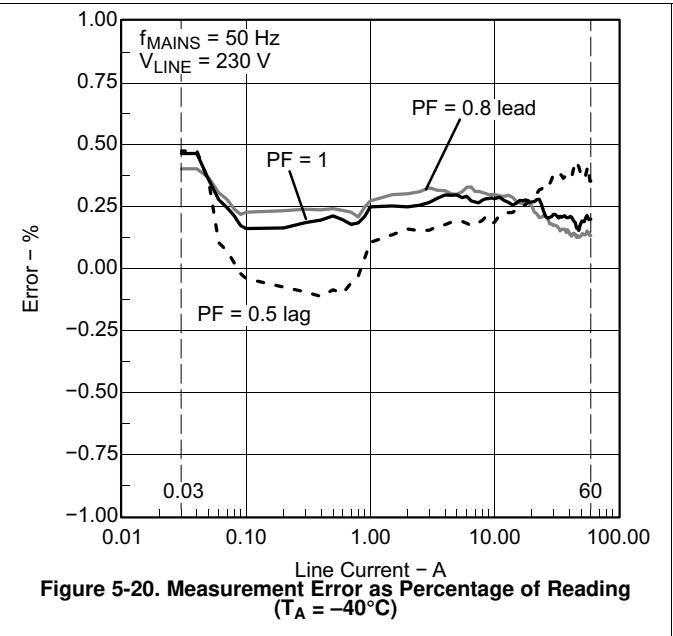
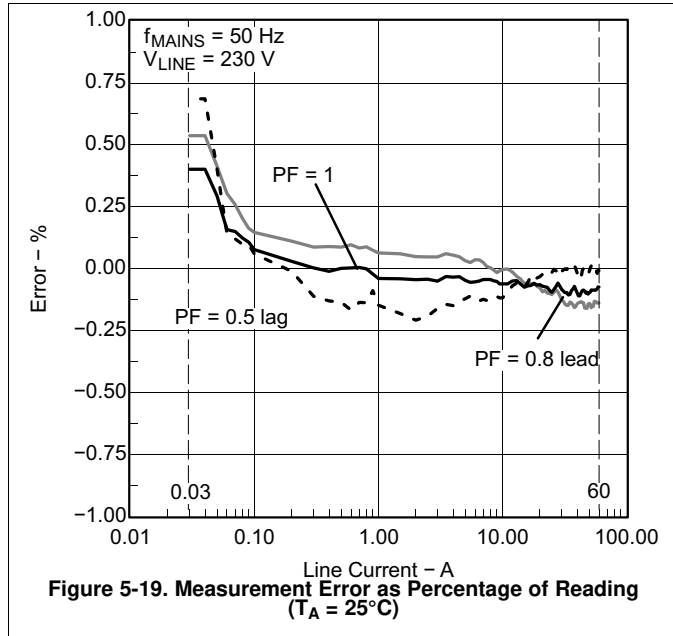

5.31 ESP430CE1 Typical Characteristics (I1 SD16GAINx = 8)

See Figure 5-15 for test circuitry: shunt part number = A-H2-R005-F1-K2-0.1 (Isabellenhütte Heusler GmbH KG)

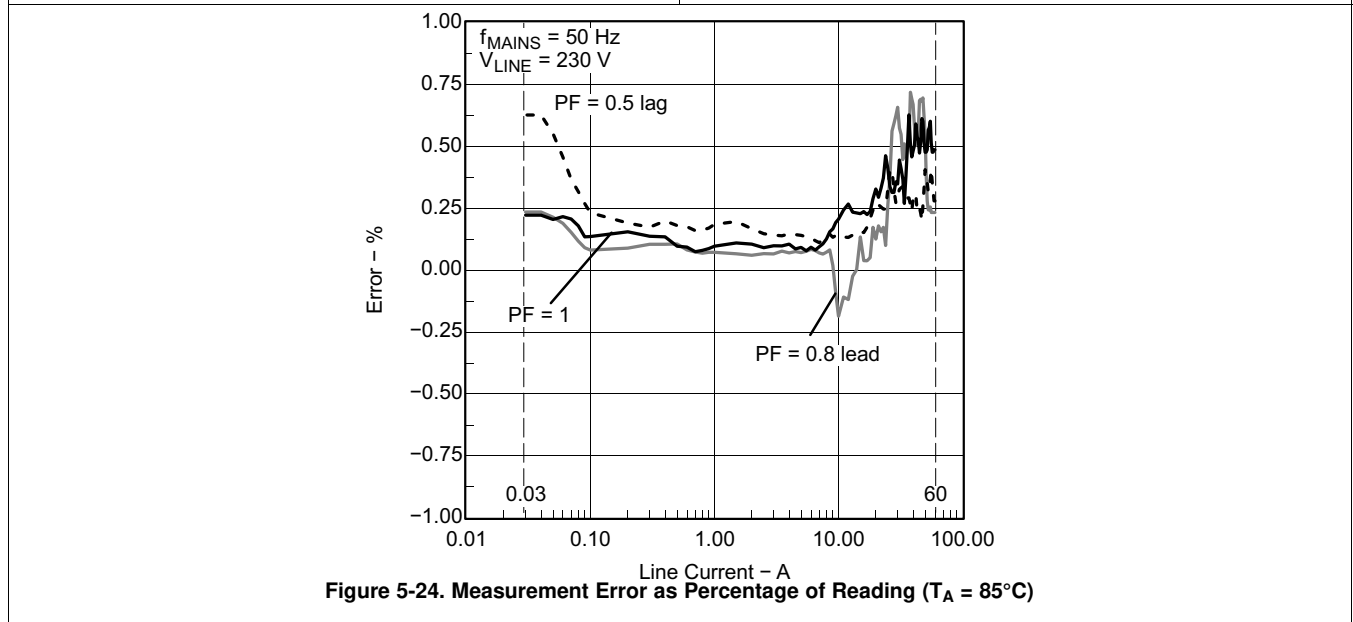
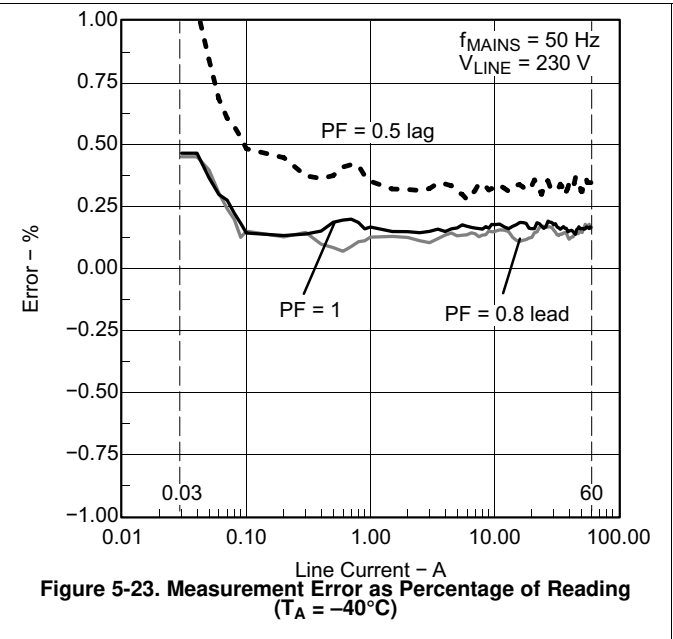
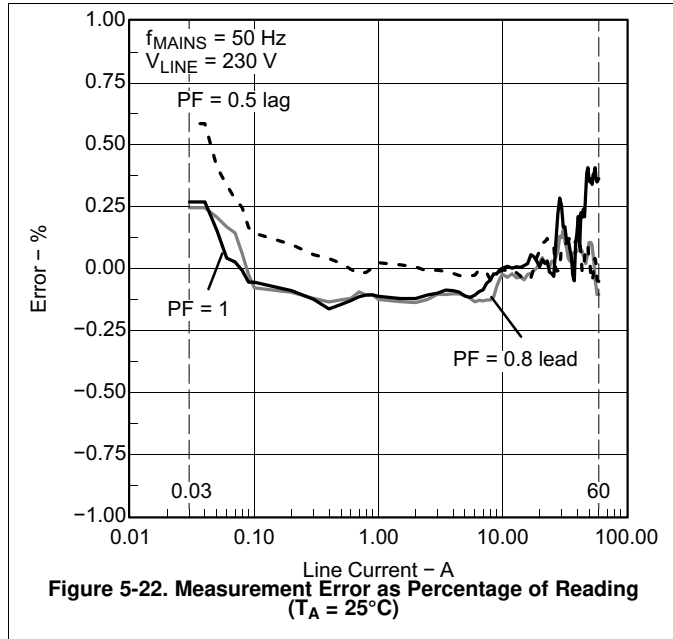

5.32 ESP430CE1 Typical Characteristics (I1 SD16GAINx = 32)

See [Figure 5-15](#) for test circuitry: shunt part number = BVO-M-R0002-5.0 (Isabellenhütte Heusler GmbH KG)

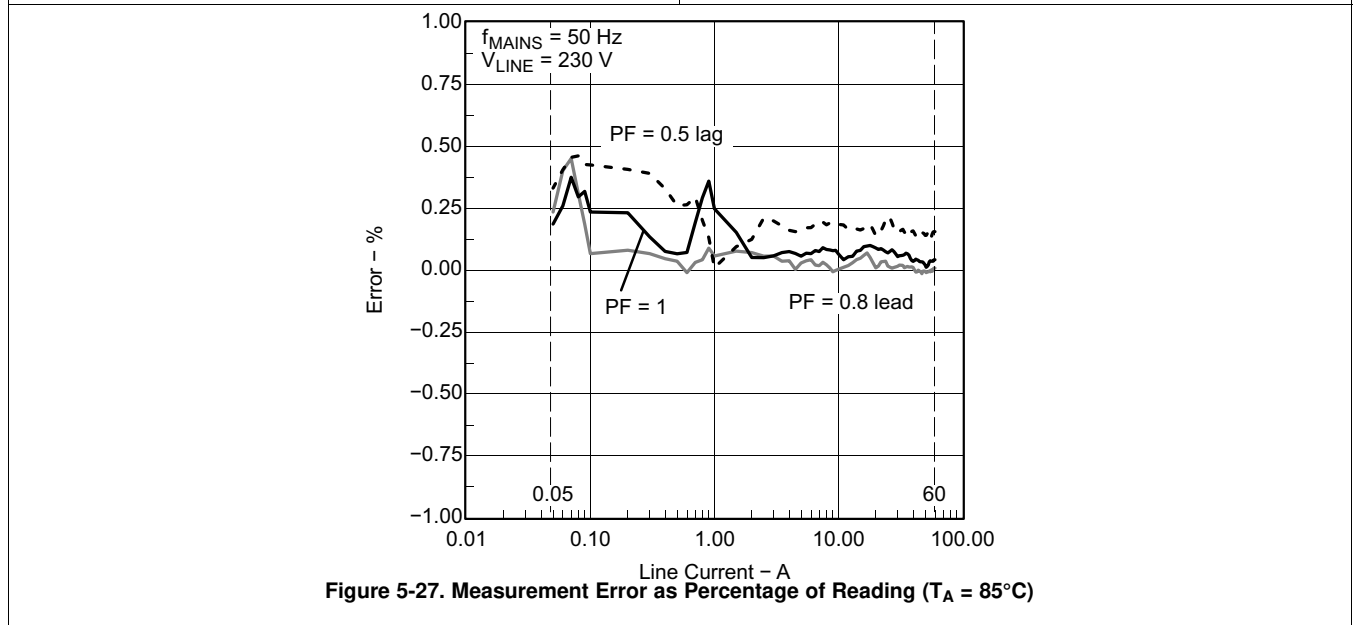
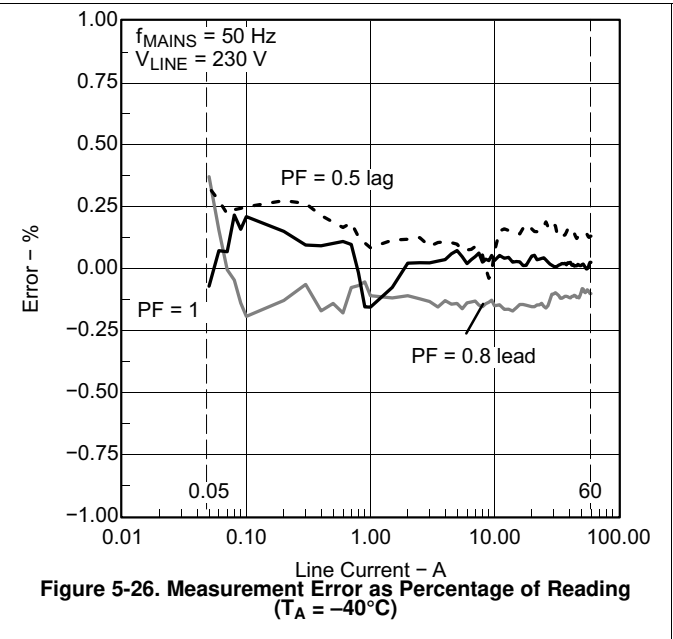
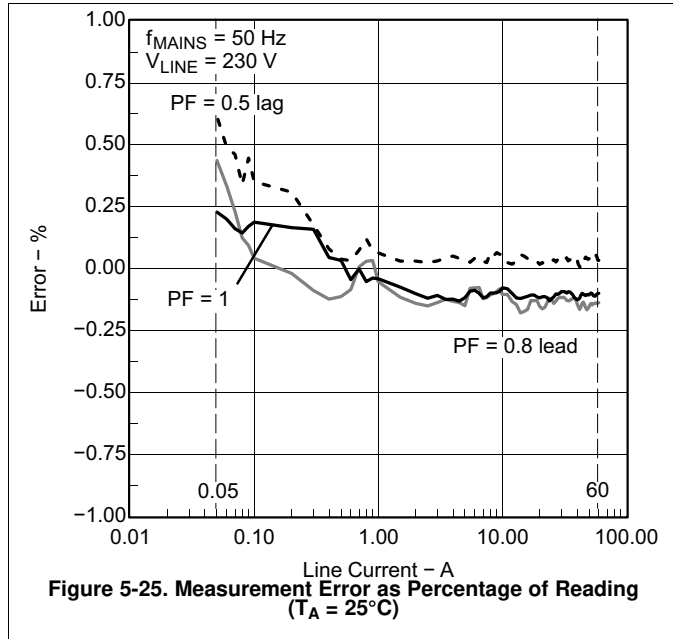

5.33 Flash Memory

over recommended operating free-air temperature range (unless otherwise noted)

PARAMETER		TEST CONDITIONS	V _{CC}	MIN	TYP	MAX	UNIT
V _{CC(PGM/ERASE)}	Program and erase supply voltage			2.7		3.6	V
f _{FTG}	Flash timing generator frequency			257		476	kHz
I _{PGM}	Supply current from DV _{CC} during program		2.7 V, 3.6 V		3	5	mA
I _{ERASE}	Supply current from DV _{CC} during erase		2.7 V, 3.6 V		3	7	mA
t _{CPT}	Cumulative program time	See ⁽¹⁾	2.7 V, 3.6 V			10	ms
t _{CMErase}	Cumulative mass erase time	See ⁽²⁾	2.7 V, 3.6 V	200			ms
	Program and erase endurance			10 ⁴	10 ⁵		cycles
t _{Retention}	Data retention duration	T _J = 25°C		100			years
t _{Word}	Word or byte program time	See ⁽³⁾			35		t _{FTG}
t _{Block, 0}	Block program time for first byte or word				30		
t _{Block, 1–63}	Block program time for each additional byte or word				21		
t _{Block, End}	Block program end-sequence wait time				6		
t _{Mass Erase}	Mass erase time				5297		
t _{Seg Erase}	Segment erase time				4819		

- (1) The cumulative program time must not be exceeded when writing to a 64-byte flash block. This parameter applies to all programming methods: individual word or byte write mode and block write mode.
- (2) The mass erase duration generated by the flash timing generator is at least 11.1 ms (= 5297 × (1 / f_{FTG,max}) = 5297 × (1 / 476 kHz)). To achieve the required cumulative mass erase time, the mass erase operation of the flash controller can be repeated until this time is met (a worst case minimum of 19 cycles is required).
- (3) These values are hardwired into the state machine of the flash controller (t_{FTG} = 1 / f_{FTG}).

5.34 JTAG Interface

over recommended operating free-air temperature range (unless otherwise noted)

PARAMETER		TEST CONDITIONS	V _{CC}	MIN	TYP	MAX	UNIT
f _{TCK}	TCK input frequency	See ⁽¹⁾	2.2 V	0		5	MHz
			3V	0		10	
R _{Internal}	Internal pullup resistance on TMS, TCK, TDI/TCLK	See ⁽²⁾	2.2 V, 3 V	25	60	90	kΩ

- (1) f_{TCK} may be restricted to meet the timing requirements of the module selected.
- (2) TMS, TDI/TCLK, and TCK pullup resistors are implemented in all versions.

5.35 JTAG Fuse⁽¹⁾

over recommended operating free-air temperature range (unless otherwise noted)

PARAMETER		TEST CONDITIONS	MIN	MAX	UNIT
V _{CC(FB)}	Supply voltage during fuse-blow condition	T _A = 25°C	2.5		V
V _{FB}	Voltage level on TDI/TCLK for fuse-blow		6	7	V
I _{FB}	Supply current into TDI/TCLK during fuse blow			100	mA
t _{FB}	Time to blow fuse			1	ms

- (1) After the fuse is blown, no further access to the MSP430 JTAG/Test and emulation features is possible. The JTAG block is switched to bypass mode.

6 Detailed Description

6.1 CPU

The MSP430 CPU has a 16-bit RISC architecture that is highly transparent to the application. All operations, other than program-flow instructions, are performed as register operations in conjunction with seven addressing modes for source operand and four addressing modes for destination operand.

The CPU is integrated with 16 registers that provide reduced instruction execution time. The register-to-register operation execution time is one cycle of the CPU clock.

Four of the registers, R0 to R3, are dedicated as program counter, stack pointer, status register, and constant generator, respectively. The remaining registers are general-purpose registers (see [Figure 6-1](#)).

Peripherals are connected to the CPU using data, address, and control buses. Peripherals can be managed with all instructions.

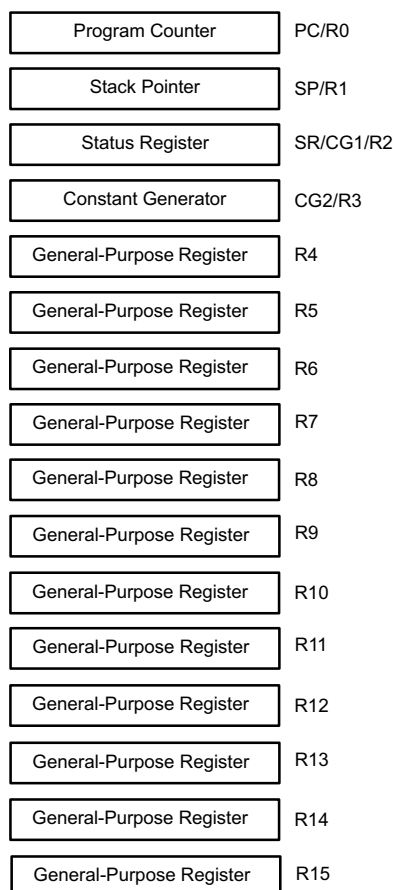

Figure 6-1. CPU Registers

6.2 Instruction Set

The instruction set consists of the original 51 instructions with three formats and seven address modes. Each instruction can operate on word and byte data. [Table 6-1](#) lists examples of the three types of instruction formats; [Table 6-2](#) lists the address modes.

Table 6-1. Instruction Word Formats

INSTRUCTION FORMAT	EXAMPLE	OPERATION
Dual operands, source and destination	ADD R4,R5	$R4 + R5 \rightarrow R5$
Single operand, destination only	CALL R8	$PC \rightarrow (TOS), R8 \rightarrow PC$
Relative jump, unconditional or conditional	JNE	Jump-on-equal bit = 0

Table 6-2. Address Mode Descriptions

ADDRESS MODE	S ⁽¹⁾	D ⁽¹⁾	SYNTAX	EXAMPLE	OPERATION
Register	•	•	MOV Rs, Rd	MOV R10, R11	$R10 \rightarrow R11$
Indexed	•	•	MOV X(Rn), Y(Rm)	MOV 2(R5), 6(R6)	$M(2+R5) \rightarrow M(6+R6)$
Symbolic (PC relative)	•	•	MOV EDE, TONI		$M(EDE) \rightarrow M(TONI)$
Absolute	•	•	MOV & MEM, & TCDAT		$M(MEM) \rightarrow M(TCDAT)$
Indirect	•		MOV @Rn, Y(Rm)	MOV @R10, Tab(R6)	$M(R10) \rightarrow M(Tab+R6)$
Indirect autoincrement	•		MOV @Rn+, Rm	MOV @R10+, R11	$M(R10) \rightarrow R11$ $R10 + 2 \rightarrow R10$
Immediate	•		MOV #X, TONI	MOV #45, TONI	$\#45 \rightarrow M(TONI)$

(1) S = source, D = destination

6.3 Operating Modes

The MSP430FE42x has one active mode and five software-selectable low-power modes of operation. An interrupt event can wake up the device from any of the five low-power modes, service the request, and restore back to the low-power mode on return from the interrupt program.

Software can configure the following operating modes:

- Active mode (AM)
 - All clocks are active.
- Low-power mode 0 (LPM0)
 - CPU is disabled.
 - ACLK and SMCLK remain active, MCLK available to modules.
 - FLL+ loop control remains active.
- Low-power mode 1 (LPM1)
 - CPU is disabled.
 - ACLK and SMCLK remain active, MCLK available to modules.
 - FLL+ loop control is disabled.
- Low-power mode 2 (LPM2)
 - CPU is disabled.
 - MCLK, FLL+ loop control, and DCOCLK are disabled.
 - DC generator of the DCO remains enabled.
 - ACLK remains active.
- Low-power mode 3 (LPM3)
 - CPU is disabled.
 - MCLK, FLL+ loop control, and DCOCLK are disabled.
 - DC generator of the DCO is disabled.
 - ACLK remains active.
- Low-power mode 4 (LPM4)
 - CPU is disabled.
 - ACLK is disabled.
 - MCLK, FLL+ loop control, and DCOCLK are disabled.
 - DC generator of the DCO is disabled.
 - Crystal oscillator is stopped.

6.4 Interrupt Vector Addresses

The interrupt vectors and the power-up starting address are in the address range 0FFFFh to 0FFE0h. The vector contains the 16-bit address of the appropriate interrupt-handler instruction sequence. [Table 6-3](#) lists the interrupt sources, flags, and vectors.

Table 6-3. Interrupt Sources, Flags, and Vectors

INTERRUPT SOURCE	INTERRUPT FLAG	SYSTEM INTERRUPT	WORD ADDRESS	PRIORITY
Power up External reset Watchdog Flash memory PC out of range ⁽¹⁾	WDTIFG KEYV ⁽²⁾	Reset	0FFFEh	15, highest
NMI oscillator fault Flash memory access violation	NMIIFG ⁽²⁾ OFIFG ⁽²⁾ ACCVIFG ⁽²⁾	(Non)maskable ⁽³⁾ (Non)maskable (Non)maskable	0FFFCh	14
ESP430	MBCTL_OUTxIFG, MBCTL_INxIFG ⁽²⁾⁽⁴⁾	Maskable	0FFFAh	13
SD16	SD16CCTLx SD16OVIFG, SD16CCTLx SD16IFG ⁽²⁾⁽⁴⁾	Maskable	0FFF8h	12
			0FFF6h	11
Watchdog timer	WDTIFG	Maskable	0FFF4h	10
USART0 receive	URXIFG0	Maskable	0FFF2h	9
USART0 transmit	UTXIFG0	Maskable	0FFF0h	8
			0FFEEh	7
Timer_A3	TACCR0 CCIFG ⁽⁴⁾	Maskable	0FFECCh	6
Timer_A3	TACCR1 and TACCR2 CCIFGs, and TACTL TAIFG ⁽²⁾⁽⁴⁾	Maskable	0FFEAh	5
I/O port P1 (8 flags)	P1IFG.0 to P1IFG.7 ⁽²⁾⁽⁴⁾	Maskable	0FFE8h	4
			0FFE6h	3
			0FFE4h	2
I/O port P2 (8 flags)	P2IFG.0 to P2IFG.7 ⁽²⁾⁽⁴⁾	Maskable	0FFE2h	1
Basic Timer1	BTIFG	Maskable	0FFE0h	0, lowest

- (1) A reset is generated if the CPU tries to fetch instructions from within the module register memory address range (0h–01FFh) or from within unused address ranges (0600h–0BFFh).
- (2) Multiple source flags
- (3) (Non)maskable: the individual interrupt enable bit can disable an interrupt event, but the general interrupt enable cannot.
- (4) Interrupt flags are in the module.

6.5 Special Function Registers

Most interrupt and module-enable bits are collected in the lowest address space. Special-function register bits not allocated to a functional purpose are not physically present in the device. This arrangement provides simple software access.

Legend

rw	Bit can be read and written.
rw-0, rw-1	Bit can be read and written. It is reset or set by PUC.
rw-(0), rw-(1)	Bit can be read and written. It is reset or set by POR.
	SFR bit is not present in device.

Figure 6-2 shows the Interrupt Enable Register 1, and Table 6-4 describes the bit fields.

Figure 6-2. Interrupt Enable Register 1 (Address = 00h)

7	6	5	4	3	2	1	0
UTXIE0	URXIE0	ACCVIE	NMIIE			OFIE	WDTIE
rw-0	rw-0	rw-0	rw-0			rw-0	rw-0

Table 6-4. Interrupt Enable Register 1 Description

BIT	FIELD	TYPE	RESET	DESCRIPTION
7	UTXIE0	RW	0h	USART0: UART and SPI transmit interrupt enable
6	URXIE0	RW	0h	USART0: UART and SPI receive interrupt enable
5	ACCVIE	RW	0h	Flash access violation interrupt enable
4	NMIIE	RW	0h	(Non)maskable interrupt enable
1	OFIE	RW	0h	Oscillator fault interrupt enable
0	WDTIE	RW	0h	Watchdog timer interrupt enable. Inactive if watchdog mode is selected. Active if watchdog timer is configured in interval timer mode.

Figure 6-3 shows the Interrupt Enable Register 2, and Table 6-5 describes the bit fields.

Figure 6-3. Interrupt Enable Register 2 (Address = 01h)

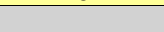
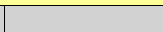



7	6	5	4	3	2	1	0
BTIE							
rw-0							

Table 6-5. Interrupt Enable Register 2 Description

BIT	FIELD	TYPE	RESET	DESCRIPTION
7	BTIE	RW	0h	Basic Timer1 interrupt enable

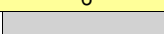
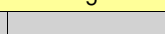
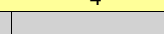
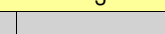
Figure 6-4 shows the Interrupt Flag Register 1, and Table 6-6 describes the bit fields.

Figure 6-4. Interrupt Flag Register 1 (Address = 02h)

7	6	5	4	3	2	1	0
UTXIFG0	URXIFG0		NMIIFG			OFIFG	WDTIFG
rw-1	rw-0		rw-0			rw-1	rw-(0)

Table 6-6. Interrupt Flag Register 1 Description

BIT	FIELD	TYPE	RESET	DESCRIPTION
7	UTXIFG0	RW	1h	USART0: UART and SPI transmit flag
6	URXIFG0	RW	0h	USART0: UART and SPI receive flag
4	NMIIFG	RW	0h	Set by the $\overline{\text{RST}}$ /NMI pin
1	OFIFG	RW	1h	Flag set on oscillator fault.
0	WDTIFG	RW	0h	Set on watchdog timer overflow (in watchdog mode) or security key violation. Reset on V_{CC} power on or a reset condition at the $\overline{\text{RST}}$ /NMI pin in reset mode.

Figure 6-5 shows the Interrupt Flag Register 2, and Table 6-7 describes the bit fields.

Figure 6-5. Interrupt Flag Register 2 (Address = 03h)

7	6	5	4	3	2	1	0
BTIFG							
rw-0							

Table 6-7. Interrupt Flag Register 2 Description

BIT	FIELD	TYPE	RESET	DESCRIPTION
7	BTIFG	RW	0h	Basic Timer1 interrupt flag

Figure 6-6 shows the Module Enable Register 1, and Table 6-8 describes the bit fields.

Figure 6-6. Module Enable Register 1 (Address = 04h)

7	6	5	4	3	2	1	0
UTXE0	URXE0 USPIE0						
rw-0	rw-0						

Table 6-8. Module Enable Register 1 Description

BIT	FIELD	TYPE	RESET	DESCRIPTION
7	UTXE0	RW	0h	USART0: UART mode transmit enable
6	URXE0 USPIE0	RW	0h	USART0: UART mode receive enable USART0: SPI mode transmit and receive enable

Module Enable Register 2 is not defined for the MSP430FE42x MCUs.

6.6 Memory Organization

Table 6-9 summarizes the memory map of the MSP430FE42x MCUs.

Table 6-9. Memory Organization

		MSP430FE423	MSP430FE425	MSP430FE427
Memory	Size	8KB	16KB	32KB
Interrupt vector	Flash	0FFFFh–0FFE0h	0FFFFh–0FFE0h	0FFFFh–0FFE0h
Code memory	Flash	0FFFFh–0E000h	0FFFFh–0C000h	0FFFFh–08000h
Information memory	Size	256 Byte	256 Byte	256 Byte
		010FFh–01000h	010FFh–01000h	010FFh–01000h
Boot memory	Size	1KB	1KB	1KB
		0FFFh–0C00h	0FFFh–0C00h	0FFFh–0C00h
RAM	Size	256 Byte	512 Byte	1KB
		02FFh–0200h	03FFh–0200h	05FFh–0200h
Peripherals	16-bit	01FFh–0100h	01FFh–0100h	01FFh–0100h
	8-bit	0FFh–010h	0FFh–010h	0FFh–010h
	8-bit SFR	0Fh–00h	0Fh–00h	0Fh–00h

6.7 Bootloader (BSL)

The MSP430 bootloader (BSL) enables users to program the flash memory or RAM using a UART serial interface. Access to the MSP430 memory through the BSL is protected by user-defined password. For complete description of the features of the BSL and its implementation, see [MSP430 Programming With the Bootloader \(BSL\)](#).

BSL FUNCTION	PM PACKAGE PINS
Data transmit	53 - P1.0
Data receiver	52 - P1.1

6.8 Flash Memory

The flash memory (see [Figure 6-7](#)) can be programmed using the JTAG port, the bootloader, or in system by the CPU. The CPU can perform single-byte and single-word writes to the flash memory. Features of the flash memory include:

- Flash memory has n segments of main memory and two segments of information memory (A and B) of 128 bytes each. Each segment in main memory is 512 bytes in size.
- Segments 0 to n may be erased in one step, or each segment may be individually erased.
- Segments A and B can be erased individually, or as a group with segments 0 to n. Segments A and B are also called *information memory*.
- New devices may have some bytes programmed in the information memory (needed for test during manufacturing). The user should perform an erase of the information memory before the first use.

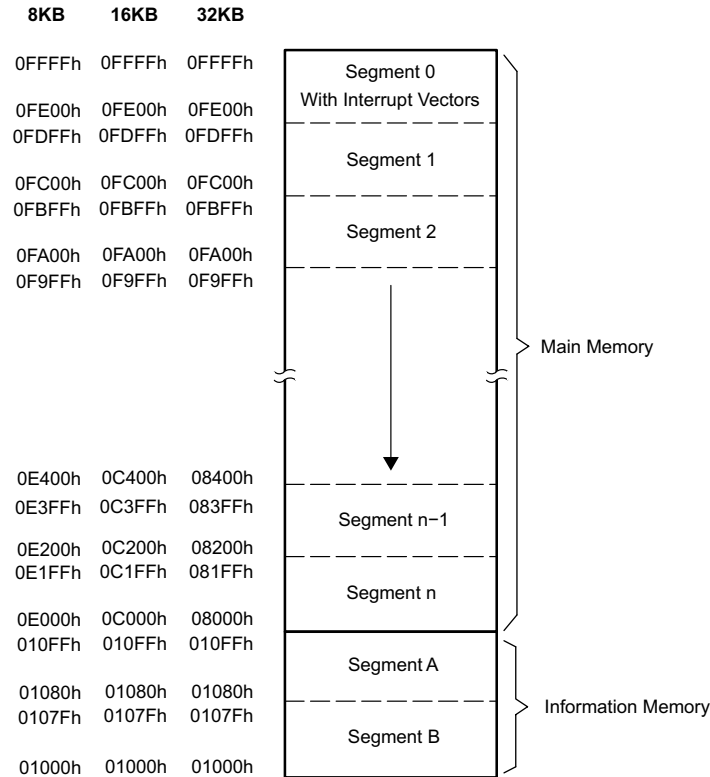

Figure 6-7. Flash Memory Map

6.9 Peripherals

Peripherals are connected to the CPU through data, address, and control buses. Peripherals can be managed using all instructions. For complete module descriptions, see the [MSP430x4xx Family User's Guide](#).

6.9.1 Oscillator and System Clock

The clock system is supported by the FLL+ module that includes support for a 32768-Hz watch crystal oscillator, an internal digitally controlled oscillator (DCO), and a high-frequency crystal oscillator. The FLL+ clock module is designed to meet the requirements of both low system cost and low power consumption. The FLL+ features digital frequency locked loop (FLL) hardware that, in conjunction with a digital modulator, stabilizes the DCO frequency to a programmable multiple of the watch crystal frequency. The internal DCO provides a fast turnon clock source and stabilizes in less than 6 μs. The FLL+ module provides the following clock signals:

- Auxiliary clock (ACLK), sourced from a 32768-Hz watch crystal or a high-frequency crystal
- Main clock (MCLK), the system clock used by the CPU
- Sub-Main clock (SMCLK), the subsystem clock used by the peripheral modules
- ACLK/n, the buffered output of ACLK, ACLK/2, ACLK/4, or ACLK/8

6.9.2 Brownout, Supply Voltage Supervisor (SVS)

The brownout circuit provides the proper internal reset signal to the device during power on and power off. The SVS circuitry detects if the supply voltage drops below a user-selectable level and supports both supply voltage supervision (the device is automatically reset) and supply voltage monitoring (the device is not automatically reset).

The CPU begins code execution after the brownout circuit releases the device reset. However, V_{CC} may not have ramped to $V_{CC(\min)}$ at that time. The user must ensure that the default FLL+ settings are not changed until V_{CC} reaches $V_{CC(\min)}$. If desired, the SVS circuit can be used to determine when V_{CC} reaches $V_{CC(\min)}$.

6.9.3 Digital I/O

Two I/O ports are implemented: ports P1 and P2 (only six P2 I/O signals are available on external pins).

- All individual I/O bits are independently programmable.
- Any combination of input, output, and interrupt conditions is possible.
- Edge-selectable interrupt input capability for all the eight bits of ports P1 and P2.
- Read/write access to port-control registers is supported by all instructions.

NOTE

Six bits of port P2 (P2.0 to P2.5) are available on external pins, but all control and data bits for port P2 are implemented.

6.9.4 Basic Timer1

The Basic Timer1 has two independent 8-bit timers that can be cascaded to form a 16-bit timer/counter. Both timers can be read and written by software. The Basic Timer1 can be used to generate periodic interrupts and clock for the LCD module.

6.9.5 LCD Drive

The LCD driver generates the segment and common signals required to drive an LCD display. The LCD controller has dedicated data memory to hold segment drive information. Common and segment signals are generated as defined by the mode. Static, 2-mux, 3-mux, and 4-mux LCDs are supported by this peripheral.

6.9.6 Watchdog Timer (WDT+)

The primary function of the WDT+ module is to perform a controlled system restart after a software problem occurs. If the selected time interval expires, a system reset is generated. If the watchdog function is not needed in an application, the module can be configured as an interval timer and can generate interrupts at selected time intervals.

6.9.7 Timer_A3

Timer_A3 is a 16-bit timer and counter with three capture/compare registers. Timer_A3 can support multiple capture/compares, PWM outputs, and interval timing (see [Table 6-10](#)). Timer_A3 also has extensive interrupt capabilities. Interrupts may be generated from the counter on overflow conditions and from each of the capture/compare registers.

Table 6-10. Timer_A3 Signal Connections

INPUT PIN NUMBER	DEVICE INPUT SIGNAL	MODULE INPUT NAME	MODULE BLOCK	MODULE OUTPUT SIGNAL	OUTPUT PIN NUMBER
48 - P1.5	TACLK	TACLK	Timer	NA	
	ACLK	ACLK			
	SMCLK	SMCLK			
48 - P1.5	$\overline{\text{TACLK}}$	INCLK			
53 - P1.0	TA0	CCI0A	CCR0	TA0	53 - P1.0
52 - P1.1	TA0	CCI0B			
	DV _{SS}	GND			
	DV _{CC}	V _{CC}			
51 - P1.2	TA1	CCI1A	CCR1	TA1	51 - P1.2
51 - P1.2	TA1	CCI1B			
	DV _{SS}	GND			
	DV _{CC}	V _{CC}			
45 - P2.0	TA2	CCI2A	CCR2	TA2	45 - P2.0
	ACLK (internal)	CCI2B			
	DV _{SS}	GND			
	DV _{CC}	V _{CC}			

6.9.8 USART0

The MSP430FE42x devices have one hardware universal synchronous/asynchronous receive transmit (USART0) peripheral module that is used for serial data communication. The USART supports synchronous SPI (3- or 4-pin) and asynchronous UART communication protocols, using double-buffered transmit and receive channels.

6.9.9 ESP430CE1

The ESP430CE1 module integrates a hardware multiplier, three independent 16-bit Sigma-Delta ADCs (SD16) and an embedded signal processor (ESP430). The ESP430CE1 module measures 2- or 3-wire single-phase energy and automatically calculates parameters which are made available to the MSP430 CPU. The module can be calibrated and initialized to accurately calculate energy, power factor, and other values for a wide range of metering sensor configurations.

6.9.10 Peripheral File Map

Table 6-11 and Table 6-12 list the peripheral registers with their addresses.

Table 6-11. Peripherals With Word Access

MODULE	REGISTER NAME	ACRONYM	ADDRESS
Watchdog	Watchdog timer control	WDTCTL	0120h
Timer_A3	Timer0_A interrupt vector	TA0IV	012Eh
	Timer0_A control	TACTL0	0160h
	Capture/compare control 0	TACCTL0	0162h
	Capture/compare control 1	TACCTL1	0164h
	Capture/compare control 2	TACCTL2	0166h
	Reserved		0168h
	Reserved		016Ah
	Reserved		016Ch
	Reserved		016Eh
	Timer_A counter	TA0R	0170h
	Capture/compare 0	TACCR0	0172h
	Capture/compare 1	TACCR1	0174h
	Capture/compare 2	TACCR2	0176h
	Reserved		0178h
	Reserved		017Ah
	Reserved		017Ch
Reserved		017Eh	
Hardware Multiplier ⁽¹⁾	Sum extend	SUMEXT	013Eh
	Result high word	RESHI	013Ch
	Result low word	RESLO	013Ah
	Second operand	OP2	0138h
	Multiply signed + accumulate/operand 1	MACS	0136h
	Multiply + accumulate/operand 1	MAC	0134h
	Multiply signed/operand 1	MPYS	0132h
	Multiply unsigned/operand 1	MPY	0130h
Flash	Flash control 3	FCTL3	012Ch
	Flash control 2	FCTL2	012Ah
	Flash control 1	FCTL1	0128h

(1) This module is contained within ESP430CE1. Registers are not accessible when ESP430 is active. ESP430 must be disabled or suspended to allow CPU access to these modules.

Table 6-11. Peripherals With Word Access (continued)

MODULE	REGISTER NAME	ACRONYM	ADDRESS
SD16 ⁽¹⁾ (also see Table 6-12)	General control	SD16CTL	0100h
	Channel 0 control	SD16CCTL0	0102h
	Channel 1 control	SD16CCTL1	0104h
	Channel 2 control	SD16CCTL2	0106h
	Reserved		0108h
	Reserved		010Ah
	Reserved		010Ch
	Reserved		010Eh
	Interrupt vector word	SD16IV	0110h
	Channel 0 conversion memory	SD16MEM0	0112h
	Channel 1 conversion memory	SD16MEM1	0114h
	Channel 2 conversion memory	SD16MEM2	0116h
	Reserved		0118h
	Reserved		011Ah
	Reserved		011Ch
	Reserved		011Eh
ESP430 (ESP430CE1)	ESP430 control	ESPCTL	0150h
	Mailbox control	MBCTL	0152h
	Mailbox in 0	MBIN0	0154h
	Mailbox in 1	MBIN1	0156h
	Mailbox out 0	MBOUT0	0158h
	Mailbox out 1	MBOUT1	015Ah
	ESP430 return value 0	RET0	01C0h
	⋮	⋮	⋮
	ESP430 return value 31	RET31	01FEh

Table 6-12. Peripherals With Byte Access

MODULE	REGISTER NAME	ACRONYM	ADDRESS
SD16 ⁽¹⁾ (also see Table 6-11)	Channel 0 input control	SD16INCTL0	0B0h
	Channel 1 input control	SD16INCTL1	0B1h
	Channel 2 input control	SD16INCTL2	0B2h
	Reserved		0B3h
	Reserved		0B4h
	Reserved		0B5h
	Reserved		0B6h
	Reserved		0B7h
	Channel 0 preload	SD16PRE0	0B8h
	Channel 1 preload	SD16PRE1	0B9h
	Channel 2 preload	SD16PRE2	0BAh
	Reserved		0BBh
	Reserved		0BCh
	Reserved		0BDh
	Reserved		0BEh
	Reserved		0BFh

(1) This module is contained within ESP430CE1. Registers are not accessible when ESP430 is active. ESP430 must be disabled or suspended to allow CPU access to these modules.

Table 6-12. Peripherals With Byte Access (continued)

MODULE	REGISTER NAME	ACRONYM	ADDRESS
LCD	LCD memory 20	LCDM20	0A4h
	⋮	⋮	⋮
	LCD memory 16	LCDM16	0A0h
	LCD memory 15	LCDM15	09Fh
	⋮	⋮	⋮
	LCD memory 1	LCDM1	091h
	LCD control and mode	LCDCTL	090h
USART0	Transmit buffer	U0TXBUF	077h
	Receive buffer	U0RXBUF	076h
	Baud rate 1	U0BR1	075h
	Baud rate 0	U0BR0	074h
	Modulation control	U0MCTL	073h
	Receive control	U0RCTL	072h
	Transmit control	U0TCTL	071h
	USART control	U0CTL	070h
Brownout, SVS	SVS control register	SVSCTL	056h
FLL+ Clock	FLL+ control 1	FLL_CTL1	054h
	FLL+ control 0	FLL_CTL0	053h
	System clock frequency control	SCFQCTL	052h
	System clock frequency integrator	SCFI1	051h
	System clock frequency integrator	SCFI0	050h
Basic Timer1	BT counter 2	BTCNT2	047h
	BT counter 1	BTCNT1	046h
	BT control	BTCTL	040h
Port P2	Port P2 selection	P2SEL	02Eh
	Port P2 interrupt enable	P2IE	02Dh
	Port P2 interrupt-edge select	P2IES	02Ch
	Port P2 interrupt flag	P2IFG	02Bh
	Port P2 direction	P2DIR	02Ah
	Port P2 output	P2OUT	029h
	Port P2 input	P2IN	028h
Port P1	Port P1 selection	P1SEL	026h
	Port P1 interrupt enable	P1IE	025h
	Port P1 interrupt-edge select	P1IES	024h
	Port P1 interrupt flag	P1IFG	023h
	Port P1 direction	P1DIR	022h
	Port P1 output	P1OUT	021h
	Port P1 input	P1IN	020h
Special Functions	SFR module enable 2	ME2	005h
	SFR module enable 1	ME1	004h
	SFR interrupt flag 2	IFG2	003h
	SFR interrupt flag 1	IFG1	002h
	SFR interrupt enable 2	IE2	001h
	SFR interrupt enable 1	IE1	000h

6.10 Input/Output Diagrams

6.10.1 Port P1 (P1.0 and P1.1) Input/Output With Schmitt Trigger

Figure 6-8 shows the port diagram. Table 6-13 summarizes the selection of the port function.

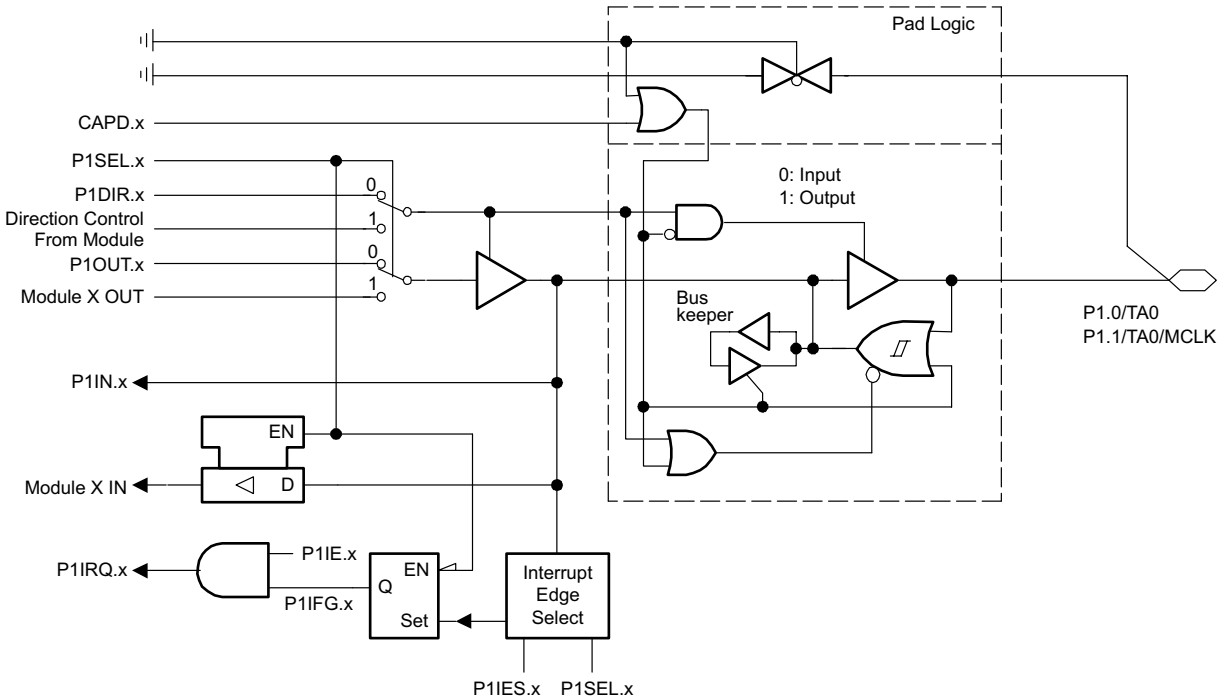

NOTE: $0 \leq x \leq 1$. Port function is active if CAPD.x = 0.

Figure 6-8. Port P1 (P1.0 and P1.1) Diagram

Table 6-13. Port P1 (P1.0 and P1.1) Pin Function

P1SEL.x	PnDIR.x	DIRECTION CONTROL FROM MODULE	P1OUT.x	MODULE X OUT	P1IN.x	MODULE X IN	P1IE.x	P1IFG.x	P1IES.x	CAPD.x
P1SEL.0	P1DIR.0	P1DIR.0	P1OUT.0	Out0 Sig. ⁽¹⁾	P1IN.0	CCI0A ⁽¹⁾	P1IE.0	P1IFG.0	P1IES.0	DVSS
P1SEL.1	P1DIR.1	P1DIR.1	P1OUT.1	MCLK	P1IN.1	CCI0B ⁽¹⁾	P1IE.1	P1IFG.1	P1IES.1	DVSS

(1) Timer_A3

6.10.2 Port P1 (P1.2 to P1.7) Input/Output With Schmitt Trigger

Figure 6-9 shows the port diagram. Table 6-14 summarizes the selection of the port function.

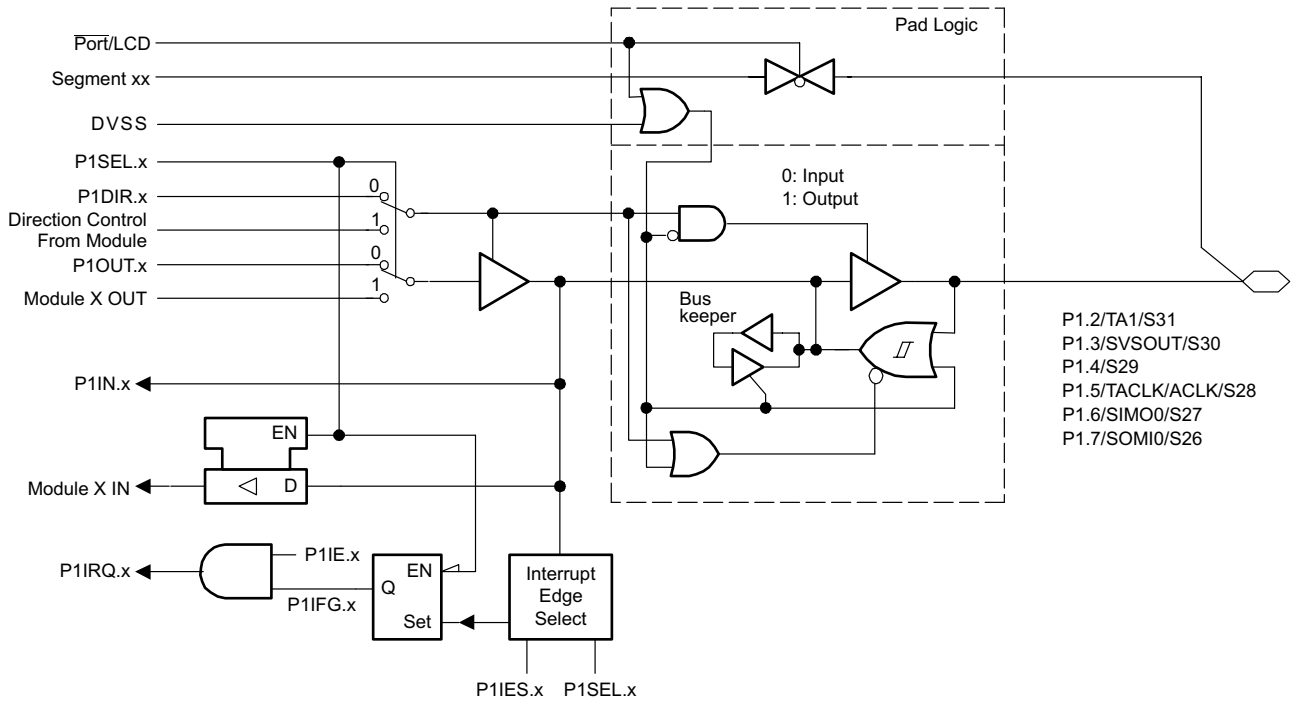

NOTE: $2 \leq x \leq 7$. Port function is active if $\overline{\text{Port/LCD}} = 0$.

Figure 6-9. Port P1 (P1.2 to P1.7) Diagram

Table 6-14. Port P1 (P1.2 to P1.7) Pin Functions

P1SEL.x	P1DIR.x	DIRECTION CONTROL FROM MODULE	P1OUT.x	MODULE X OUT	P1IN.x	MODULE X IN	P1IE.x	P1IFG.x	P1IES.x	$\overline{\text{Port/LCD}}$	SEGMENT
P1SEL.2	P1DIR.2	P1DIR.2	P1OUT.2	Out1 Sig. ⁽¹⁾	P1IN.2	CC1A†	P1IE.2	P1IFG.2	P1IES.2	0: LCDPx < 05h, 1: LCDPx ≥ 05h	S31
P1SEL.3	P1DIR.3	P1DIR.3	P1OUT.3	SVSOUT	P1IN.3	unused	P1IE.3	P1IFG.3	P1IES.3		S30
P1SEL.4	P1DIR.4	P1DIR.4	P1OUT.4	DVSS	P1IN.4	unused	P1IE.4	P1IFG.4	P1IES.4		S29
P1SEL.5	P1DIR.5	P1DIR.5	P1OUT.5	ACLK	P1IN.5	TACLK ⁽¹⁾	P1IE.5	P1IFG.5	P1IES.5	0: LCDPx < 04h, 1: LCDPx ≥ 04h	S28
P1SEL.6	P1DIR.6	DCM_SIMO	P1OUT.6	SIMO0(o) ⁽²⁾	P1IN.6	SIMO0(i) ⁽²⁾	P1IE.6	P1IFG.6	P1IES.6		S27
P1SEL.7	P1DIR.7	DCM_SOMI	P1OUT.7	SOMI0(o) ⁽²⁾	P1IN.7	SOMI0(i) ⁽²⁾	P1IE.7	P1IFG.7	P1IES.7	S26	

(1) Timer_A3

(2) USART0 (also see Figure 6-10)

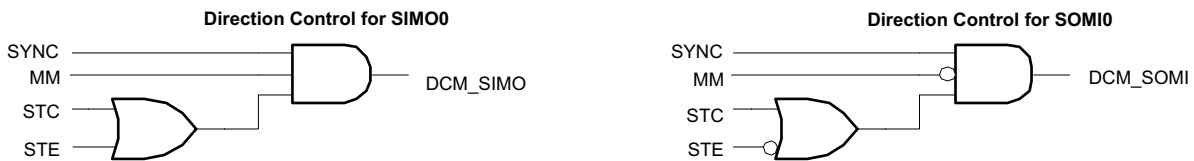

Figure 6-10. Direction Control for SIMO0 and SOMI0

6.10.4 Port P2 (P2.2 to P2.5) Input/Output With Schmitt Trigger

Figure 6-13 shows the port diagram. Table 6-16 summarizes the selection of the port function.

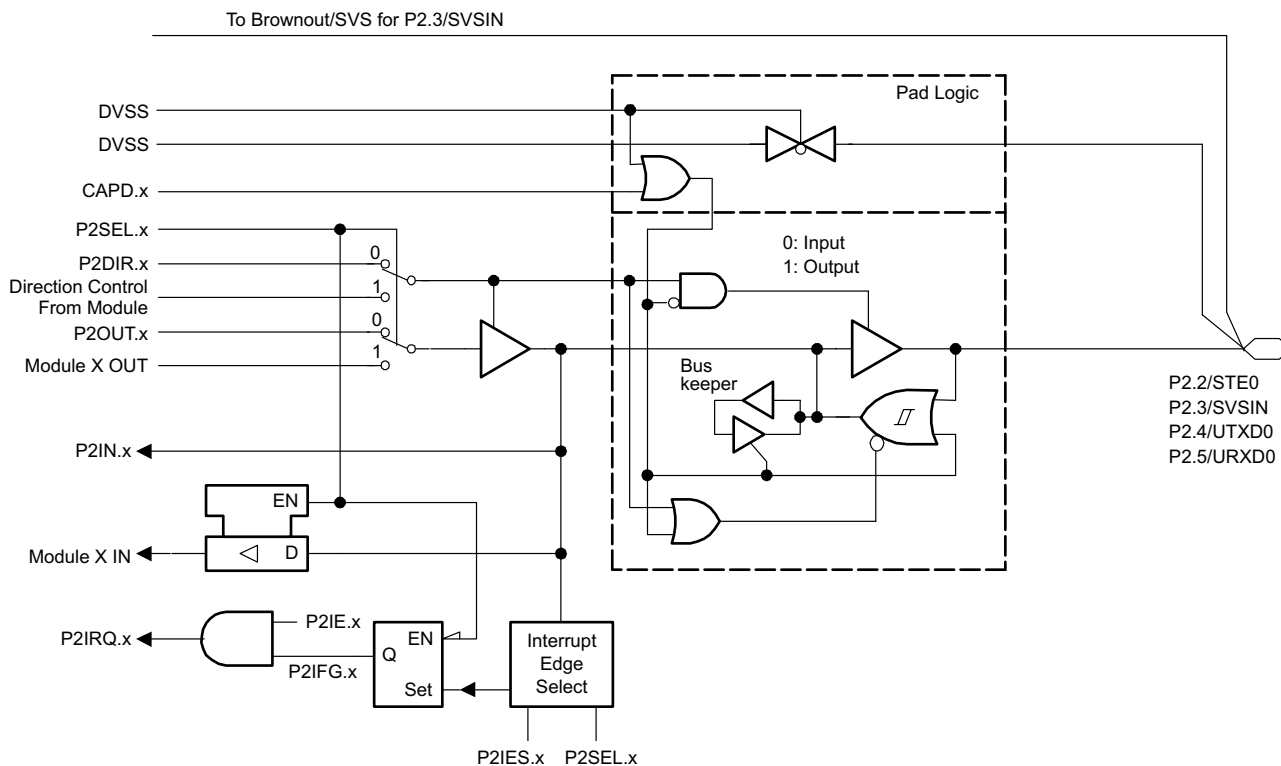

Figure 6-13. Port P2 (P2.2 to P2.5) Diagram

Table 6-16. Port P2 (P2.2 to P2.5) Pin Functions

P2SEL.x	P2DIR.x	DIRECTION CONTROL FROM MODULE	P2OUT.x	MODULE X OUT	P2IN.x	MODULE X IN	P2IE.x	P2IFG.x	P2IES.x	CAPD.x
P2SEL.2	P2DIR.2	DVSS	P2OUT.2	DVSS	P2IN.2	STE0 ⁽¹⁾	P2IE.2	P2IFG.2	P2IES.2	DVSS
P2SEL.3	P2DIR.3	P2DIR.3	P2OUT.3	DVSS	P2IN.3	Unused	P2IE.3	P2IFG.3	P2IES.3	SVSCTL VLD = 1111b
P2SEL.4	P2DIR.4	DVCC	P2OUT.4	UTXD0 ⁽¹⁾	P2IN.4	Unused	P2IE.4	P2IFG.4	P2IES.4	DVSS
P2SEL.5	P2DIR.5	DVSS	P2OUT.5	DVSS	P2IN.5	URXD0 ⁽¹⁾	P2IE.5	P2IFG.5	P2IES.5	DVSS

(1) USART0

6.10.5 Port P2 (P2.6 and P2.7) Unbonded GPIOs

Unbonded GPIOs P2.6 and P2.7 can be used as interrupt flags. Only software can affect the interrupt flags. They work as software interrupts.

Figure 6-14 shows the port diagram. Table 6-17 summarizes the selection of the port function.

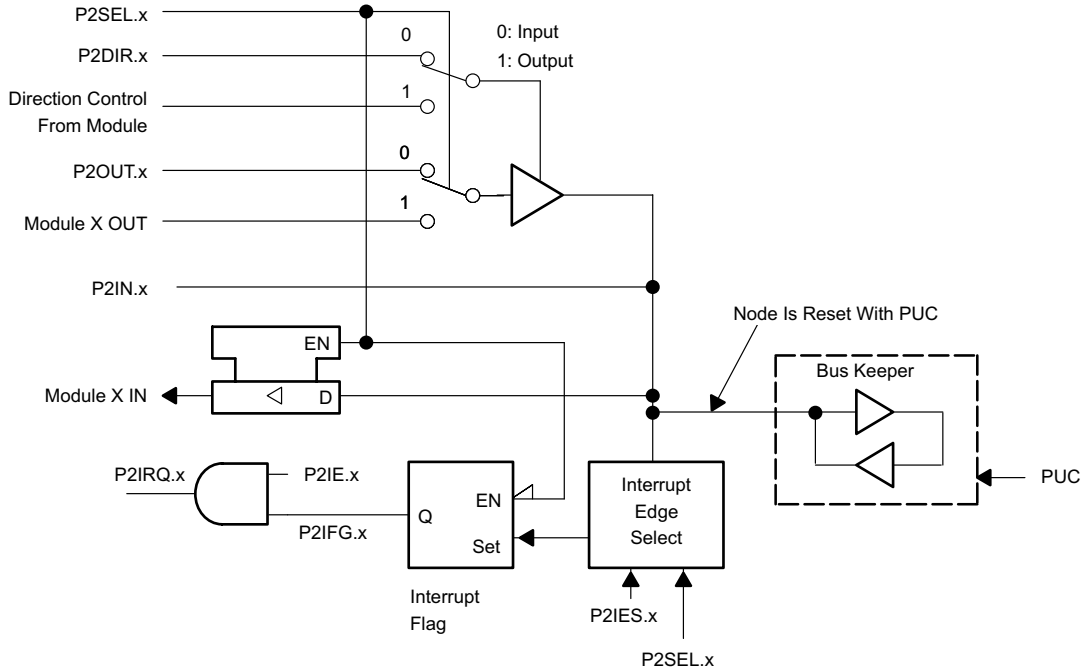

NOTE: x = Bit/identifier, 6 or 7 for Port P2 without external pins

Figure 6-14. Port P2 (P2.6 and P2.7) Diagram

Table 6-17. Port P2 (P2.6 and P2.7) Pin Functions

P2SEL.x	P2DIR.x	DIRECTION CONTROL FROM MODULE	P2OUT.x	MODULE X OUT	P2IN.x	MODULE X IN	P2IE.x	P2IFG.x	P2IES.x
P2SEL.6	P2DIR.6	P2DIR.6	P2OUT.6	DVSS	P2IN.6	Unused	P2IE.6	P2IFG.6	P2IES.6
P2SEL.7	P2DIR.7	P2DIR.7	P2OUT.7	DVSS	P2IN.7	Unused	P2IE.7	P2IFG.7	P2IES.7

6.10.6 JTAG Pins TMS, TCK, TDI/TCLK, TDO/TDI, Input/Output With Schmitt-Trigger or Output

Figure 6-15 shows the port diagram.

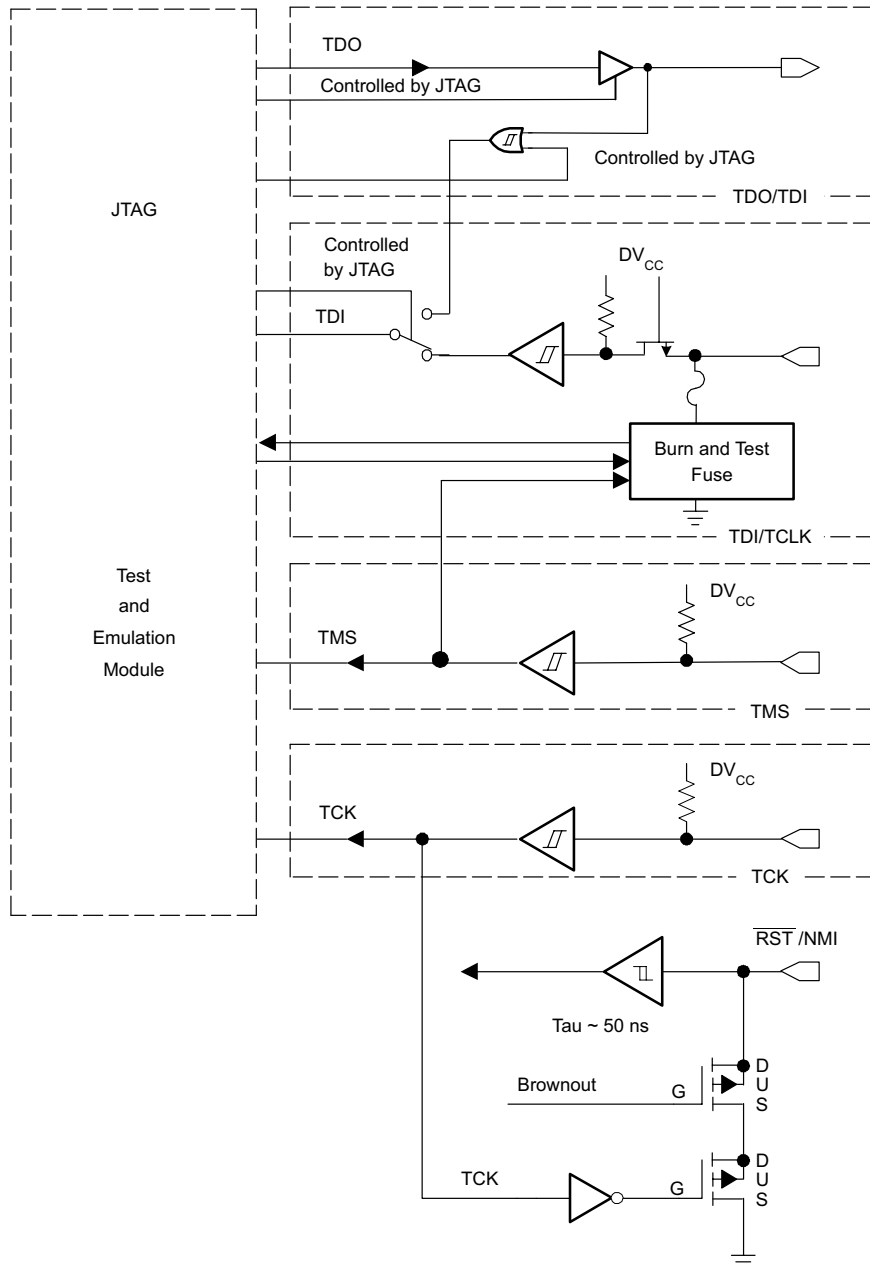

Figure 6-15. JTAG Pins Diagram

6.10.7 JTAG Fuse Check Mode

MSP430 devices that have the fuse on the TDI/TCLK terminal have a fuse check mode that tests the continuity of the fuse the first time the JTAG port is accessed after a power-on reset (POR). When activated, a fuse check current (I_{TF}) of 1.8 mA at 3 V can flow from the TDI/TCLK pin to ground if the fuse is not burned. Care must be taken to avoid accidentally activating the fuse check mode and increasing overall system power consumption.

Activation of the fuse check mode occurs with the first negative edge on the TMS pin after power up or if the TMS is being held low during power up. The second positive edge on the TMS pin deactivates the fuse check mode. After deactivation, the fuse check mode remains inactive until another POR occurs. After each POR the fuse check mode has the potential to be activated.

The fuse check current flows only when the fuse check mode is active and the TMS pin is in a low state (see Figure 6-16). Therefore, the additional current flow can be prevented by holding the TMS pin high (default condition). The JTAG pins are terminated internally and therefore do not require external termination.

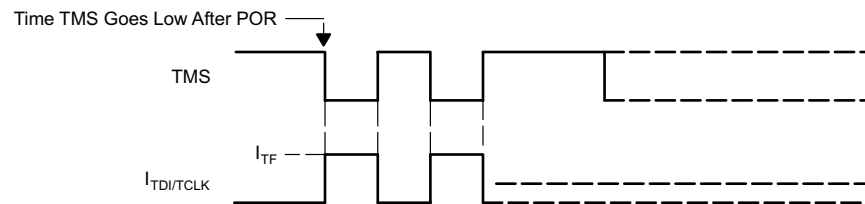

Figure 6-16. Fuse Check Mode Current

7 Device and Documentation Support

7.1 Getting Started and Next Steps

For more information on the MSP430 family of devices and the tools and libraries that are available to help with your development, visit the [Getting Started](#) page.

7.2 Device Nomenclature

To designate the stages in the product development cycle, TI assigns prefixes to the part numbers of all MSP430 MCU devices and support tools. Each MSP430 MCU commercial family member has one of three prefixes: MSP, PMS, or XMS. TI recommends two of three possible prefix designators for its support tools: MSP and MSPX. These prefixes represent evolutionary stages of product development from engineering prototypes (with XMS for devices and MSPX for tools) through fully qualified production devices and tools (with MSP for devices and MSP for tools).

Device development evolutionary flow:

XMS – Experimental device that is not necessarily representative of the final electrical specifications of the device

MSP – Fully qualified production device

Support tool development evolutionary flow:

MSPX – Development-support product that has not yet completed TI's internal qualification testing.

MSP – Fully-qualified development-support product

XMS devices and MSPX development-support tools are shipped against the following disclaimer:

"Developmental product is intended for internal evaluation purposes."

MSP devices and MSP development-support tools have been characterized fully, and the quality and reliability of the device have been demonstrated fully. TI's standard warranty applies.

Predictions show that prototype devices (XMS) have a greater failure rate than the standard production devices. TI recommends that these devices not be used in any production system because their expected end-use failure rate still is undefined. Only qualified production devices are to be used.

TI device nomenclature also includes a suffix with the device family name. This suffix indicates the package type (for example, PZP) and temperature range (for example, T). [Figure 7-1](#) provides a legend for reading the complete device name for any family member.

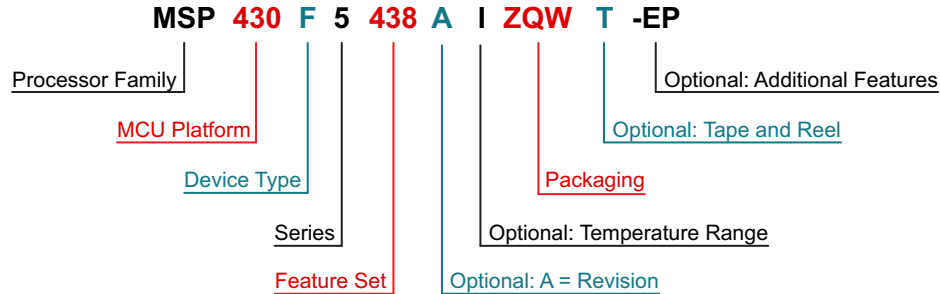

Processor Family	CC = Embedded RF Radio MSP = Mixed-Signal Processor XMS = Experimental Silicon PMS = Prototype Device	
MCU Platform	430 = MSP430 low-power microcontroller platform	
Device Type	Memory Type C = ROM F = Flash FR = FRAM G = Flash or FRAM (Value Line) L = No Nonvolatile Memory	Specialized Application AFE = Analog Front End BT = Preprogrammed with <i>Bluetooth</i> BQ = Contactless Power CG = ROM Medical FE = Flash Energy Meter FG = Flash Medical FW = Flash Electronic Flow Meter
Series	1 Series = Up to 8 MHz 2 Series = Up to 16 MHz 3 Series = Legacy 4 Series = Up to 16 MHz with LCD	5 Series = Up to 25 MHz 6 Series = Up to 25 MHz with LCD 0 = Low-Voltage Series
Feature Set	Various Levels of Integration Within a Series	
Optional: A = Revision	N/A	
Optional: Temperature Range	S = 0°C to 50°C C = 0°C to 70°C I = -40°C to 85°C T = -40°C to 105°C	
Packaging	http://www.ti.com/packaging	
Optional: Tape and Reel	T = Small Reel R = Large Reel No Markings = Tube or Tray	
Optional: Additional Features	-EP = Enhanced Product (-40°C to 105°C) -HT = Extreme Temperature Parts (-55°C to 150°C) -Q1 = Automotive Q100 Qualified	

NOTE: This figure does not represent a complete list of the available features and options, and it does not indicate that all of these features and options are available for a given device or family.

Figure 7-1. Device Nomenclature – Part Number Decoder

7.3 Tools and Software

Table 7-1 lists the debug features supported by the MSP430FE42x microcontrollers. See the [Code Composer Studio for MSP430 User's Guide](#) for details on the available features.

Table 7-1. Hardware Features

MSP430 ARCHITECTURE	4-WIRE JTAG	2-WIRE JTAG	BREAK-POINTS (N)	RANGE BREAK-POINTS	CLOCK CONTROL	STATE SEQUENCER	TRACE BUFFER
MSP430	Yes	No	3	No	Global	No	No

Design Kits and Evaluation Modules

64-pin Target Development Board and MSP-FET Programmer Bundle - MSP430F1x, MSP430F2x, MSP430F4x MCUs The MSP-FET430U64 is a powerful flash emulation tool that includes the hardware and software required to quickly begin application development on the MSP430 MCU. It includes a ZIF socket target board (MSP-TS430PM64) and a USB debugging interface (MSP-FET) used to program and debug the MSP430 in-system through the JTAG interface or the pin-saving Spy-Bi-Wire (2-wire JTAG) protocol. The flash memory can be erased and programmed in seconds with only a few keystrokes, and because the MSP430 flash is ultra-low power, no external power supply is required.

Software

MSP430x41x, MSP430F42x Code Examples C Code examples are available for every MSP device that configures each of the integrated peripherals for various application needs.

Capacitive Touch Software Library Free C libraries for enabling capacitive touch capabilities on MSP430 MCUs. The MSP430 MCU version of the library features several capacitive touch implementations including the RO and RC method.

MSPWare Software MSPWare software is a collection of code examples, data sheets, and other design resources for all MSP devices delivered in a convenient package. In addition to providing a complete collection of existing MSP design resources, MSPWare software also includes a high-level API called MSP Driver Library. This library makes it easy to program MSP hardware. MSPWare software is available as a component of CCS or as a stand-alone package.

MSP Driver Library The abstracted API of MSP Driver Library provides easy-to-use function calls that free you from directly manipulating the bits and bytes of the MSP430 hardware. Thorough documentation is delivered through a helpful API Guide, which includes details on each function call and the recognized parameters. Developers can use Driver Library functions to write complete projects with minimal overhead.

MSP EnergyTrace Technology EnergyTrace technology for MSP430 microcontrollers is an energy-based code analysis tool that measures and displays the energy profile of the application and helps to optimize it for ultra-low power consumption.

ULP (Ultra-Low Power) Advisor ULP Advisor™ software is a tool for guiding developers to write more efficient code to fully use the unique ultra-low-power features of MSP and MSP432 microcontrollers. Aimed at both experienced and new microcontroller developers, ULP Advisor checks your code against a thorough ULP checklist to help minimize the energy consumption of your application. At build time, ULP Advisor provides notifications and remarks to highlight areas of your code that can be further optimized for lower power.

Fixed Point Math Library for MSP The MSP IQmath and Qmath Libraries are a collection of highly optimized and high-precision mathematical functions for C programmers to seamlessly port a floating-point algorithm into fixed-point code on MSP430 and MSP432 devices. These routines are typically used in computationally intensive real-time applications where optimal execution speed, high accuracy, and ultra-low energy are critical. By using the IQmath and Qmath libraries, it is possible to achieve execution speeds considerably faster and energy consumption considerably lower than equivalent code written using floating-point math.

Development Tools

Code Composer Studio™ Integrated Development Environment for MSP Microcontrollers Code Composer Studio (CCS) integrated development environment (IDE) supports all MSP microcontroller devices. CCS comprises a suite of embedded software utilities used to develop and debug embedded applications. CCS includes an optimizing C/C++ compiler, source code editor, project build environment, debugger, profiler, and many other features.

MSPWare Software MSPWare software is a collection of code examples, data sheets, and other design resources for all MSP devices delivered in a convenient package. In addition to providing a complete collection of existing MSP design resources, MSPWare software also includes a high-level API called MSP Driver Library. This library makes it easy to program MSP hardware. MSPWare software is available as a component of CCS or as a stand-alone package.

Command-Line Programmer MSP Flasher is an open-source shell-based interface for programming MSP microcontrollers through a FET programmer or eZ430 using JTAG or Spy-Bi-Wire (SBW) communication. MSP Flasher can download binary files (.txt or .hex) directly to the MSP microcontroller without an IDE.

MSP MCU Programmer and Debugger The MSP-FET is a powerful emulation development tool – often called a debug probe – which lets users quickly begin application development on MSP low-power MCUs. Creating MCU software usually requires downloading the resulting binary program to the MSP device for validation and debugging.

MSP-GANG Production Programmer The MSP Gang Programmer is an MSP430 or MSP432 device programmer that can program up to eight identical MSP430 or MSP432 flash or FRAM devices at the same time. The MSP Gang Programmer connects to a host PC using a standard RS-232 or USB connection and provides flexible programming options that let the user fully customize the process.

7.4 Documentation Support

The following documents describe the MSP430FE42x MCUs. Copies of these documents are available on the Internet at www.ti.com.

Receiving Notification of Document Updates

To receive notification of documentation updates—including silicon errata—go to the product folder for your device on ti.com (see [Section 7.5](#) for links to product folders). In the upper right corner, click the "Alert me" button. This registers you to receive a weekly digest of product information that has changed (if any). For change details, check the revision history of any revised document.

Errata

MSP430FE427 Device Erratasheet Describes the known exceptions to the functional specifications for each silicon revision of this device.

MSP430FE425 Device Erratasheet Describes the known exceptions to the functional specifications for each silicon revision of this device.

MSP430FE423 Device Erratasheet Describes the known exceptions to the functional specifications for each silicon revision of this device.

User's Guides

MSP430x4xx Family User's Guide Detailed description of all modules and peripherals available in this device family.

ESP430CE1, ESP430CE1A, ESP430CE1B Peripheral Modules User's Guide The ESP430CE1/1A/1B module incorporates the SD16, hardware multiplier, and ESP430 embedded processor engine for use in single-phase energy metering applications.

Code Composer Studio v6.1 for MSP430 User's Guide This manual describes the use of TI Code Composer Studio IDE v6.1 (CCS v6.1) with the MSP430 ultra-low-power microcontrollers. This document applies only for the Windows® version of the Code Composer Studio IDE. The Linux® version is similar and, therefore, is not described separately.

IAR Embedded Workbench Version 3+ for MSP430 User's Guide This manual describes the use of IAR Embedded Workbench (EW430) with the MSP430 ultra-low-power microcontrollers.

MSP430 Programming With the JTAG Interface This document describes the functions that are required to erase, program, and verify the memory module of the MSP430 flash-based and FRAM-based microcontroller families using the JTAG communication port. In addition, it describes how to program the JTAG access security fuse that is available on all MSP430 devices. This document describes device access using both the standard 4-wire JTAG interface and the 2-wire JTAG interface, which is also referred to as Spy-Bi-Wire (SBW).

MSP430 Hardware Tools User's Guide This manual describes the hardware of the TI MSP-FET430 Flash Emulation Tool (FET). The FET is the program development tool for the MSP430 ultra-low-power microcontroller. Both available interface types, the parallel port interface and the USB interface, are described.

Application Reports

MSP430 32-kHz Crystal Oscillators Selection of the right crystal, correct load circuit, and proper board layout are important for a stable crystal oscillator. This application report summarizes crystal oscillator function and explains the parameters to select the correct crystal for MSP430 ultra-low-power operation. In addition, hints and examples for correct board layout are given. The document also contains detailed information on the possible oscillator tests to ensure stable oscillator operation in mass production.

MSP430 System-Level ESD Considerations System-Level ESD has become increasingly demanding with silicon technology scaling towards lower voltages and the need for designing cost-effective and ultra-low-power components. This application report addresses three different ESD topics to help board designers and OEMs understand and design robust system-level designs.

Designing With MSP430 and Segment LCDs Segment liquid crystal displays (LCDs) are needed to provide information to users in a wide variety of applications from smart meters to electronic shelf labels (ESL) to medical equipment. Several MSP430™ microcontroller families include built-in low-power LCD driver circuitry that allows the MSP430 MCU to directly control the segmented LCD glass. This application note helps explain how segmented LCDs work, the different features of the various LCD modules across the MSP430 MCU family, LCD hardware layout tips, guidance on writing efficient and easy-to-use LCD driver software, and an overview of the portfolio of MSP430 devices that include different LCD features to aid in device selection.

Understanding MSP430 Flash Data Retention The MSP430 family of microcontrollers, as part of its broad portfolio, offers both read-only memory (ROM)-based and flash-based devices. Understanding the MSP430 flash is extremely important for efficient, robust, and reliable system design. Data retention is one of the key aspects to flash reliability. In this application report, data retention for the MSP430 flash is discussed in detail and the effect of temperature is given primary importance.

Interfacing the 3-V MSP430 to 5-V Circuits The interfacing of the 3-V MSP430x1xx and MSP430x4xx microcontroller families to circuits with a supply of 5 V or higher is shown. Input, output and I/O interfaces are given and explained. Worst-case design equations are provided, where necessary. Some simple power supplies generating both voltages are shown, too.

Implementing An Electronic Watt-Hour Meter With MSP430FE42x(A)/FE42x2 This report shows how to implement an electronic watt-hour meter with the MSP430FE42x(A)/FE42x2 devices. It contains guidelines and recommendations for use of the MSP430FE42x(A) and MSP430FE42x2 devices. In addition, a reference board with hardware details and software examples are included.

Efficient Multiplication and Division Using MSP430 Multiplication and division in the absence of a hardware multiplier require many instruction cycles, especially in C. This report discusses a method that does not need a hardware multiplier and can perform multiplication and division with only shift and add instructions. The method described in this application report is based on Horner's method.

7.5 Related Links

[Table 7-2](#) lists quick access links. Categories include technical documents, support and community resources, tools and software, and quick access to sample or buy.

Table 7-2. Related Links

PARTS	PRODUCT FOLDER	SAMPLE & BUY	TECHNICAL DOCUMENTS	TOOLS & SOFTWARE	SUPPORT & COMMUNITY
MSP430FE427	Click here	Click here	Click here	Click here	Click here
MSP430FE425	Click here	Click here	Click here	Click here	Click here
MSP430FE423	Click here	Click here	Click here	Click here	Click here

7.6 Community Resources

The following links connect to TI community resources. Linked contents are provided "AS IS" by the respective contributors. They do not constitute TI specifications and do not necessarily reflect TI's views; see TI's [Terms of Use](#).

[TI E2E™ Community](#)

TI's Engineer-to-Engineer (E2E) Community. Created to foster collaboration among engineers. At e2e.ti.com, you can ask questions, share knowledge, explore ideas, and help solve problems with fellow engineers.

[TI Embedded Processors Wiki](#)

Texas Instruments Embedded Processors Wiki. Established to help developers get started with embedded processors from Texas Instruments and to foster innovation and growth of general knowledge about the hardware and software surrounding these devices.

7.7 Trademarks

MSP430, ULP Advisor, Code Composer Studio, E2E are trademarks of Texas Instruments.

Linux is a registered trademark of Linus Torvalds.

Windows is a registered trademark of Microsoft Corporation.

7.8 Electrostatic Discharge Caution



This integrated circuit can be damaged by ESD. Texas Instruments recommends that all integrated circuits be handled with appropriate precautions. Failure to observe proper handling and installation procedures can cause damage.

ESD damage can range from subtle performance degradation to complete device failure. Precision integrated circuits may be more susceptible to damage because very small parametric changes could cause the device not to meet its published specifications.

7.9 Export Control Notice

Recipient agrees to not knowingly export or re-export, directly or indirectly, any product or technical data (as defined by the U.S., EU, and other Export Administration Regulations) including software, or any controlled product restricted by other applicable national regulations, received from disclosing party under nondisclosure obligations (if any), or any direct product of such technology, to any destination to which such export or re-export is restricted or prohibited by U.S. or other applicable laws, without obtaining prior authorization from U.S. Department of Commerce and other competent Government authorities to the extent required by those laws.

7.10 Glossary

[TI Glossary](#) This glossary lists and explains terms, acronyms, and definitions.

8 Mechanical, Packaging, and Orderable Information

The following pages include mechanical, packaging, and orderable information. This information is the most current data available for the designated devices. This data is subject to change without notice and revision of this document. For browser-based versions of this data sheet, refer to the left-hand navigation.

PACKAGING INFORMATION

Orderable Device	Status (1)	Package Type	Package Drawing	Pins	Package Qty	Eco Plan (2)	Lead finish/ Ball material (6)	MSL Peak Temp (3)	Op Temp (°C)	Device Marking (4/5)	Samples
MSP430FE423IPM	ACTIVE	LQFP	PM	64	160	RoHS & Green	NIPDAU	Level-3-260C-168 HR	-40 to 85	M430FE423	Samples
MSP430FE423IPMR	ACTIVE	LQFP	PM	64	1000	RoHS & Green	NIPDAU	Level-3-260C-168 HR	-40 to 85	M430FE423	Samples
MSP430FE425IPM	ACTIVE	LQFP	PM	64	160	RoHS & Green	NIPDAU	Level-3-260C-168 HR	-40 to 85	M430FE425	Samples
MSP430FE425IPMR	ACTIVE	LQFP	PM	64	1000	RoHS & Green	NIPDAU	Level-3-260C-168 HR	-40 to 85	M430FE425	Samples
MSP430FE427IPM	ACTIVE	LQFP	PM	64	160	RoHS & Green	NIPDAU	Level-3-260C-168 HR	-40 to 85	M430FE427	Samples
MSP430FE427IPMR	ACTIVE	LQFP	PM	64	1000	RoHS & Green	NIPDAU	Level-3-260C-168 HR	-40 to 85	M430FE427	Samples

(1) The marketing status values are defined as follows:

ACTIVE: Product device recommended for new designs.

LIFEBUY: TI has announced that the device will be discontinued, and a lifetime-buy period is in effect.

NRND: Not recommended for new designs. Device is in production to support existing customers, but TI does not recommend using this part in a new design.

PREVIEW: Device has been announced but is not in production. Samples may or may not be available.

OBSOLETE: TI has discontinued the production of the device.

(2) **RoHS:** TI defines "RoHS" to mean semiconductor products that are compliant with the current EU RoHS requirements for all 10 RoHS substances, including the requirement that RoHS substance do not exceed 0.1% by weight in homogeneous materials. Where designed to be soldered at high temperatures, "RoHS" products are suitable for use in specified lead-free processes. TI may reference these types of products as "Pb-Free".

RoHS Exempt: TI defines "RoHS Exempt" to mean products that contain lead but are compliant with EU RoHS pursuant to a specific EU RoHS exemption.

Green: TI defines "Green" to mean the content of Chlorine (Cl) and Bromine (Br) based flame retardants meet JS709B low halogen requirements of <=1000ppm threshold. Antimony trioxide based flame retardants must also meet the <=1000ppm threshold requirement.

(3) MSL, Peak Temp. - The Moisture Sensitivity Level rating according to the JEDEC industry standard classifications, and peak solder temperature.

(4) There may be additional marking, which relates to the logo, the lot trace code information, or the environmental category on the device.

(5) Multiple Device Markings will be inside parentheses. Only one Device Marking contained in parentheses and separated by a "~" will appear on a device. If a line is indented then it is a continuation of the previous line and the two combined represent the entire Device Marking for that device.

(6) Lead finish/Ball material - Orderable Devices may have multiple material finish options. Finish options are separated by a vertical ruled line. Lead finish/Ball material values may wrap to two lines if the finish value exceeds the maximum column width.

Important Information and Disclaimer: The information provided on this page represents TI's knowledge and belief as of the date that it is provided. TI bases its knowledge and belief on information provided by third parties, and makes no representation or warranty as to the accuracy of such information. Efforts are underway to better integrate information from third parties. TI has taken and continues to take reasonable steps to provide representative and accurate information but may not have conducted destructive testing or chemical analysis on incoming materials and chemicals. TI and TI suppliers consider certain information to be proprietary, and thus CAS numbers and other limited information may not be available for release.

In no event shall TI's liability arising out of such information exceed the total purchase price of the TI part(s) at issue in this document sold by TI to Customer on an annual basis.

TAPE AND REEL INFORMATION

QUADRANT ASSIGNMENTS FOR PIN 1 ORIENTATION IN TAPE



*All dimensions are nominal

Device	Package Type	Package Drawing	Pins	SPQ	Reel Diameter (mm)	Reel Width W1 (mm)	A0 (mm)	B0 (mm)	K0 (mm)	P1 (mm)	W (mm)	Pin1 Quadrant
MSP430FE423IPMR	LQFP	PM	64	1000	330.0	24.4	13.0	13.0	2.1	16.0	24.0	Q2
MSP430FE425IPMR	LQFP	PM	64	1000	330.0	24.4	13.0	13.0	2.1	16.0	24.0	Q2
MSP430FE427IPMR	LQFP	PM	64	1000	330.0	24.4	13.0	13.0	2.1	16.0	24.0	Q2

TAPE AND REEL BOX DIMENSIONS

*All dimensions are nominal

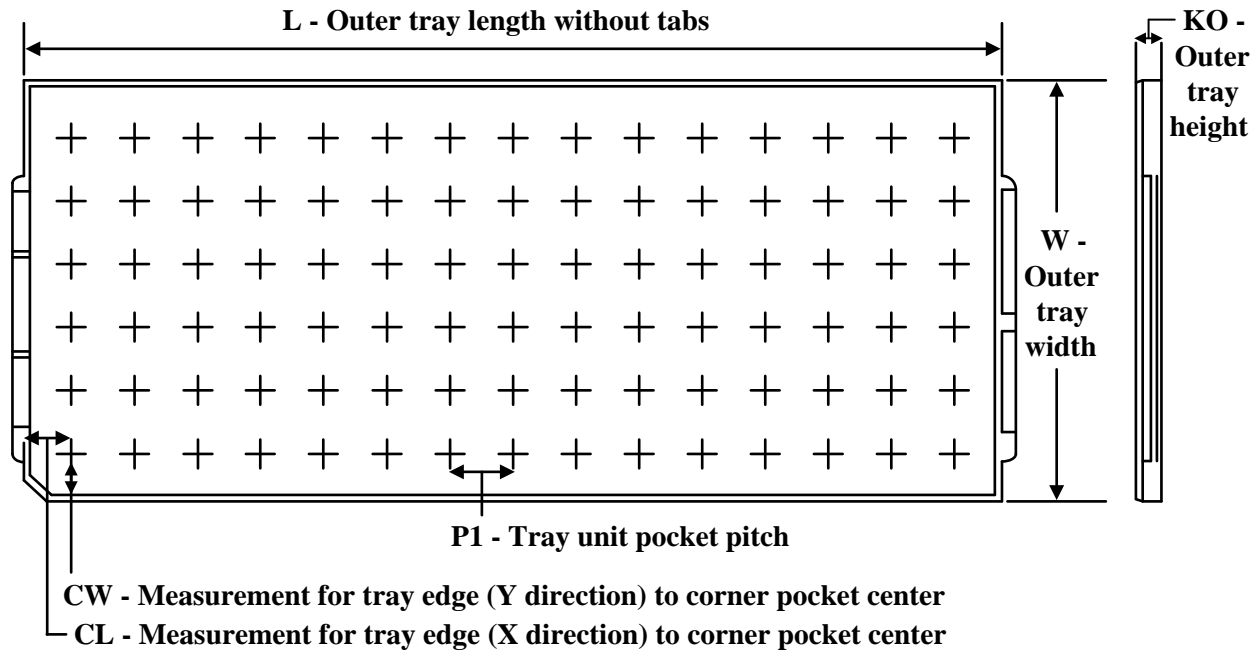
Device	Package Type	Package Drawing	Pins	SPQ	Length (mm)	Width (mm)	Height (mm)
MSP430FE423IPMR	LQFP	PM	64	1000	336.6	336.6	41.3
MSP430FE425IPMR	LQFP	PM	64	1000	336.6	336.6	41.3
MSP430FE427IPMR	LQFP	PM	64	1000	336.6	336.6	41.3

TRAY

Chamfer on Tray corner indicates Pin 1 orientation of packed units.

*All dimensions are nominal

Device	Package Name	Package Type	Pins	SPQ	Unit array matrix	Max temperature (°C)	L (mm)	W (mm)	K0 (µm)	P1 (mm)	CL (mm)	CW (mm)
MSP430FE423IPM	PM	LQFP	64	160	8 X 20	150	315	135.9	7620	15.2	13.1	13
MSP430FE423IPM	PM	LQFP	64	160	8 x 20	150	315	135.9	7620	15.2	13.1	13
MSP430FE425IPM	PM	LQFP	64	160	8 x 20	150	315	135.9	7620	15.2	13.1	13
MSP430FE425IPM	PM	LQFP	64	160	8 X 20	150	315	135.9	7620	15.2	13.1	13
MSP430FE427IPM	PM	LQFP	64	160	8 X 20	150	315	135.9	7620	15.2	13.1	13
MSP430FE427IPM	PM	LQFP	64	160	8 x 20	150	315	135.9	7620	15.2	13.1	13

PM0064A



PACKAGE OUTLINE

LQFP - 1.6 mm max height

PLASTIC QUAD FLATPACK

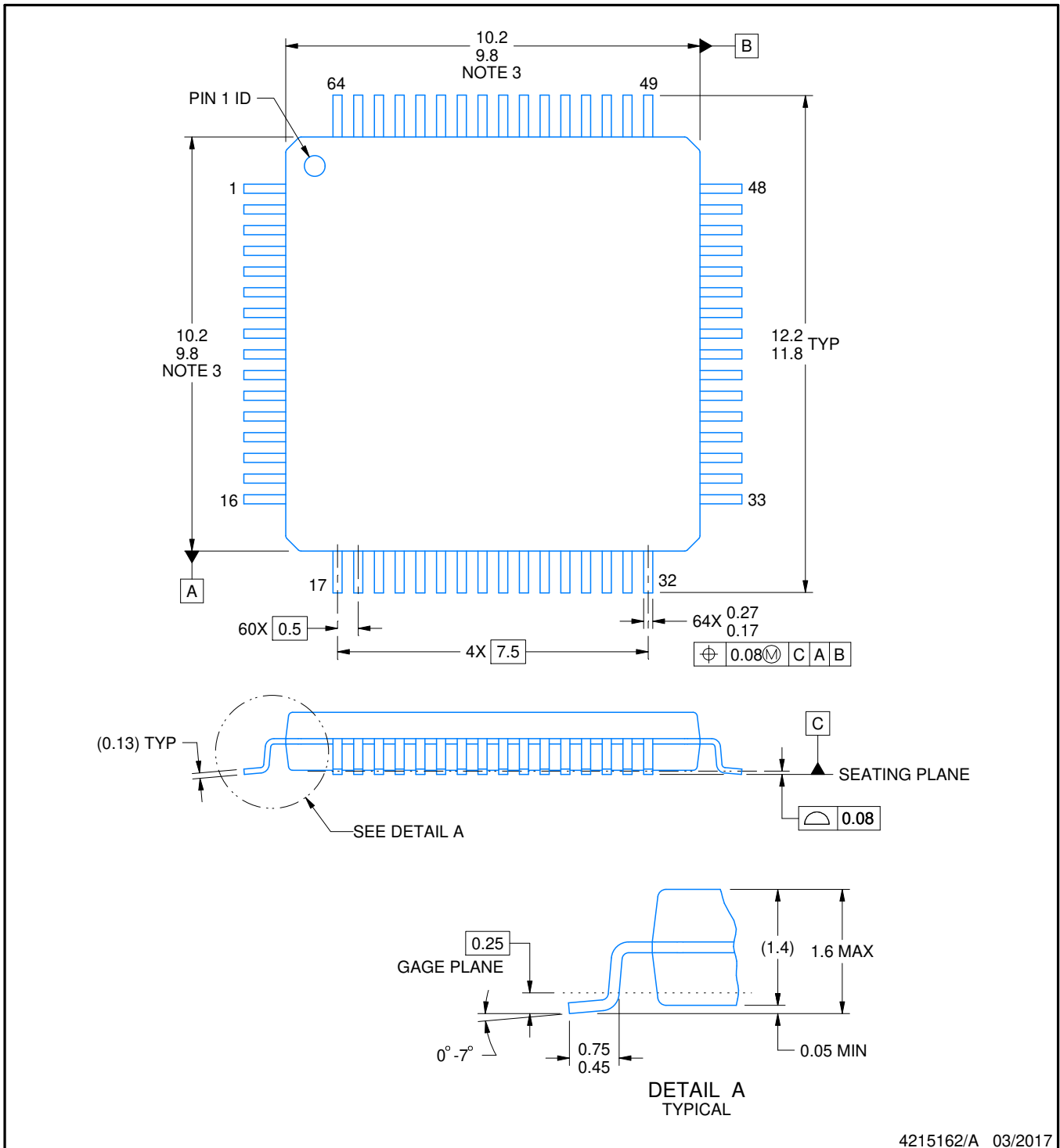

NOTES:

1. All linear dimensions are in millimeters. Any dimensions in parenthesis are for reference only. Dimensioning and tolerancing per ASME Y14.5M.
2. This drawing is subject to change without notice.
3. This dimension does not include mold flash, protrusions, or gate burrs. Mold flash, protrusions, or gate burrs shall not exceed 0.15 mm per side.
4. Reference JEDEC registration MS-026.

EXAMPLE BOARD LAYOUT

PM0064A

LQFP - 1.6 mm max height

PLASTIC QUAD FLATPACK

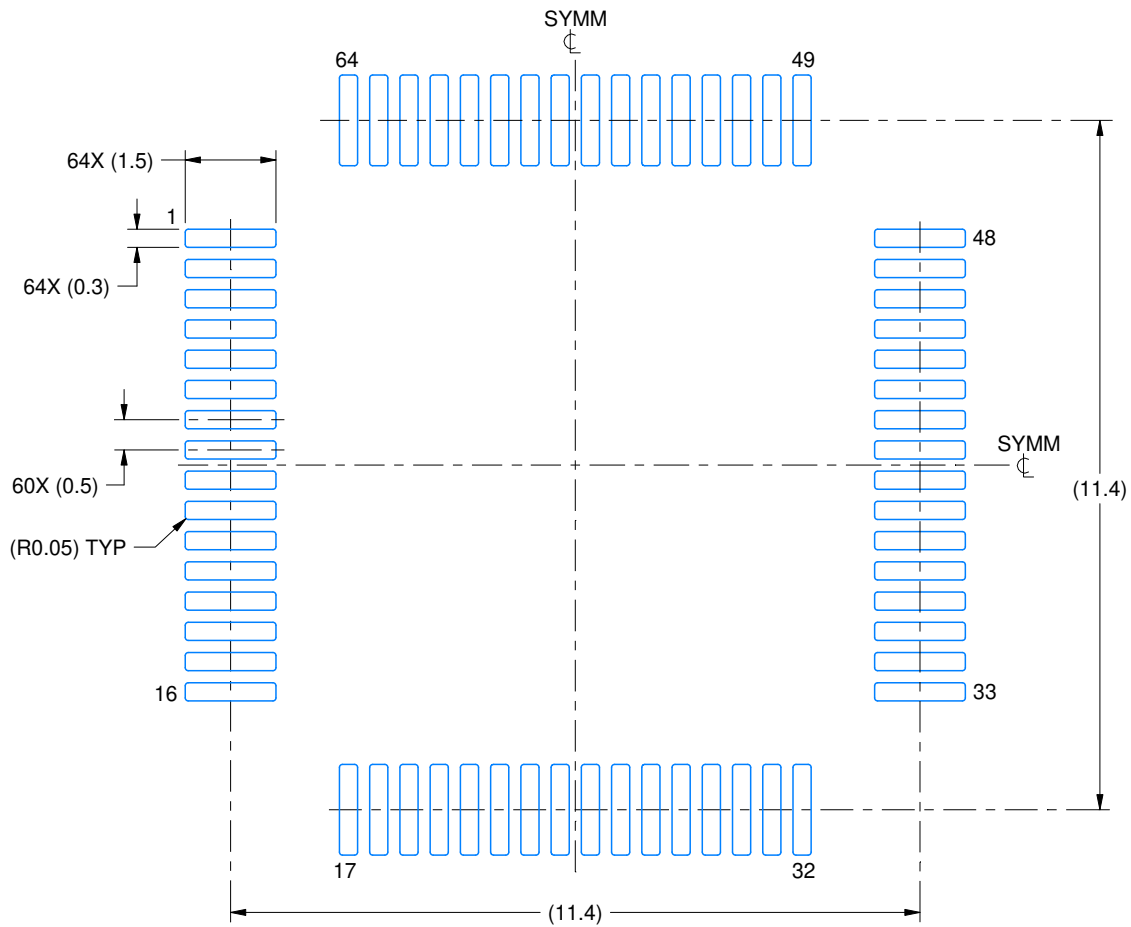

LAND PATTERN EXAMPLE
EXPOSED METAL SHOWN
SCALE:8X

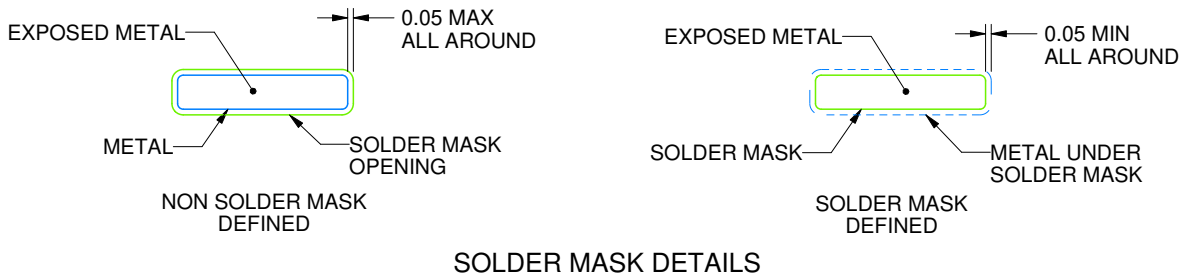

SOLDER MASK DETAILS

4215162/A 03/2017

NOTES: (continued)

5. Publication IPC-7351 may have alternate designs.
6. Solder mask tolerances between and around signal pads can vary based on board fabrication site.
7. For more information, see Texas Instruments literature number SLMA004 (www.ti.com/lit/slma004).

EXAMPLE STENCIL DESIGN

PM0064A

LQFP - 1.6 mm max height

PLASTIC QUAD FLATPACK

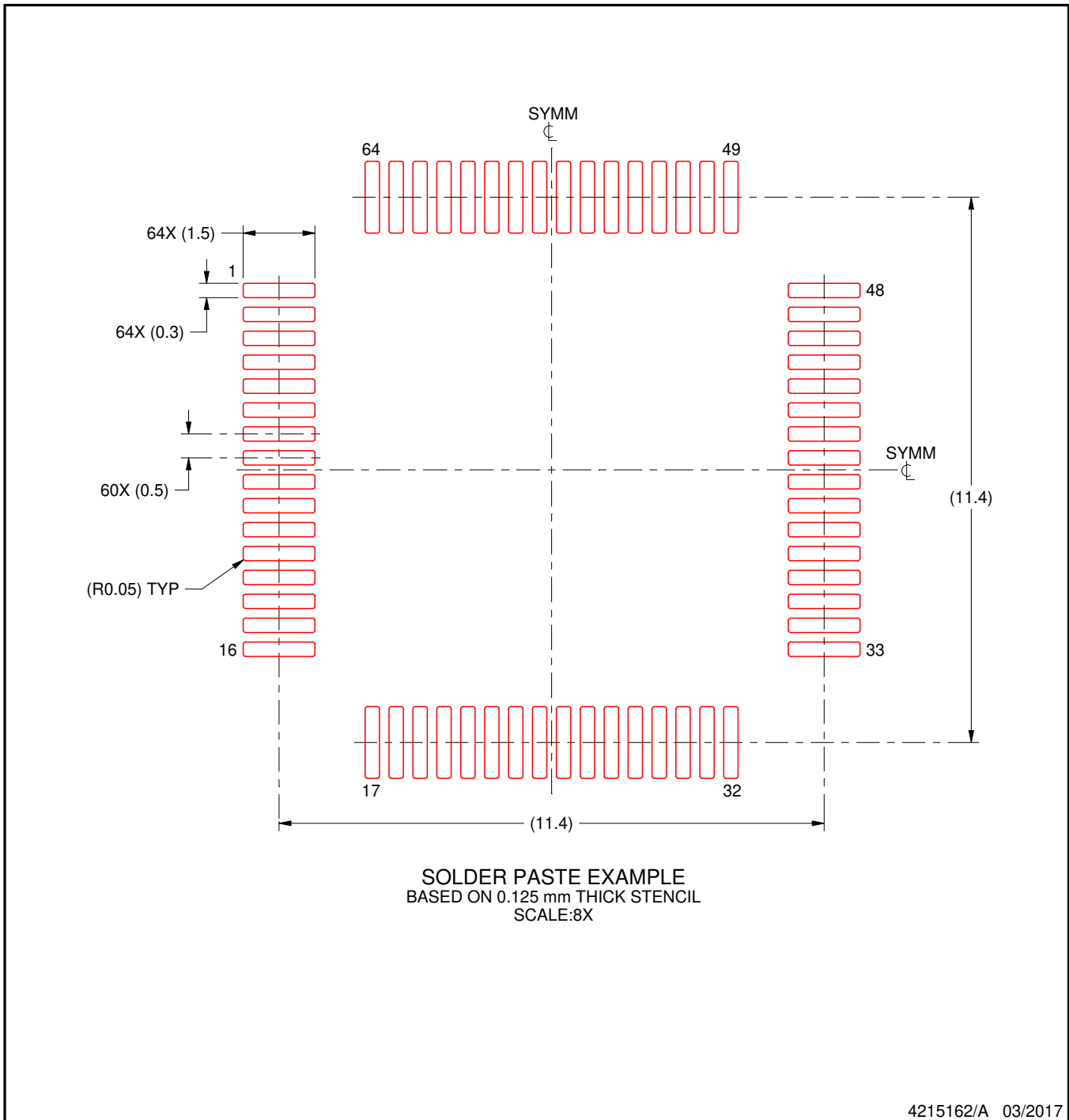

NOTES: (continued)

8. Laser cutting apertures with trapezoidal walls and rounded corners may offer better paste release. IPC-7525 may have alternate design recommendations.
9. Board assembly site may have different recommendations for stencil design.

IMPORTANT NOTICE AND DISCLAIMER

TI PROVIDES TECHNICAL AND RELIABILITY DATA (INCLUDING DATA SHEETS), DESIGN RESOURCES (INCLUDING REFERENCE DESIGNS), APPLICATION OR OTHER DESIGN ADVICE, WEB TOOLS, SAFETY INFORMATION, AND OTHER RESOURCES "AS IS" AND WITH ALL FAULTS, AND DISCLAIMS ALL WARRANTIES, EXPRESS AND IMPLIED, INCLUDING WITHOUT LIMITATION ANY IMPLIED WARRANTIES OF MERCHANTABILITY, FITNESS FOR A PARTICULAR PURPOSE OR NON-INFRINGEMENT OF THIRD PARTY INTELLECTUAL PROPERTY RIGHTS.

These resources are intended for skilled developers designing with TI products. You are solely responsible for (1) selecting the appropriate TI products for your application, (2) designing, validating and testing your application, and (3) ensuring your application meets applicable standards, and any other safety, security, regulatory or other requirements.

These resources are subject to change without notice. TI grants you permission to use these resources only for development of an application that uses the TI products described in the resource. Other reproduction and display of these resources is prohibited. No license is granted to any other TI intellectual property right or to any third party intellectual property right. TI disclaims responsibility for, and you will fully indemnify TI and its representatives against, any claims, damages, costs, losses, and liabilities arising out of your use of these resources.

TI's products are provided subject to [TI's Terms of Sale](#) or other applicable terms available either on [ti.com](https://www.ti.com) or provided in conjunction with such TI products. TI's provision of these resources does not expand or otherwise alter TI's applicable warranties or warranty disclaimers for TI products.

TI objects to and rejects any additional or different terms you may have proposed.

Mailing Address: Texas Instruments, Post Office Box 655303, Dallas, Texas 75265
Copyright © 2023, Texas Instruments Incorporated