

## TLV40x1 Small-Size, Low-Power Comparator with Precision Reference

### 1 Features

- Wide supply voltage range: 1.6 V to 5.5 V
- Precision References: 0.2 V, 0.5 V, and 1.2 V
- Fixed threshold of 3.2 V
- Reference accuracy
  - 0.5% at 25°C
  - 1% over temperature
- Low quiescent current: 2  $\mu$ A
- Propagation delay: 360 ns
- Push-pull and open-drain output options
- Known startup conditions
- Non-inverting and inverting input options
- Precision hysteresis
- Temperature range: –40°C to +125°C
- Packages:
  - 0.73 mm  $\times$  0.73 mm DSBGA (4-bump)
  - SOT-23 (5-pin)

### 2 Applications

- Self-diagnostics
- Lithium ion battery monitoring
- Battery management and protection
- Current and voltage sensing
- Analog front end
- Power management
- Point of load regulators
- DC/DC and AC/DC power supplies
- System control and monitoring

### 3 Description

The TLV40x1 devices are low-power, high-accuracy comparators with precision references and fast response. The comparators are available in an ultra-small, DSBGA package measuring 0.73 mm  $\times$  0.73 mm, making the TLV40x1 applicable for space-critical designs like portable or battery-powered electronics where low-power and fast response to changes in operating conditions is required.

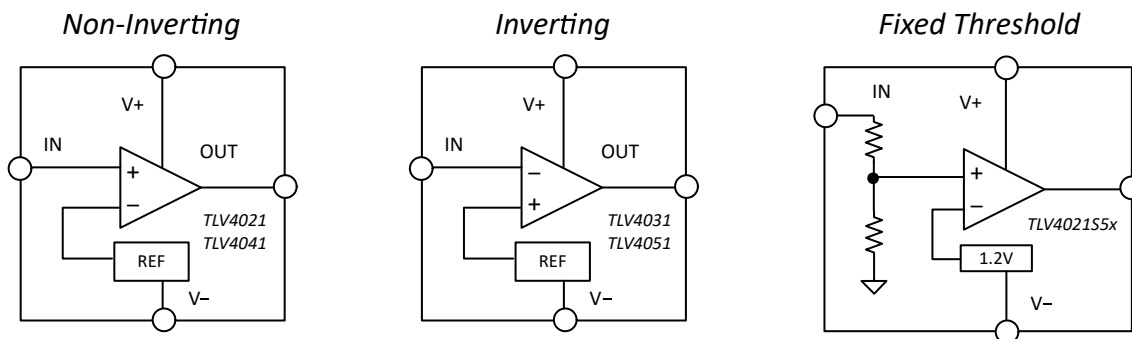
The factory-trimmed references and precision hysteresis combine to make the TLV40x1 appropriate for voltage and current monitoring in harsh, noisy environments where slow moving input signals must be converted into clean digital outputs. Similarly, brief glitches on the input are rejected ensuring stable output operation without false triggering.

The TLV40x1 are available in multiple configurations allowing system designers to achieve their desired output response. For example, the TLV4021 and TLV4041 offer a non-inverting input, while the TLV4031 and TLV4051 have an inverting input. Furthermore, the TLV4021 and TLV4031 feature an open-drain output stage, while the TLV4041 and TLV4051 feature a push-pull output stage. Lastly, each comparator in the TLV40x1 family is available with a 0.2V, 0.5V, or 1.2V precision reference.

#### Device Information

PART NUMBER	PACKAGE (1)	BODY SIZE (NOM)
TLV4021, TLV4031, TLV4041, TLV4051	DSBGA (4)	0.73 mm $\times$ 0.73 mm
TLV4041, TLV4051	SOT-23 (5)	2.9 mm $\times$ 1.6 mm

(1) For all available packages, see the orderable addendum at the end of the data sheet.



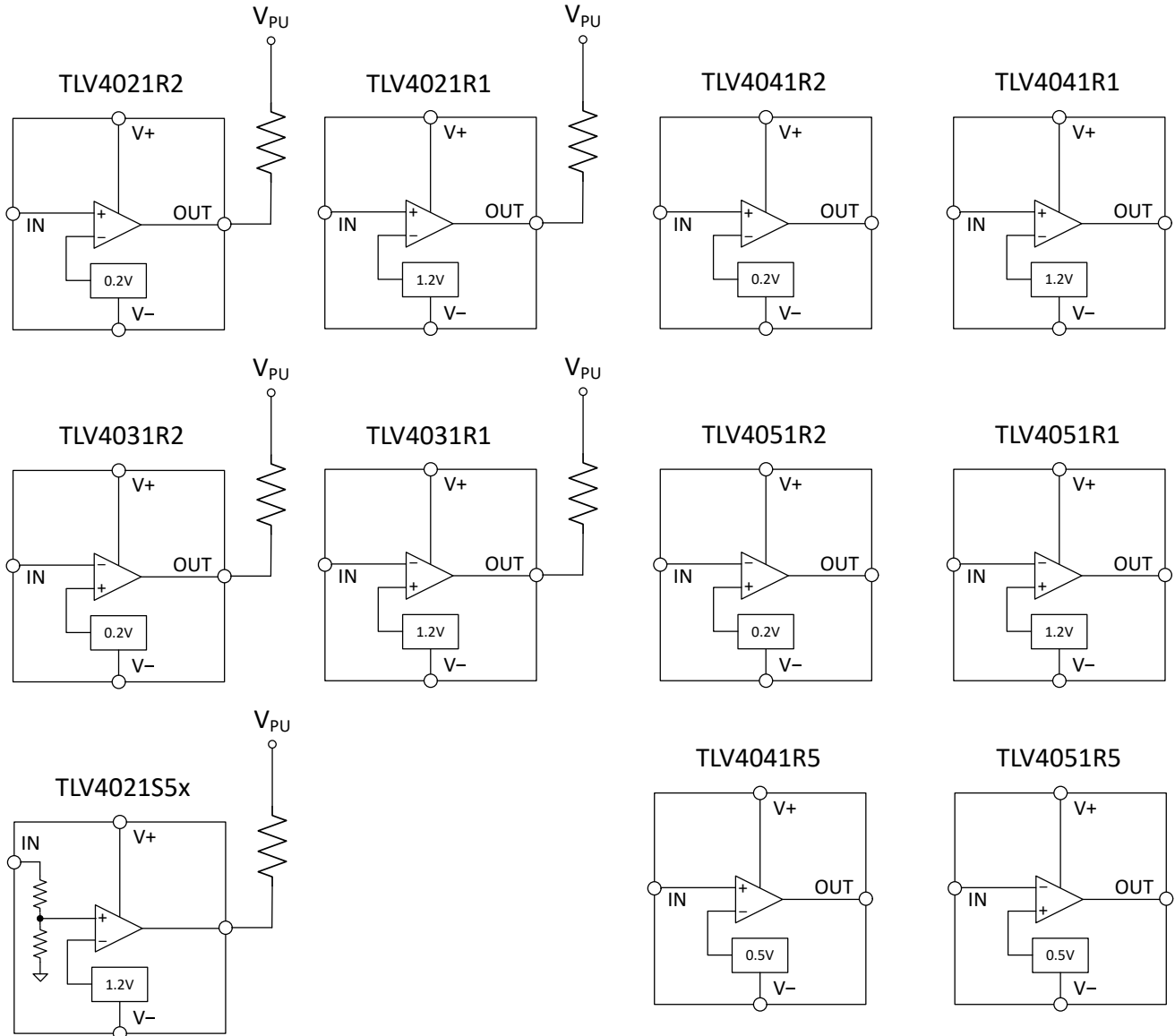
TLV40x1 Configurations



**Table 3-1. TLV40x1 Truth Table**

DEVICE	Input Configuration	Reference	Output Type
TLV4021R1	Non-Inverting	1.2 V	Open-Drain
TLV4041R1			Push-Pull
TLV4041R5		0.5 v	Push-Pull
TLV4021R2		0.2 V	Open-Drain
TLV4041R2	Push-Pull		
TLV4031R1	Inverting	1.2 V	Open-Drain
TLV4051R1			Push-Pull
TLV4051R5		0.5 V	Push-Pull
TLV4031R2		0.2 V	Open-Drain
TLV4051R2			Push-Pull

DEVICE	Input Configuration	Fixed Threshold	Output Type
TLV4021S5x	Non-Inverting	3.2 V	Open-Drain



## Table of Contents

<b>1 Features</b> .....	1	8.4 Device Functional Modes.....	16
<b>2 Applications</b> .....	1	<b>9 Application and Implementation</b> .....	19
<b>3 Description</b> .....	1	9.1 Application Information.....	19
<b>4 Revision History</b> .....	3	9.2 Typical Application.....	21
<b>5 Pin Configuration and Functions</b> .....	4	9.3 What to Do and What Not to Do.....	23
<b>6 Specifications</b> .....	5	<b>10 Power Supply Recommendations</b> .....	24
6.1 Absolute Maximum Ratings.....	5	<b>11 Layout</b> .....	24
6.2 ESD Ratings.....	5	11.1 Layout Guidelines.....	24
6.3 Recommended Operating Conditions.....	5	11.2 Layout Example.....	24
6.4 Thermal Information.....	5	<b>12 Device and Documentation Support</b> .....	25
6.5 Electrical Characteristics.....	6	12.1 Receiving Notification of Documentation Updates.....	25
6.6 Switching Characteristics.....	7	12.2 Support Resources.....	25
<b>7 Typical Characteristics</b> .....	8	12.3 Trademarks.....	25
<b>8 Detailed Description</b> .....	14	12.4 Electrostatic Discharge Caution.....	25
8.1 Overview.....	14	12.5 Glossary.....	25
8.2 Functional Block Diagram.....	15	<b>13 Mechanical, Packaging, and Orderable Information</b> .....	25
8.3 Feature Description.....	16		

## 4 Revision History

NOTE: Page numbers for previous revisions may differ from page numbers in the current version.

<b>Changes from Revision B (June 2020) to Revision C (December 2021)</b>	<b>Page</b>
• Updated the numbering format for tables, figures, and cross-references throughout the document .....	1
• Added TLV4021S5x throughout the document .....	1

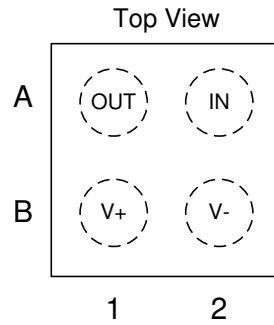
---

<b>Changes from Revision A (May 2019) to Revision B (March 2020)</b>	<b>Page</b>
• Added SOT-23 package option with 0.5V reference. ....	1
• Changed configuration diagram and TLV40x1 Truth Table. ....	1
• Added Configuration diagrams for entire TLV40x1 family.....	1

---

<b>Changes from Revision * (October 2018) to Revision A (May 2019)</b>	<b>Page</b>
• Changed Product Preview to Production Data .....	1

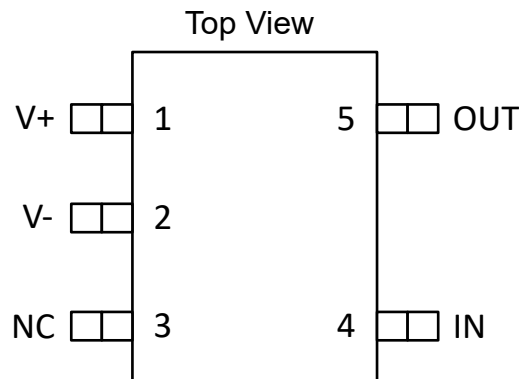
## 5 Pin Configuration and Functions



**Figure 5-1. YKA Package  
4-Bump DSBGA  
Top View**

**Table 5-1. DSBGA Package Pin Functions**

PIN		I/O	DESCRIPTION
NAME	NUMBER		
OUT	A1	O	Comparator output: OUT is push-pull on TLV4041/4051 and open-drain on TLV4021/4031
V+	B1	P	Positive (highest) power supply
V-	B2	P	Negative (lowest) power supply
IN	A2	I	Comparator input: IN is non-Inverting on TLV4021/4041 and inverting on TLV4031/4051



**Figure 5-2. SOT-23 Package  
5-pin  
Top View**

**Table 5-2. SOT-23 Pin Functions**

PIN		I/O	DESCRIPTION
NAME	NUMBER		
V+	1	P	Positive (highest) power supply
V-	2	P	Negative (lowest) power supply
NC	3	x	No connect; this pin is not internally connected to the die. It can be grounded if that is preferred in the system.
IN	4	I	Comparator input: IN is inverting on TLV4031/4051
OUT	5	O	Comparator output: OUT is push-pull on TLV4041/4051

## 6 Specifications

### 6.1 Absolute Maximum Ratings

over operating free-air temperature range (unless otherwise noted)<sup>(1)</sup>

		MIN	MAX	UNIT
Supply voltage: $V_S = (V+) - (V-)$		-0.3	6	V
Input voltage (IN) from $(V-)$ <sup>(2)</sup>		-0.3	6	V
Input Current (IN) <sup>(2)</sup>			±10	mA
Output voltage (OUT) from $(V-)$	TLV4021, TLV4031	-0.3	6	V
	TLV4041, TLV4051	-0.3	$(V+) + 0.3$	V
Output short-circuit duration <sup>(3)</sup>			10	s
Junction temperature, $T_J$			150	°C
Storage temperature, $T_{stg}$		-65	150	°C

- (1) Stresses beyond those listed under *Absolute Maximum Ratings* may cause permanent damage to the device. These are stress ratings only, which do not imply functional operation of the device at these or any other conditions beyond those indicated under *Recommended Operating Conditions*. Exposure to absolute-maximum-rated conditions for extended periods may affect device reliability.
- (2) Input terminals are diode-clamped to  $(V-)$ . Input signals that can swing more than 0.3 V below  $(V-)$  must be current-limited to 10 mA or less.  
In addition, IN can be greater than  $(V+)$  and OUT as long as it is within the -0.3 V to 6 V range. Input signals that can swing beyond this range must be current-limited to 10 mA or less.
- (3) Short-circuit to ground.

### 6.2 ESD Ratings

		VALUE	UNIT
$V_{(ESD)}$	Electrostatic discharge	Human-body model (HBM), per ANSI/ESDA/JEDEC JS-001 <sup>(1)</sup>	±2000
		Charged-device model (CDM), per JEDEC specification JESD22-C101 <sup>(2)</sup>	±1000

- (1) JEDEC document JEP155 states that 500-V HBM allows safe manufacturing with a standard ESD control process.
- (2) JEDEC document JEP157 states that 250-V CDM allows safe manufacturing with a standard ESD control process.

### 6.3 Recommended Operating Conditions

over operating free-air temperature range (unless otherwise noted)

		MIN	MAX	UNIT
Supply voltage: $V_S = (V+) - (V-)$		1.6	5.5	V
Ambient temperature, $T_A$		-40	125	°C

### 6.4 Thermal Information

THERMAL METRIC <sup>(1)</sup>		TLV40x1		UNIT
		YKA (DSBGA)	SOT-23 (DBV)	
		4 BUMPS	5 PINS	
$R_{\theta JA}$	Junction-to-ambient thermal resistance	205.5	181.7	°C/W
$R_{\theta JC(top)}$	Junction-to-case (top) thermal resistance	1.8	101.1	°C/W
$R_{\theta JB}$	Junction-to-board thermal resistance	75.3	52.0	°C/W
$\psi_{JT}$	Junction-to-top characterization parameter	0.9	28.2	°C/W
$\psi_{JB}$	Junction-to-board characterization parameter	74.7	51.6	°C/W
$R_{\theta JC(bot)}$	Junction-to-case (bottom) thermal resistance	N/A	N/A	°C/W

- (1) For more information about traditional and new thermal metrics, see the [Semiconductor and IC Package Thermal Metrics](#) application report.

## 6.5 Electrical Characteristics

 $V_S = 1.8\text{ V to }5\text{ V}$ , typical values are at  $T_A = 25^\circ\text{C}$ .

PARAMETER		TEST CONDITIONS	MIN	TYP	MAX	UNIT
$V_{IT+}$	Positive-going input threshold voltage	$V_S = 1.8\text{ V and }5\text{ V}, T_A = 25^\circ\text{C}$	1.194	1.2	1.206	V
	Positive-going input threshold voltage	$V_S = 1.8\text{ V and }5\text{ V}, T_A = -40^\circ\text{C to }+125^\circ\text{C}$	1.188		1.212	
$V_{IT-}$	Negative-going input threshold voltage	$V_S = 1.8\text{ V and }5\text{ V}, T_A = 25^\circ\text{C}$	1.174	1.18	1.186	
	Negative-going input threshold voltage	$V_S = 1.8\text{ V and }5\text{ V}, T_A = -40^\circ\text{C to }+125^\circ\text{C}$	1.168		1.192	
$V_{IT+}$	Positive-going input threshold voltage	$V_S = 1.8\text{ V and }5\text{ V}, T_A = 25^\circ\text{C}$	0.197	0.2	0.203	V
	Positive-going input threshold voltage	$V_S = 1.8\text{ V and }5\text{ V}, T_A = -40^\circ\text{C to }+125^\circ\text{C}$	0.196		0.204	
$V_{IT-}$	Negative-going input threshold voltage	$V_S = 1.8\text{ V and }5\text{ V}, T_A = 25^\circ\text{C}$	0.177	0.18	0.183	
	Negative-going input threshold voltage	$V_S = 1.8\text{ V and }5\text{ V}, T_A = -40^\circ\text{C to }+125^\circ\text{C}$	0.176		0.184	
$V_{IT+}$	Positive-going input threshold voltage (TLV40x1R5 only)	$V_S = 1.8\text{ V and }5\text{ V}, T_A = 25^\circ\text{C}$	0.495	0.5	0.505	V
	Positive-going input threshold voltage (TLV40x1R5 only)	$V_S = 1.8\text{ V and }5\text{ V}, T_A = -40^\circ\text{C to }+125^\circ\text{C}$	0.49		0.51	V
$V_{IT-}$	Negative-going input threshold voltage (TLV40x1R5 only)	$V_S = 1.8\text{ V and }5\text{ V}, T_A = 25^\circ\text{C}$	0.4752	0.48	0.4848	V
	Negative-going input threshold voltage (TLV40x1R5 only)	$V_S = 1.8\text{ V and }5\text{ V}, T_A = -40^\circ\text{C to }+125^\circ\text{C}$	0.4704		0.4896	V
$V_{IT+}$	Positive-going input threshold voltage	$V_S = 1.8\text{ V and }5\text{ V}, T_A = 25^\circ\text{C}$	3.238	3.254	3.270	V
	Positive-going input threshold voltage	$V_S = 1.8\text{ V and }5\text{ V}, T_A = -40^\circ\text{C to }+125^\circ\text{C}$	3.221		3.287	V
$V_{IT-}$	Negative-going input threshold voltage	$V_S = 1.8\text{ V and }5\text{ V}, T_A = 25^\circ\text{C}$	3.184	3.2	3.216	V
	Negative-going input threshold voltage	$V_S = 1.8\text{ V and }5\text{ V}, T_A = -40^\circ\text{C to }+125^\circ\text{C}$	3.168		3.232	V
$V_{HYS}^{(2)}$	Input hysteresis voltage	$V_S = 1.8\text{ V and }5\text{ V}, T_A = 25^\circ\text{C}$		20		mV
$V_{HYS}$	Input hysteresis voltage (TLV40x1R5 only)	$V_S = 1.8\text{ V and }5\text{ V}, T_A = 25^\circ\text{C}$		20		mV
$V_{HYS}^{(2)}$	Input hysteresis voltage	$V_S = 1.8\text{ V and }5\text{ V}, T_A = 25^\circ\text{C}$		54		mV
$V_{IN}$	Input voltage range	$T_A = -40^\circ\text{C to }+125^\circ\text{C}$	V–		5.5	V
$I_{BIAS}$	Input bias current	Over $V_{IN}$ range		10		pA
$I_{BIAS}$	Input bias current (TLV4021S5x only)	$I_N = 3.3\text{ V}$		1.65		$\mu\text{A}$
$V_{OL}$	Voltage output swing from (V–)	$I_{SINK} = 200\text{ }\mu\text{A}$ , OUT asserted low, $V_S = 5\text{ V}, T_A = -40^\circ\text{C to }+125^\circ\text{C}$			100	mV
		$I_{SINK} = 3\text{ mA}$ , OUT asserted low, $V_S = 5\text{ V}, T_A = -40^\circ\text{C to }+125^\circ\text{C}$			400	mV
$V_{OH}$	Voltage output swing from (V+) (TLV4041/4051 only)	$I_{SOURCE} = 200\text{ }\mu\text{A}$ , OUT asserted high, $V_S = 5\text{ V}, T_A = -40^\circ\text{C to }+125^\circ\text{C}$			100	mV
		$I_{SOURCE} = 3\text{ mA}$ , OUT asserted high, $V_S = 5\text{ V}, T_A = -40^\circ\text{C to }+125^\circ\text{C}$			400	mV
$I_{O-LKG}$	Open-drain output leakage current (TLV4021/4031 only)	$V_S = 5\text{ V}$ , OUT asserted high $V_{PULLUP} = (V+)$ , $T_A = 25^\circ\text{C}$		20		pA
$I_{SC}$	Short-circuit current	$V_S = 5\text{ V}$ , sinking, $T_A = 25^\circ\text{C}$		55		mA
$I_{SC}$	Short-circuit current	$V_S = 5\text{ V}$ , sourcing, $T_A = 25^\circ\text{C}$ (TLV4041/4051 only)		50		mA

## 6.5 Electrical Characteristics (continued)

$V_S = 1.8\text{ V}$  to  $5\text{ V}$ , typical values are at  $T_A = 25^\circ\text{C}$ .

PARAMETER		TEST CONDITIONS	MIN	TYP	MAX	UNIT
$I_Q$	Quiescent current	No load, $T_A = 25^\circ\text{C}$ , Output Low, $V_S = 1.8\text{ V}$		2	3.5	$\mu\text{A}$
		No load, $T_A = -40^\circ\text{C}$ to $+125^\circ\text{C}$ , Output Low, $V_S = 1.8\text{ V}$			5	$\mu\text{A}$
$V_{POR}^{(1)}$	Power-on reset voltage			1.45		V

- (1) See Section 7.4.1 (Power ON Reset) for more details.  
 (2) See Section 7.4.3 (Switching Thresholds and Hysteresis) for more details.

## 6.6 Switching Characteristics

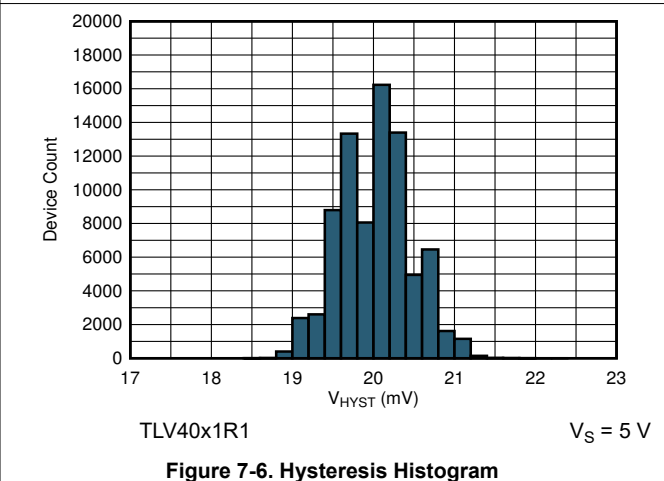
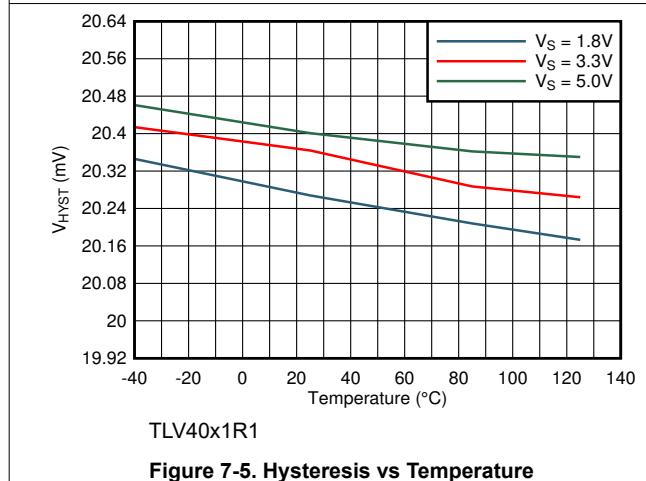
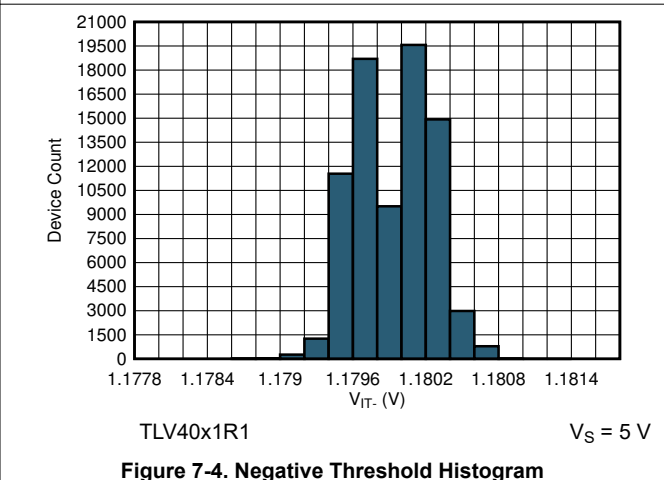
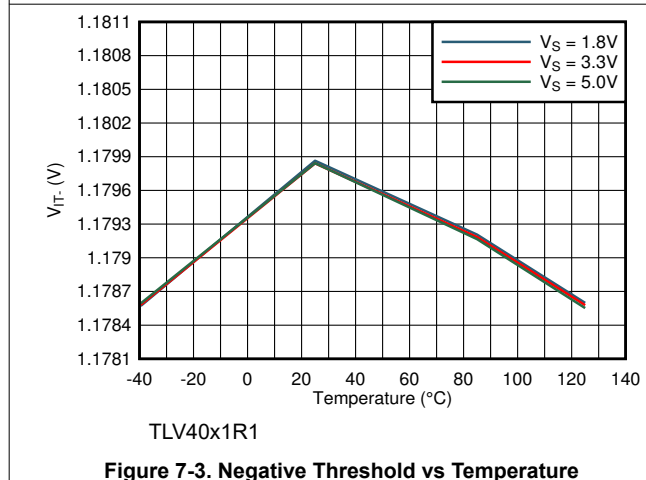
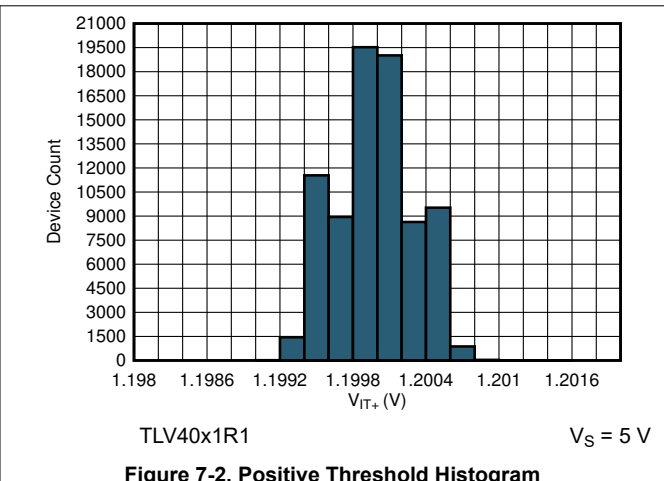
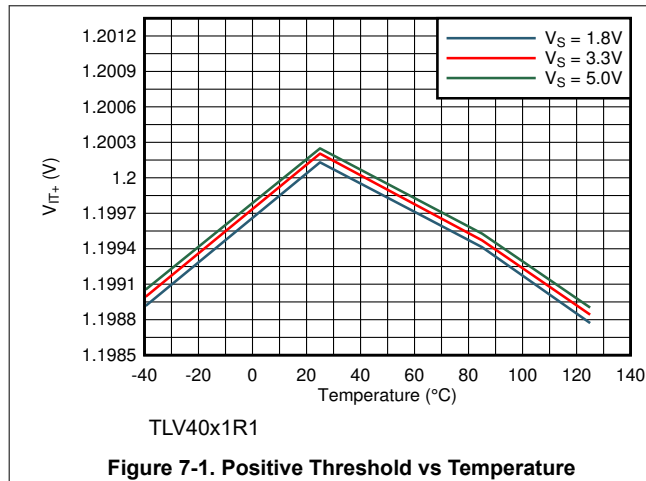
Typical values are at  $T_A = 25^\circ\text{C}$ ,  $V_S = 3.3\text{ V}$ ,  $C_L = 15\text{ pF}$ ; Input overdrive =  $100\text{ mV}$  for TLV40x1Ry & 5% for TLV4021S5x,  $R_P = 4.99\text{ k}\Omega$  for open-drain options (unless otherwise noted).

PARAMETER		TEST CONDITIONS	MIN	TYP	MAX	UNIT
$t_{PHL}$	Propagation delay, high-to-low <sup>(1)</sup>	Midpoint of input to midpoint of output		360		ns
$t_{PLH}$	Propagation delay, low-to-high <sup>(1)</sup>	Midpoint of input to midpoint of output		360		ns
$t_{PHL}$	Propagation delay, high-to-low <sup>(1)</sup> (TLV4021S5x only)	Midpoint of input to midpoint of output		2		$\mu\text{s}$
$t_{PLH}$	Propagation delay, low-to-high <sup>(1)</sup> (TLV4021S5x only)	Midpoint of input to midpoint of output		2		$\mu\text{s}$
$t_R$	Rise time (TLV4041/4051 only)	20% to 80%		10		ns
$t_F$	Fall time	20% to 80%		10		ns
$t_{ON}$	Power-up time <sup>(2)</sup>			500		$\mu\text{s}$

- (1) High-to-low and low-to-high refers to the transition at the input.  
 (2) During power on cycle,  $V_S$  must exceed  $1.6\text{ V}$  for  $t_{ON}$  before the output will reflect the condition on the input. Prior to  $t_{ON}$  elapsing, the output is controlled by the POR circuit.

## 7 Typical Characteristics

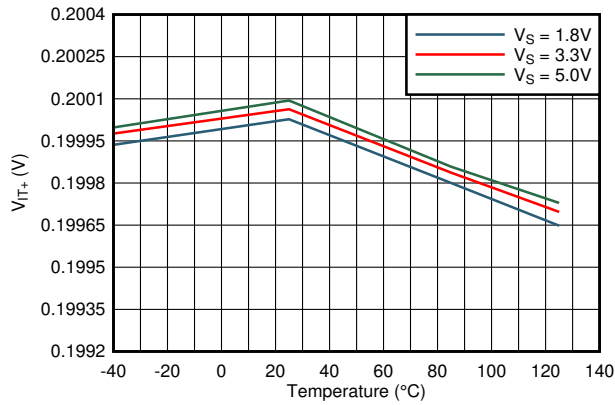
at  $T_J = 25^\circ\text{C}$  and  $V_S = 3.3\text{ V}$  (unless otherwise noted)





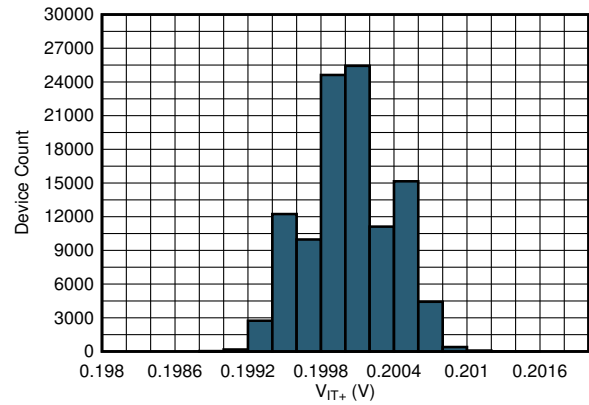
## 7 Typical Characteristics (continued)

at  $T_J = 25^\circ\text{C}$  and  $V_S = 3.3\text{ V}$  (unless otherwise noted)



TLV40x1R2

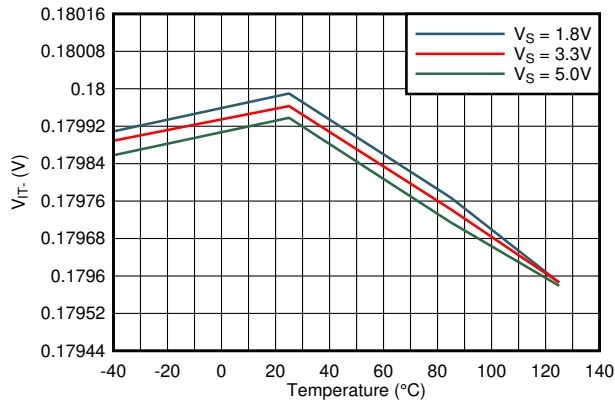
**Figure 7-7. Positive Threshold vs Temperature**



TLV40x1R2

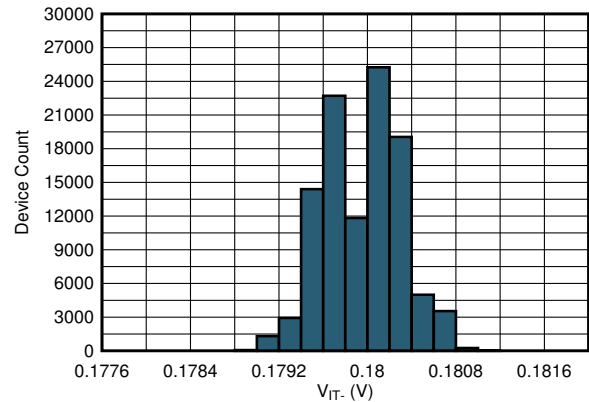
$V_S = 5\text{ V}$

**Figure 7-8. Positive Threshold Histogram**



TLV40x1R2

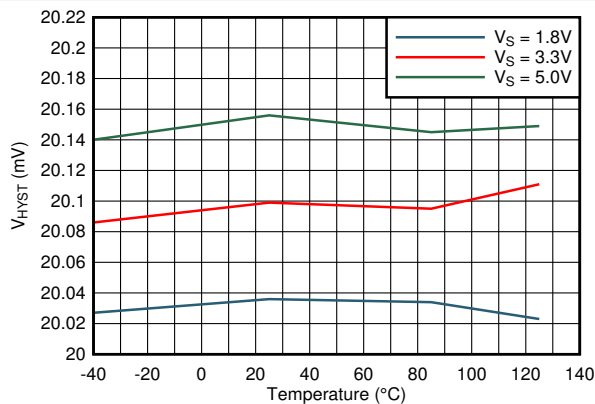
**Figure 7-9. Negative Threshold vs Temperature**



TLV40x1R2

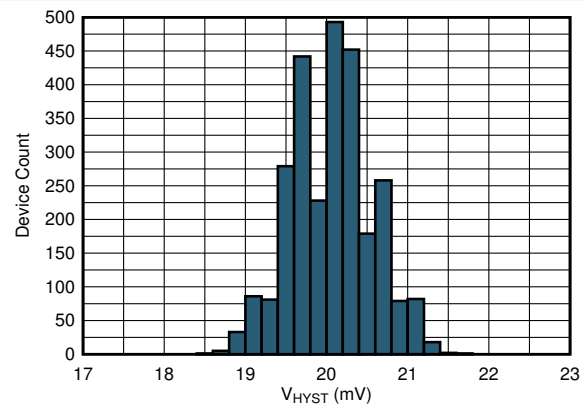
$V_S = 5\text{ V}$

**Figure 7-10. Negative Threshold Histogram**



TLV40x1R2

**Figure 7-11. Hysteresis vs Temperature**



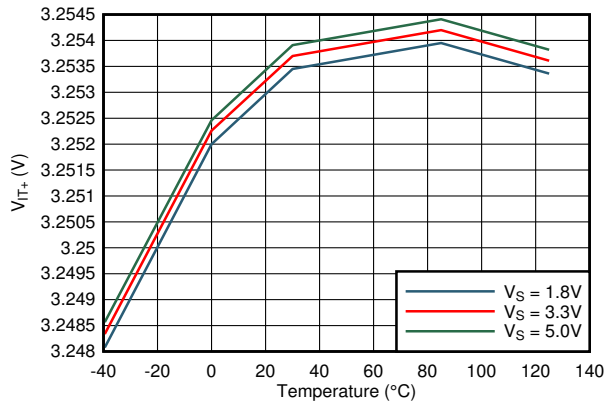
TLV40x1R2

$V_S = 5\text{ V}$

**Figure 7-12. Hysteresis Histogram**

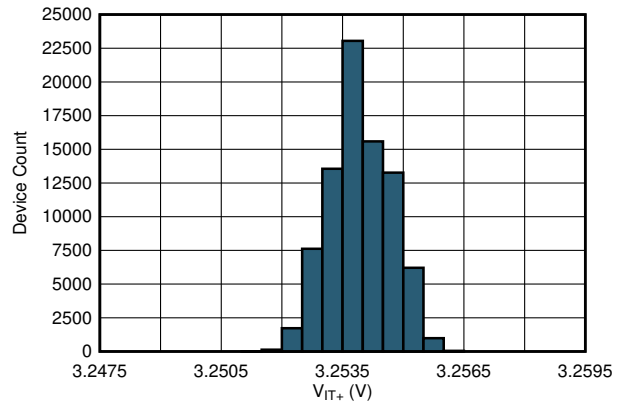
## 7 Typical Characteristics (continued)

at  $T_J = 25^\circ\text{C}$  and  $V_S = 3.3\text{ V}$  (unless otherwise noted)



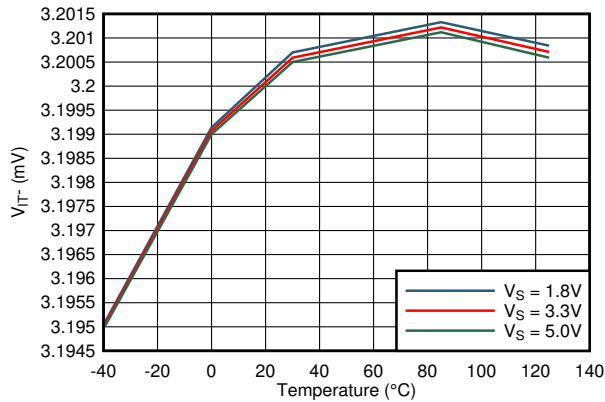
TLV4021S5x

**Figure 7-13. Positive Threshold vs Temperature**



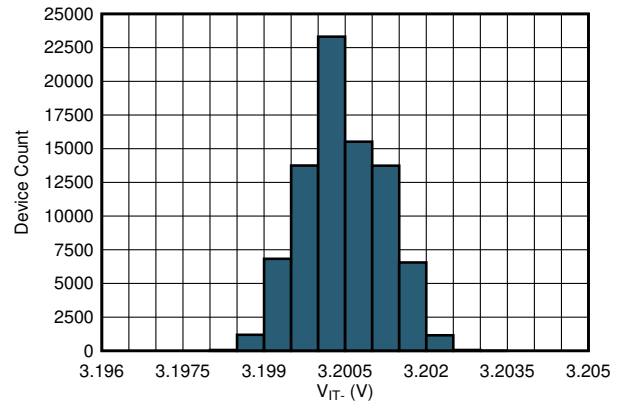
TLV4021S5x

**Figure 7-14. Positive Threshold Histogram**



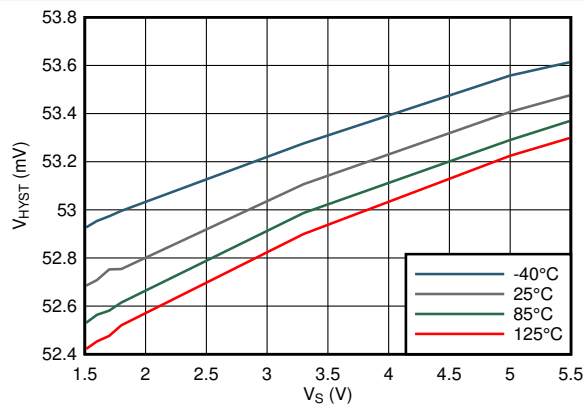
TLV4021S5x

**Figure 7-15. Negative Threshold vs Temperature**



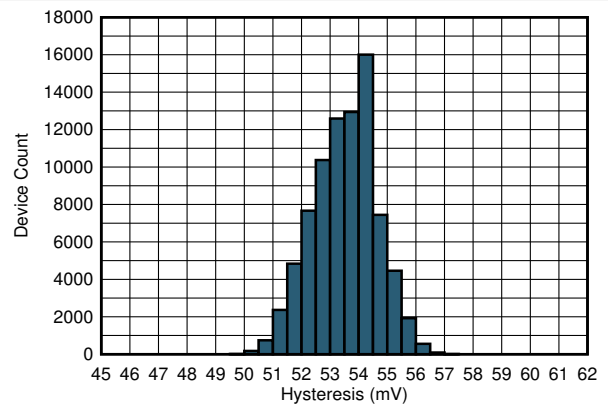
TLV4021S5x

**Figure 7-16. Negative Threshold Histogram**



TLV4021S5x

**Figure 7-17. Hysteresis vs Supply Voltage**

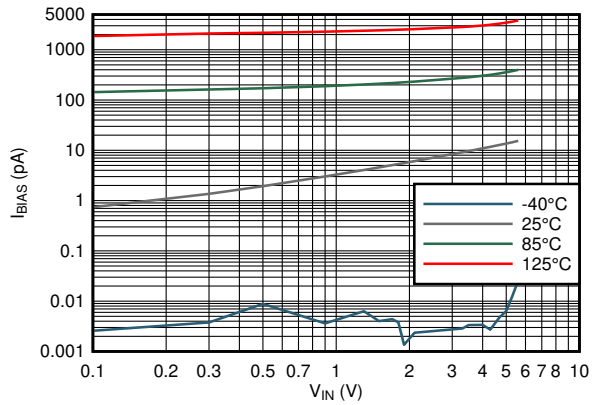


TLV4021S5x

**Figure 7-18. Hysteresis Histogram**

## 7 Typical Characteristics (continued)

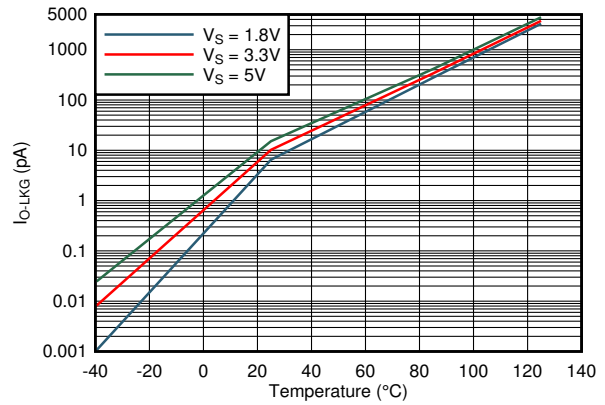
at  $T_J = 25^\circ\text{C}$  and  $V_S = 3.3\text{ V}$  (unless otherwise noted)



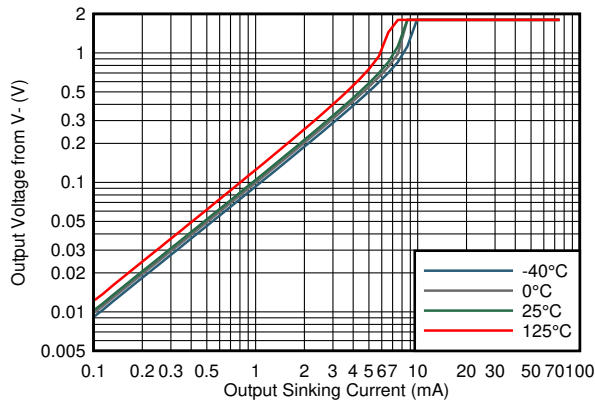
$V_S = 1.8\text{ V to }5\text{ V}$

TLV40x1Ry

**Figure 7-19. Bias Current vs Common Mode Voltage**

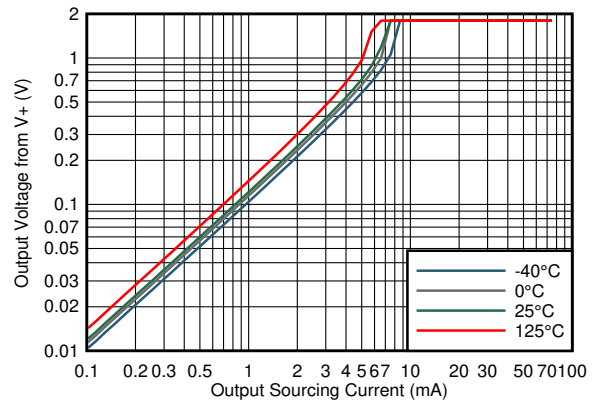


**Figure 7-20. Output Current Leakage vs Temperature**



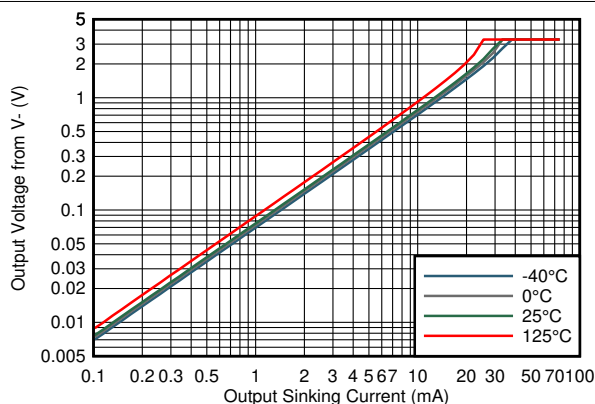
$V_S = 1.8\text{ V}$

**Figure 7-21. Output Voltage vs Output Sinking Current**



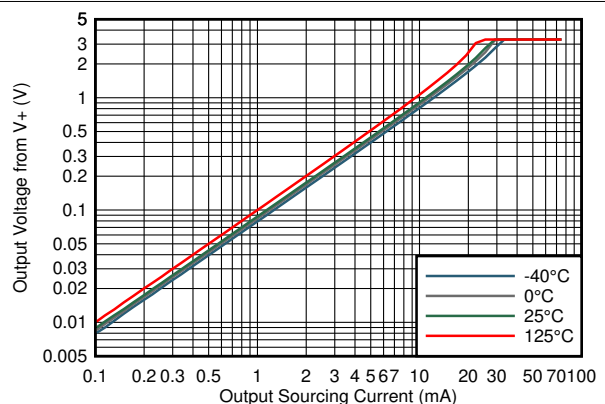
$V_S = 1.8\text{ V}$

**Figure 7-22. Output Voltage vs Output Sourcing Current**



$V_S = 3.3\text{ V}$

**Figure 7-23. Output Voltage vs Output Sinking Current**

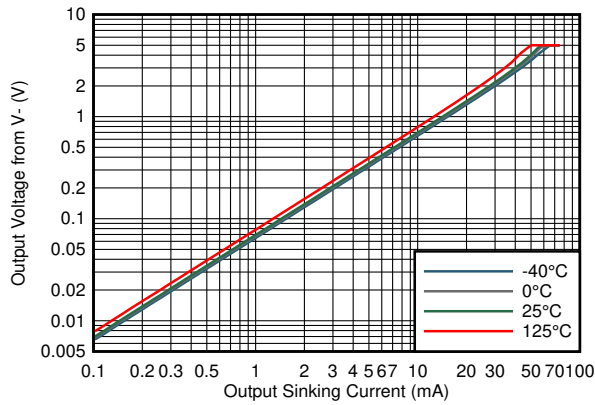


$V_S = 3.3\text{ V}$

**Figure 7-24. Output Voltage vs Output Sourcing Current**

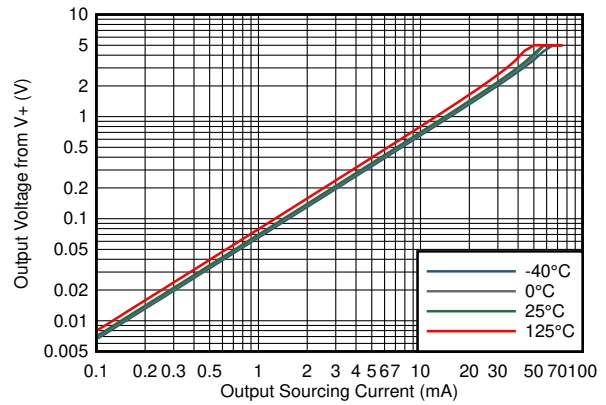
## 7 Typical Characteristics (continued)

at  $T_J = 25^\circ\text{C}$  and  $V_S = 3.3\text{ V}$  (unless otherwise noted)



$V_S = 5\text{V}$

Figure 7-25. Output Voltage vs Output Sinking Current



$V_S = 5\text{V}$

Figure 7-26. Output Voltage vs Output Sourcing Current

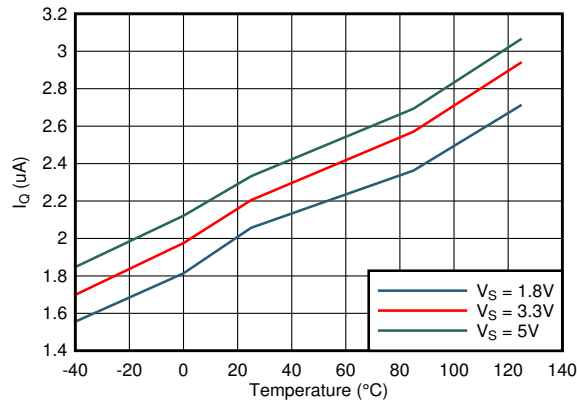
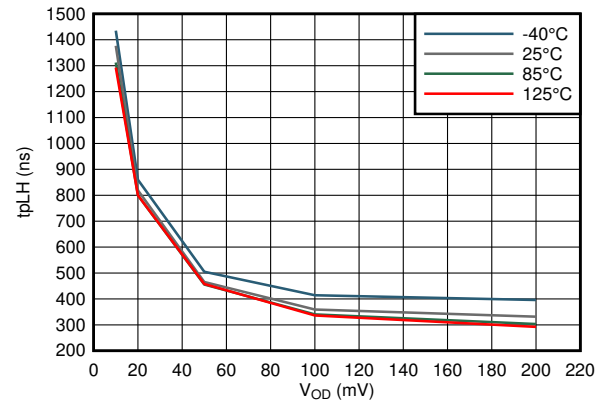


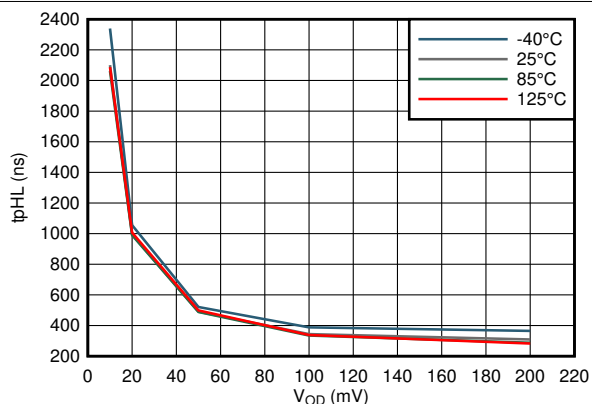
Figure 7-27. Supply Current vs Temperature



$V_S = 1.8\text{V to } 5\text{V}$

TLV40x1R2

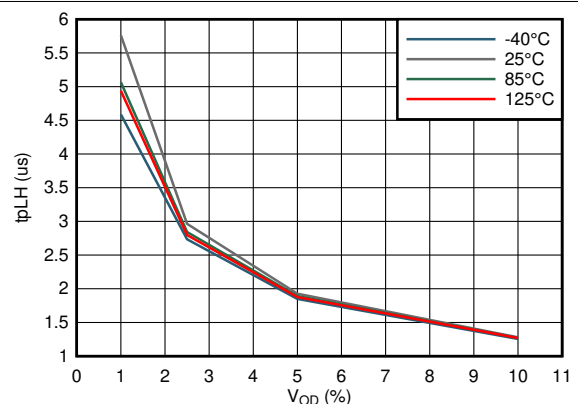
Figure 7-28. Propagation Delay Low-High vs Input Overdrive



$V_S = 1.8\text{V to } 5\text{V}$

TLV40x1R2

Figure 7-29. Propagation Delay High-Low vs Input Overdrive



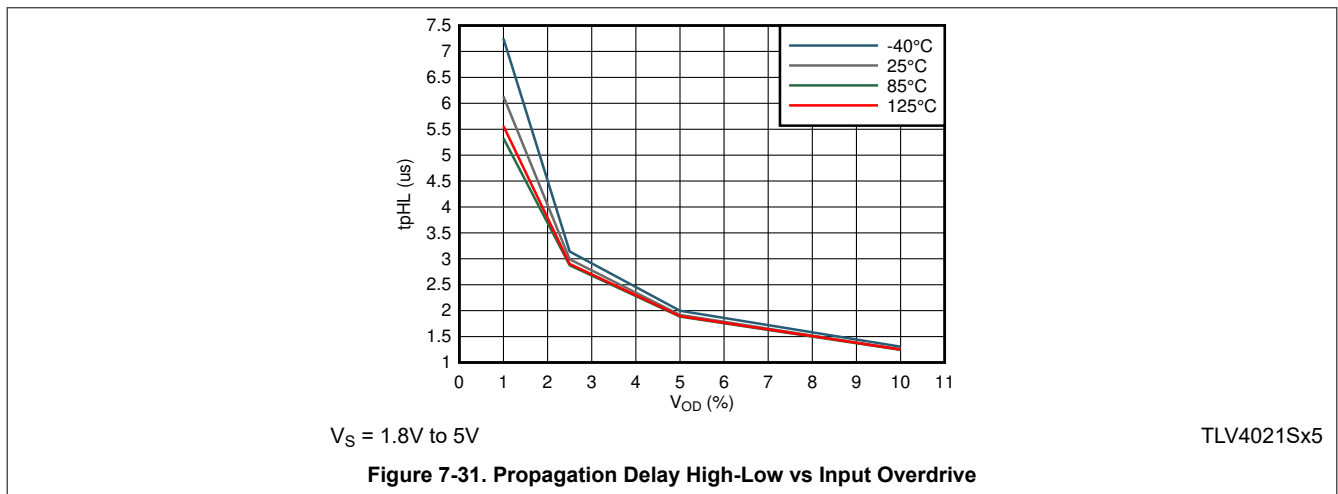
$V_S = 1.8\text{V to } 5\text{V}$

TLV4021Sx5

Figure 7-30. Propagation Delay Low-High vs Input Overdrive

## 7 Typical Characteristics (continued)

at  $T_J = 25^\circ\text{C}$  and  $V_S = 3.3\text{ V}$  (unless otherwise noted)



## 8 Detailed Description

### 8.1 Overview

The TLV40x1 devices are low-power comparators that are well suited for compact, low-current, precision voltage detection applications. With high-accuracy, switching thresholds options of 0.2V, 0.5 V, 1.2V, and 3.2V, 2uA of quiescent current, and propagation delay of 450ns and 2us, the TLV40x1 comparator family enables power conscious systems to monitor and respond quickly to fault conditions.

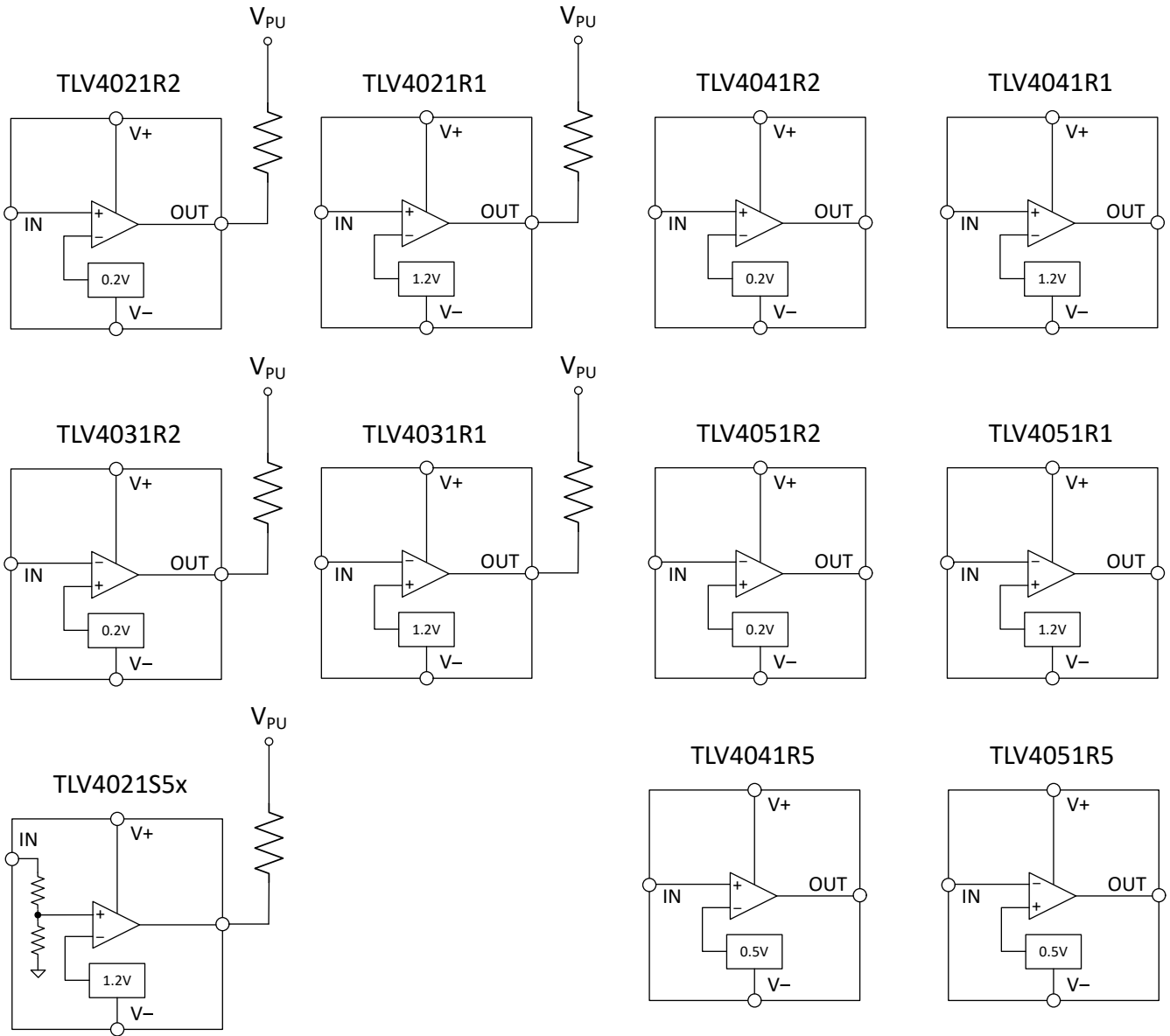
The TLV40x1Ry comparators assert the output signal as shown in [Table 8-1](#).  $V_{IT+}$  represents the positive-going input threshold that causes the comparator output to change state, while  $V_{IT-}$  represents the negative-going input threshold that causes the output to change state. Since  $V_{IT+}$  and  $V_{IT-}$  are factory trimmed and warranted over temperature, the TLV40x1 is equally suited for undervoltage and overvoltage applications. In order to monitor any voltage above the internal reference voltage, an external resistor divider network is required.

The TLV4021S5x functions similar to the TLV40x1Ry comparators except the resistor divider is internal to the device. Having the resistor divider internal to the device allows the TLV4021S5x to have switching thresholds higher than the internal reference voltage of 1.2V without any external components.

**Table 8-1. TLV40x1 Truth Table**

DEVICE	( $V_{IT+}$ , $V_{IT-}$ )	OUTPUT TOPOLOGY	INPUT VOLTAGE	OUTPUT LOGIC LEVEL
TLV4021R2 TLV4021R1	0.2V, 0.18V 1.2V, 1.18V	Open-Drain	$IN > V_{IT+}$	Output high impedance
			$IN < V_{IT-}$	Output asserted low
TLV4041R2 TLV4041R5 TLV4041R1	0.2V, 0.18V 0.5V, 0.48V 1.2V, 1.18V	Push-Pull	$IN > V_{IT+}$	Output asserted high
			$IN < V_{IT-}$	Output asserted low
TLV4031R2 TLV4031R1	0.2V, 0.18V 1.2V, 1.18V	Open-Drain	$IN > V_{IT+}$	Output asserted low
			$IN < V_{IT-}$	Output high impedance
TLV4051R2 TLV4051R5 TLV4051R1	0.2V, 0.18V 0.5V, 0.48V 1.2V, 1.18V	Push-Pull	$IN > V_{IT+}$	Output asserted low
			$IN < V_{IT-}$	Output asserted high
TLV4021S5x	3.254V, 3.2V	Open-Drain	$IN > V_{IT+}$	Output high impedance
			$IN < V_{IT-}$	Output asserted low

## 8.2 Functional Block Diagram



## 8.3 Feature Description

The TLV40x1 is a family of 4-pin, precision, low-power comparators with precision switching thresholds. The TLV40x1 comparators feature a rail-to-rail input stage with factory programmed switching thresholds for both rising and falling input waveforms. The comparator family also supports open-drain and push-pull output configurations as well as non-inverting and inverting inputs.

## 8.4 Device Functional Modes

### 8.4.1 Power ON Reset (POR)

The TLV40x1 comparators have a Power-on-Reset (POR) circuit which provides system designers a known start-up condition for the output of the comparators. When the power supply ( $V_S$ ) is ramping up or ramping down, the POR circuit will be active when  $V_S$  is below  $V_{POR}$ . For the TLV4021 and TLV4031, the POR circuit will force the output to High-Z, and for the TLV4041 and TLV4051, the POR circuit will hold the output low at ( $V_-$ ). When  $V_S$  is greater than, or equal to, the minimum recommended operating voltage, the comparator output reflects the state of the input (IN).

The following pictures represent how the TLV40x1 outputs respond for  $V_S$  rising and falling. For the comparators with open-drain outputs (TLV4021/4031), IN is connected to ( $V_-$ ) to highlight the transition from POR circuit control to standard comparator operation where the output reflects the input condition. Note how the output goes low when  $V_S$  reaches 1.45V. Likewise, for the comparators with push-pull outputs (TLV4041/4051), the input is connected to ( $V_+$ ). Note how the output goes high when  $V_S$  reaches 1.45V.

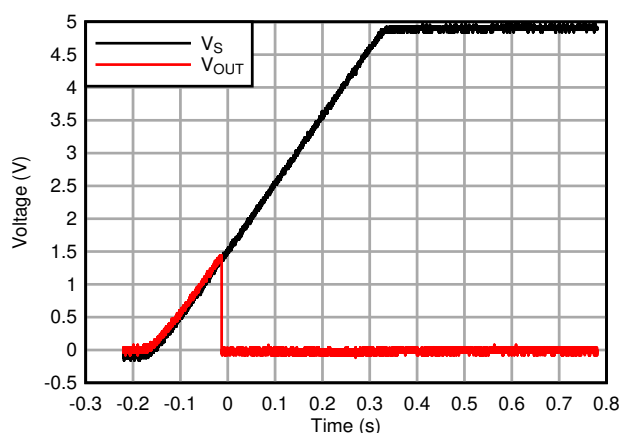


Figure 8-1. TLV4021/4031 Output for  $V_S$  Rising

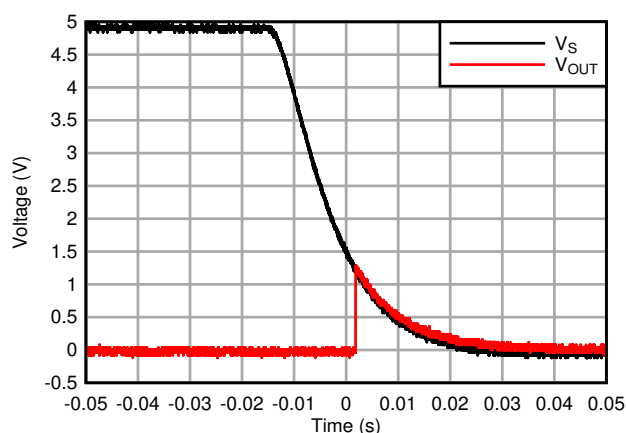


Figure 8-2. TLV4021/4031 Output for  $V_S$  Falling

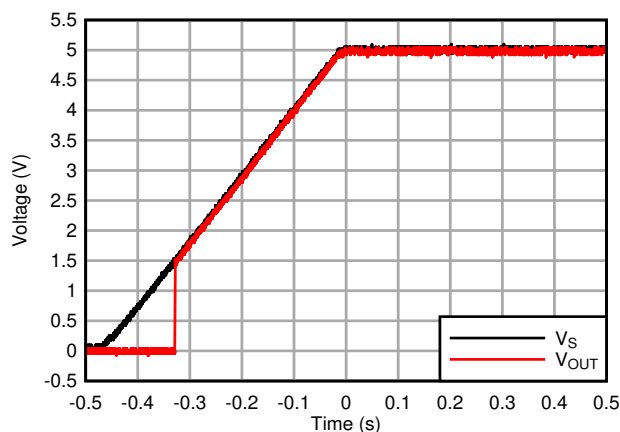


Figure 8-3. TLV4041/4051 Output for  $V_S$  Rising

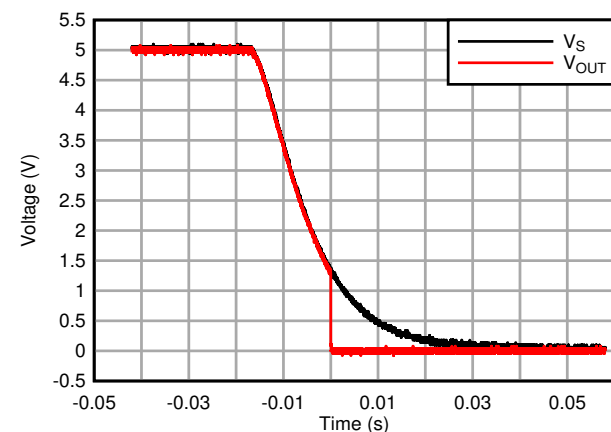


Figure 8-4. TLV4041/4051 Output for  $V_S$  Falling



### 8.4.2 Input (IN)

The TLV40x1 comparators have two inputs: one external input (IN) and one internal input that is connected to the integrated voltage reference. The comparator rising threshold is trimmed to the reference voltage ( $V_{IT+}$ ) while the falling threshold is trimmed to ( $V_{IT-}$ ). Since the rising and falling thresholds are both trimmed and warranted in the Electrical Characteristics Table, the TLV40x1 is equally suited for undervoltage and overvoltage detection. The difference between ( $V_{IT+}$ ) and ( $V_{IT-}$ ) is referred to as the comparator hysteresis and is 20 mV for TLV40x1Ry and 54 mV for TLV4021S5x. The integrated hysteresis makes the TLV40x1 less sensitive to supply-rail noise and provides stable operation in noisy environments without having to add external positive feedback to create hysteresis.

The comparator input (IN) is able to swing 5.5 V above ( $V_-$ ) regardless of the device supply voltage. This includes the instance when no supply voltage is applied to the comparator ( $V_S = 0$  V). As a result, the TLV40x1 is referred to as fault tolerant, meaning it maintains the same high input impedance when  $V_S$  is unpowered or ramping up. While not required in most cases, in order to reduce sensitivity to transients and layout parasitics for extremely noisy applications, place a 1 nF to 100 nF bypass capacitor at the comparator input.

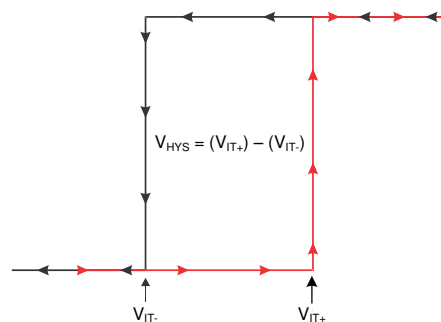
For the TLV40x1Ry comparators, the input bias current is typically 10 pA for input voltages between ( $V_-$ ) and ( $V_+$ ) and the value typically doubles for every 10°C temperature increase. The comparator input is protected from voltages below ( $V_-$ ) by an internal diode connected to ( $V_-$ ). As the input voltage goes below ( $V_-$ ), the protection diode becomes forward biased and begins to conduct causing the input bias current to increase exponentially. A series resistor is recommended to limit the input current when sources have signal content that is less than ( $V_-$ ).

For the TLV4021S5x, the input bias current is limited by the internal resistor divider with typical impedance of 2M ohms.

### 8.4.3 Switching Thresholds and Hysteresis ( $V_{HYS}$ )

The TLV40x1 transfer curve is shown in [Figure 8-5](#).

- $V_{IT+}$  represents the positive-going input threshold that causes the comparator output to change from a logic low state to a logic high state.
- $V_{IT-}$  represents the negative-going input threshold that causes the comparator output to change from a logic high state to a logic low state.
- $V_{HYS}$  represents the difference between  $V_{IT+}$  and  $V_{IT-}$  and is 20 mV for TLV40x1Ry and 54 mV for TLV4021S5x.



**Figure 8-5. Transfer Curve**

$V_{IT+}$  and  $V_{IT-}$  have mV's of variation over temperature. The significant portion of the variation of these parameters is a result of the internal bandgap voltage from which  $V_{IT+}$  and  $V_{IT-}$  are derived. The following hysteresis histograms demonstrate the performance of the TLV40x1 hysteresis circuitry. Since the bandgap reference is used to set  $V_{IT+}$  and  $V_{IT-}$ , each of these parameters have a tendency to error (track) in the same direction. For example, if  $V_{IT+}$  has a positive 0.5% error,  $V_{IT-}$  would have a tendency to have a similar positive percentage error. As a result, the variation of hysteresis will never be equal to the difference of the highest  $V_{IT+}$  value of its range and the lowest  $V_{IT-}$  value of its range.

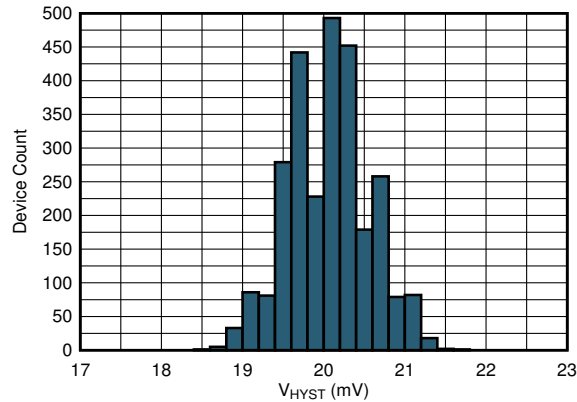


Figure 8-6. V<sub>HYST</sub> Histogram (TLV40x1R2, V<sub>S</sub>=5V)

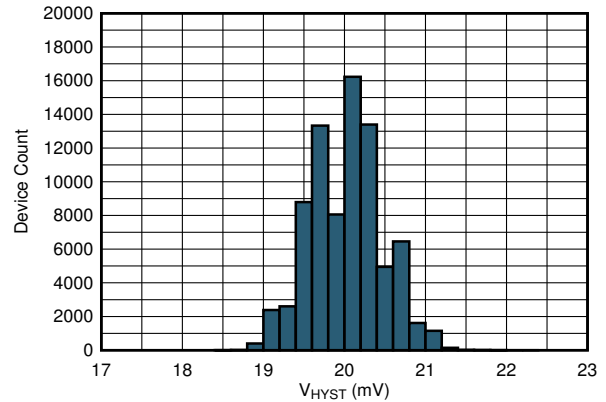


Figure 8-7. V<sub>HYST</sub> Histogram (TLV40x1R1, V<sub>S</sub>=5V)

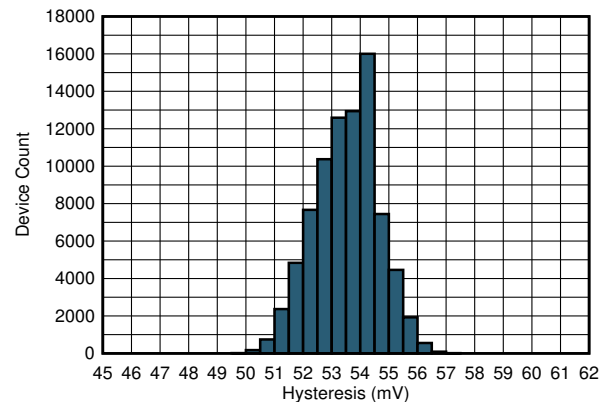


Figure 8-8. V<sub>HYST</sub> Histogram (TLV40x1S5, V<sub>S</sub>=5V)

#### 8.4.4 Output (OUT)

The TLV4041 and TLV4051 feature a push-pull output stage which eliminates the need for an external pull-up resistor while providing a low impedance output driver. Likewise, the TLV4021 and TLV4031 feature an open-drain output stage which enables the output logic levels to be pulled-up to an external source as high as 5.5 V independent of the supply voltage.

In a typical TLV40x1 application, OUT is connected to an enable input of a processor or a voltage regulator such as a dc-dc converter or low-dropout regulator (LDO). The open-drain output versions (TLV4021/4031) are used if the power supply of the comparator is different than the supply voltage of the device being controlled. In this usage case, a pull-up resistor holds OUT high when the comparator output goes high impedance. The correct interface-voltage level is provided (also known as level-shifting) by connecting the pull-up resistor on OUT to the appropriate voltage rail. The TLV4021/4031 output can be pulled up to 5.5 V, independent of the device supply voltage (V<sub>S</sub>). However, if level-shifting is not required, the push-pull output versions (TLV4041/4051) should be utilized in order to eliminate the need for the pull-up resistor.

## 9 Application and Implementation

### Note

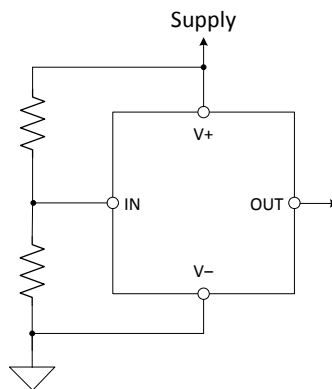
Information in the following applications sections is not part of the TI component specification, and TI does not warrant its accuracy or completeness. TI's customers are responsible for determining suitability of components for their purposes, as well as validating and testing their design implementation to confirm system functionality.

### 9.1 Application Information

The TLV40x1 is a 4-pin, low-power comparator with a precision, integrated reference. The comparators in this family are well suited for monitoring voltages and currents in portable, battery powered devices.

#### 9.1.1 Monitoring (V+)

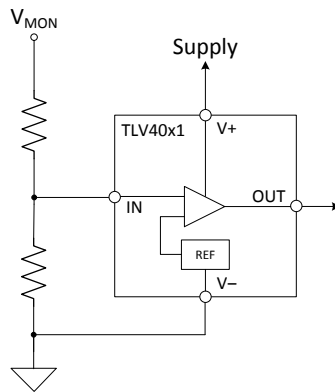
Many applications monitor the same rail that is powering the comparator. In these applications the resistor divider is simply connected to the (V+) rail.



**Figure 9-1. Supply Monitoring**

### 9.1.2 Monitoring a Voltage Other than (V+)

Some applications monitor rails other than the one that is powering the comparator. In these applications the resistor divider used to set the desired threshold is connected to the rail that is being monitored.

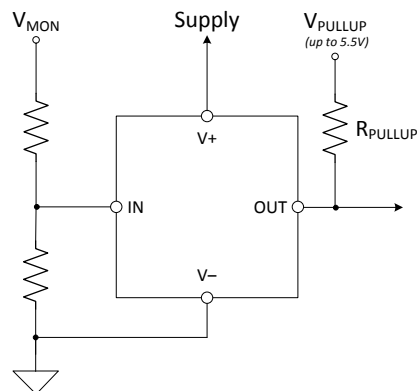


**Figure 9-2. Monitoring a Voltage Other than the Supply**

The TLV40x1Ry can monitor a voltage greater than the maximum (V+) with the use of an external resistor divider network. Likewise, the TLV40x1 can monitor voltages as low as the internal reference voltage (0.2 V, 0.5 V, or 1.2 V). The TLV40x1Ry also has the advantage of being able to monitor high impedance sources since the input bias current of the input (IN) is low. This provides an advantage over voltage supervisors that can only monitor the voltage rail that is powering them. Supervisors configured in this fashion have limitations in source impedance and minimum sensing voltage.

### 9.1.3 V<sub>PULLUP</sub> to a Voltage Other than (V+)

For applications where the output of the comparator needs to interface with a reset/enable pin that operates from a different supply voltage, the open-drain comparators (TLV4021/4031) should be selected. In these usage cases, the output can be pulled up to any voltage that is lower than 5.5V (independent of (V+)). This technique is commonly referred to as "level-shifting."

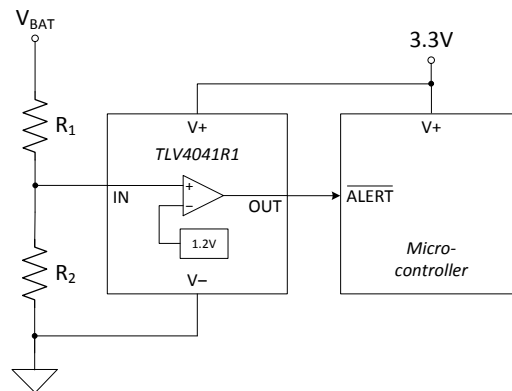


**Figure 9-3. Level-Shifting**

## 9.2 Typical Application

### 9.2.1 Under-Voltage Detection

Under-voltage detection is frequently required in battery-powered, portable electronics to alert the system that a battery voltage has dropped below the usable voltage level. Figure 9-4 shows a simple under-voltage detection circuit using the TLV4041R1 which is a non-inverting comparator with an integrated 1.2 V reference and a push-pull output stage. The non-inverting TLV4041 option was selected in this example since the micro-controller required an active low signal when an undervoltage level occurs. However, if an active high signal was required, the TLV4051 option with an inverting input stage would be utilized.



**Figure 9-4. Under-Voltage Detection**

#### 9.2.1.1 Design Requirements

For this design, follow these design requirements:

- Operate from 3.3 V power supply that powers the microcontroller.
- Under-voltage alert is active low.
- Logic low output when  $V_{BAT}$  is less than 2.0V.

#### 9.2.1.2 Detailed Design Procedure

Configure the circuit as shown in Figure 9-4. Connect (V+) to 3.3 V which also powers the micro-controller. Resistors  $R_1$  and  $R_2$  create the under-voltage alert level of 2.0 V. When the battery voltage sags down to 2.0 V, the resistor divider voltage crosses the ( $V_{IT-}$ ) threshold of the TLV4041R1. This causes the comparator output to transition from a logic high to a logic low. The push-pull option of the TLV40x1 family is selected since the comparator operating voltage is shared with the microcontroller which is receiving the under-voltage alert signal. The TLV4041 option with the 1.2 V internal reference is selected because it is the closest internal reference option that is less than the critical under-voltage level of 2.0 V. Choosing the internal reference option that is closest to the critical under-voltage level minimizes the resistor divider ratio which optimizes the accuracy of the circuit. Error at the falling edge threshold of ( $V_{IT-}$ ) is amplified by the inverse of the resistor divider ratio. So minimizing the resistor divider ratio is a way of optimizing voltage monitoring accuracy.

Equation 1 is derived from the analysis of Figure 9-4.

$$V_{IT-} = \frac{R_2}{R_1 + R_2} \times V_{BAT} \quad (1)$$

where

- $R_1$  and  $R_2$  are the resistor values for the resistor divider connected to IN
- $V_{BAT}$  is the voltage source that is being monitored for an undervoltage condition.
- $V_{IT-}$  is the falling edge threshold where the comparator output changes state from high to low

Rearranging Equation 1 and solving for  $R_1$  yields Equation 2.

$$R_1 = \frac{(V_{BAT} - V_{IT-})}{V_{IT-}} \times R_2 \quad (2)$$

For the specific undervoltage detection of 2.0 V using the TLV4041R1, the following results are calculated.

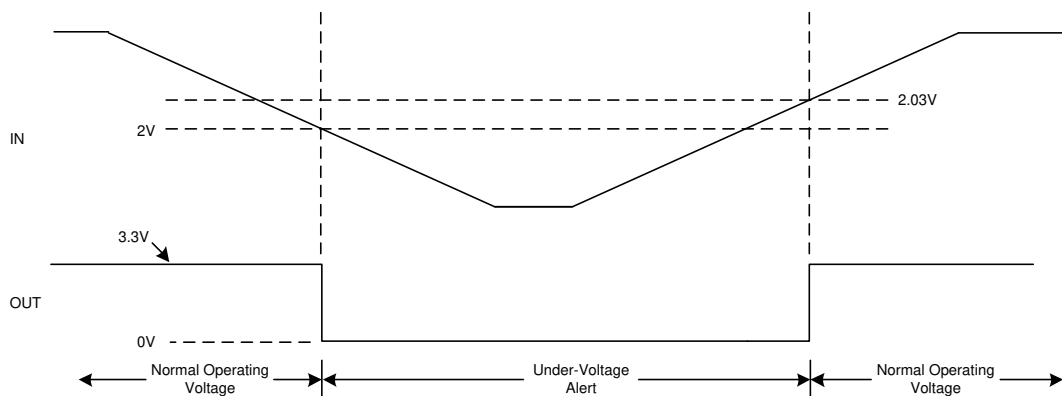
$$R_1 = \frac{(2.0 - 1.18)}{1.18} \times 1M = 695 \text{ k}\Omega \quad (3)$$

where

- $R_2$  is set to 1 M $\Omega$
- $V_{BAT}$  is set to 2.0 V
- $V_{IT-}$  is set to 1.18 V

Choose  $R_{TOTAL}$  ( $R_1 + R_2$ ) such that the current through the divider is at least 100 times higher than the input bias current ( $I_{BIAS}$ ). The resistors can have high values to minimize current consumption in the circuit without adding significant error to the resistive divider.

### 9.2.1.3 Application Curve



**Figure 9-5. Under-Voltage Detection**

## 9.2.2 Additional Application Information

### 9.2.2.1 Pull-up Resistor Selection

For the TLV4021 (open-drain output versions of the TLV40x1 family), care should be taken in selecting the pull-up resistor ( $R_{PU}$ ) value to ensure proper output voltage levels. First, consider the required output high logic level requirement of the logic device that is being driven by the comparator when calculating the maximum  $R_{PU}$  value. When in a logic high output state, the output impedance of the comparator is very high but there is a finite amount of leakage current that needs to be accounted for. Use  $I_{O-LKG}$  from the EC Table and the  $V_{IH}$  minimum from the logic device being driven to determine  $R_{PU}$  maximum using [Equation 4](#).

$$R_{PU(max)} = \frac{(V_{PU} - V_{IH(min)})}{I_{O-LKG}} \quad (4)$$

Next, determine the minimum value for  $R_{PU}$  by using the  $V_{IL}$  maximum from the logic device being driven. In order for the comparator output to be recognized as a logic low,  $V_{IL}$  maximum is used to determine the upper boundary of the comparator's  $V_{OL}$ .  $V_{OL}$  maximum for the comparator is available in the EC Table for specific sink current levels and can also be found from the  $V_{OUT}$  versus  $I_{SINK}$  curve in the Typical Application curves. A good design practice is to choose a value for  $V_{OL}$  maximum that is 1/2 the value of  $V_{IL}$  maximum for the input logic device. The corresponding sink current and  $V_{OL}$  maximum value will be needed to calculate the minimum  $R_{PU}$ . This method will ensure enough noise margin for the logic low level. With  $V_{OL}$  maximum determined and the corresponding  $I_{SINK}$  obtained, the minimum  $R_{PU}$  value is calculated with [Equation 5](#).

$$R_{PU(min)} = \frac{(V_{PU} - V_{OL(max)})}{I_{SINK}} \quad (5)$$

Since the range of possible  $R_{PU}$  values is large, a value between 5 k $\Omega$  and 100 k $\Omega$  is generally recommended. A smaller  $R_{PU}$  value provides faster output transition time and better noise immunity, while a larger  $R_{PU}$  value consumes less power when in a logic low output state.

#### 9.2.2.2 Input Supply Capacitor

Although an input capacitor is not required for stability, for good analog design practice, connect a 100 nF low equivalent series resistance (ESR) capacitor from (V+) to (V-).

#### 9.2.2.3 Sense Capacitor

Although not required in most cases, for extremely noisy applications, place a 1 nF to 100 nF bypass capacitor from the comparator input (IN) to the (V-) for good analog design practice. This capacitor placement reduces device sensitivity to transients.

## 9.3 What to Do and What Not to Do

Do connect a 100 nF decoupling capacitor from (V+) to (V-) for best system performance.

If the monitored voltage is noisy, do connect a decoupling capacitor from the comparator input (IN) to (V-).

Don't use resistors for the voltage divider that cause the current through them to be less than 100 times the input current of the comparator without also accounting for the impact on accuracy.

Don't use a pull-up resistor that is too small because the larger current sunk by the output may exceed the desired low-level output voltage ( $V_{OL}$ ).

## 10 Power Supply Recommendations

These devices operate from an input voltage supply range between 1.7 V and 5.5 V.

## 11 Layout

### 11.1 Layout Guidelines

A power supply bypass capacitor of 100 nF is recommended when supply output impedance is high, supply traces are long, or when excessive noise is expected on the supply lines. Bypass capacitors are also recommended when the comparator output drives a long trace or is required to drive a capacitive load. Due to the fast rising and falling edge rates and high-output sink and source capability of the TLV40x1 output stage, higher than normal quiescent current can be drawn from the power supply when the output transitions. Under this circumstance, the system would benefit from a bypass capacitor across the supply pins.

### 11.2 Layout Example

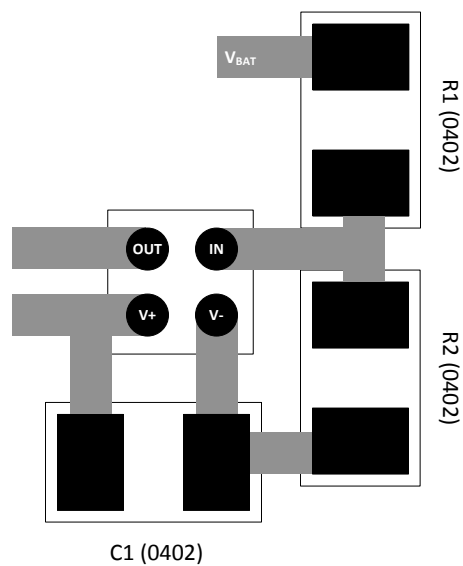


Figure 11-1. Layout Example



## 12 Device and Documentation Support

### 12.1 Receiving Notification of Documentation Updates

To receive notification of documentation updates, navigate to the device product folder on [ti.com](http://ti.com). Click on *Subscribe to updates* to register and receive a weekly digest of any product information that has changed. For change details, review the revision history included in any revised document.

### 12.2 Support Resources

[TI E2E™ support forums](#) are an engineer's go-to source for fast, verified answers and design help — straight from the experts. Search existing answers or ask your own question to get the quick design help you need.

Linked content is provided "AS IS" by the respective contributors. They do not constitute TI specifications and do not necessarily reflect TI's views; see TI's [Terms of Use](#).

### 12.3 Trademarks

TI E2E™ is a trademark of Texas Instruments.

All trademarks are the property of their respective owners.

### 12.4 Electrostatic Discharge Caution



This integrated circuit can be damaged by ESD. Texas Instruments recommends that all integrated circuits be handled with appropriate precautions. Failure to observe proper handling and installation procedures can cause damage.

ESD damage can range from subtle performance degradation to complete device failure. Precision integrated circuits may be more susceptible to damage because very small parametric changes could cause the device not to meet its published specifications.

### 12.5 Glossary

[TI Glossary](#) This glossary lists and explains terms, acronyms, and definitions.

## 13 Mechanical, Packaging, and Orderable Information

The following pages include mechanical, packaging, and orderable information. This information is the most current data available for the designated devices. This data is subject to change without notice and revision of this document. For browser-based versions of this data sheet, refer to the left-hand navigation.

## PACKAGING INFORMATION

Orderable Device	Status (1)	Package Type	Package Drawing	Pins	Package Qty	Eco Plan (2)	Lead finish/ Ball material (6)	MSL Peak Temp (3)	Op Temp (°C)	Device Marking (4/5)	Samples
TLV4021R1YKAR	ACTIVE	DSBGA	YKA	4	3000	RoHS & Green	SNAGCU	Level-1-260C-UNLIM	-40 to 125	Z	<a href="#">Samples</a>
TLV4021R2YKAR	ACTIVE	DSBGA	YKA	4	3000	RoHS & Green	SNAGCU	Level-1-260C-UNLIM	-40 to 125	6	<a href="#">Samples</a>
TLV4021S5MYKAR	ACTIVE	DSBGA	YKA	4	3000	RoHS & Green	SNAGCU	Level-1-260C-UNLIM	-40 to 125	Q	<a href="#">Samples</a>
TLV4021S5YKAR	ACTIVE	DSBGA	YKA	4	3000	RoHS & Green	SAC396   SNAGCU	Level-1-260C-UNLIM	-40 to 125	O	<a href="#">Samples</a>
TLV4031R1YKAR	ACTIVE	DSBGA	YKA	4	3000	RoHS & Green	SNAGCU	Level-1-260C-UNLIM	-40 to 125	1	<a href="#">Samples</a>
TLV4031R2YKAR	ACTIVE	DSBGA	YKA	4	3000	RoHS & Green	SNAGCU	Level-1-260C-UNLIM	-40 to 125	7	<a href="#">Samples</a>
TLV4041R1YKAR	ACTIVE	DSBGA	YKA	4	3000	RoHS & Green	SNAGCU	Level-1-260C-UNLIM	-40 to 125	2	<a href="#">Samples</a>
TLV4041R2YKAR	ACTIVE	DSBGA	YKA	4	3000	RoHS & Green	SNAGCU	Level-1-260C-UNLIM	-40 to 125	8	<a href="#">Samples</a>
TLV4041R5DBVR	ACTIVE	SOT-23	DBV	5	3000	RoHS & Green	NIPDAU	Level-1-260C-UNLIM	-40 to 125	23XT	<a href="#">Samples</a>
TLV4041R5YKAR	ACTIVE	DSBGA	YKA	4	3000	RoHS & Green	SNAGCU	Level-1-260C-UNLIM	-40 to 125	A	<a href="#">Samples</a>
TLV4051R1YKAR	ACTIVE	DSBGA	YKA	4	3000	RoHS & Green	SNAGCU	Level-1-260C-UNLIM	-40 to 125	C	<a href="#">Samples</a>
TLV4051R2YKAR	ACTIVE	DSBGA	YKA	4	3000	RoHS & Green	SNAGCU	Level-1-260C-UNLIM	-40 to 125	9	<a href="#">Samples</a>
TLV4051R5DBVR	ACTIVE	SOT-23	DBV	5	3000	RoHS & Green	NIPDAU	Level-1-260C-UNLIM	-40 to 125	23ZT	<a href="#">Samples</a>

(1) The marketing status values are defined as follows:

**ACTIVE:** Product device recommended for new designs.

**LIFEBUY:** TI has announced that the device will be discontinued, and a lifetime-buy period is in effect.

**NRND:** Not recommended for new designs. Device is in production to support existing customers, but TI does not recommend using this part in a new design.

**PREVIEW:** Device has been announced but is not in production. Samples may or may not be available.

**OBSELETE:** TI has discontinued the production of the device.

(2) **RoHS:** TI defines "RoHS" to mean semiconductor products that are compliant with the current EU RoHS requirements for all 10 RoHS substances, including the requirement that RoHS substance do not exceed 0.1% by weight in homogeneous materials. Where designed to be soldered at high temperatures, "RoHS" products are suitable for use in specified lead-free processes. TI may reference these types of products as "Pb-Free".

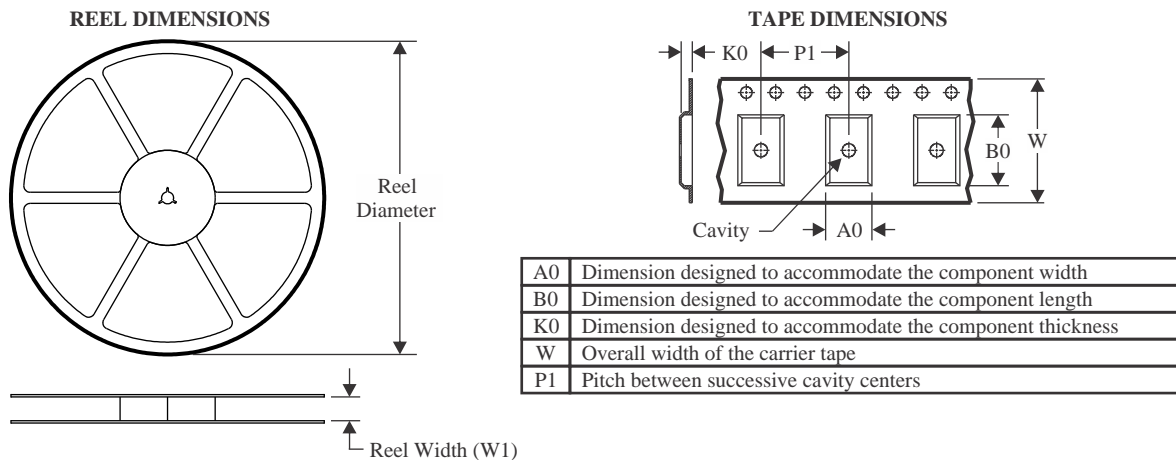
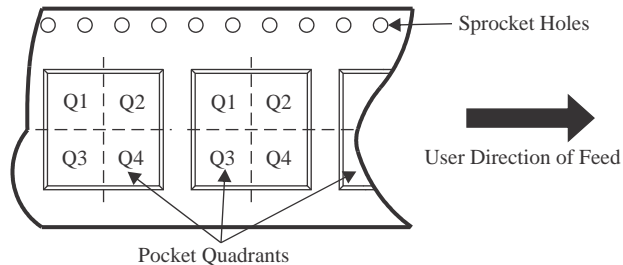
**RoHS Exempt:** TI defines "RoHS Exempt" to mean products that contain lead but are compliant with EU RoHS pursuant to a specific EU RoHS exemption.

**Green:** TI defines "Green" to mean the content of Chlorine (Cl) and Bromine (Br) based flame retardants meet JS709B low halogen requirements of <=1000ppm threshold. Antimony trioxide based flame retardants must also meet the <=1000ppm threshold requirement.

- (3) MSL, Peak Temp. - The Moisture Sensitivity Level rating according to the JEDEC industry standard classifications, and peak solder temperature.
- (4) There may be additional marking, which relates to the logo, the lot trace code information, or the environmental category on the device.
- (5) Multiple Device Markings will be inside parentheses. Only one Device Marking contained in parentheses and separated by a "~" will appear on a device. If a line is indented then it is a continuation of the previous line and the two combined represent the entire Device Marking for that device.
- (6) Lead finish/Ball material - Orderable Devices may have multiple material finish options. Finish options are separated by a vertical ruled line. Lead finish/Ball material values may wrap to two lines if the finish value exceeds the maximum column width.

**Important Information and Disclaimer:**The information provided on this page represents TI's knowledge and belief as of the date that it is provided. TI bases its knowledge and belief on information provided by third parties, and makes no representation or warranty as to the accuracy of such information. Efforts are underway to better integrate information from third parties. TI has taken and continues to take reasonable steps to provide representative and accurate information but may not have conducted destructive testing or chemical analysis on incoming materials and chemicals. TI and TI suppliers consider certain information to be proprietary, and thus CAS numbers and other limited information may not be available for release.

In no event shall TI's liability arising out of such information exceed the total purchase price of the TI part(s) at issue in this document sold by TI to Customer on an annual basis.

**TAPE AND REEL INFORMATION**

**QUADRANT ASSIGNMENTS FOR PIN 1 ORIENTATION IN TAPE**


\*All dimensions are nominal

Device	Package Type	Package Drawing	Pins	SPQ	Reel Diameter (mm)	Reel Width W1 (mm)	A0 (mm)	B0 (mm)	K0 (mm)	P1 (mm)	W (mm)	Pin1 Quadrant
TLV4021R1YKAR	DSBGA	YKA	4	3000	180.0	8.4	0.84	0.84	0.48	4.0	8.0	Q1
TLV4021R2YKAR	DSBGA	YKA	4	3000	180.0	8.4	0.84	0.84	0.48	4.0	8.0	Q1
TLV4021S5MYKAR	DSBGA	YKA	4	3000	180.0	8.4	0.84	0.84	0.48	4.0	8.0	Q1
TLV4021S5YKAR	DSBGA	YKA	4	3000	180.0	8.4	0.84	0.84	0.48	4.0	8.0	Q1
TLV4021S5YKAR	DSBGA	YKA	4	3000	180.0	8.4	0.84	0.84	0.48	4.0	8.0	Q1
TLV4031R1YKAR	DSBGA	YKA	4	3000	180.0	8.4	0.84	0.84	0.48	4.0	8.0	Q1
TLV4031R2YKAR	DSBGA	YKA	4	3000	180.0	8.4	0.84	0.84	0.48	4.0	8.0	Q1
TLV4041R1YKAR	DSBGA	YKA	4	3000	180.0	8.4	0.84	0.84	0.48	4.0	8.0	Q1
TLV4041R2YKAR	DSBGA	YKA	4	3000	180.0	8.4	0.84	0.84	0.48	4.0	8.0	Q1
TLV4041R5DBVR	SOT-23	DBV	5	3000	178.0	9.0	2.4	2.5	1.2	4.0	8.0	Q3
TLV4041R5YKAR	DSBGA	YKA	4	3000	180.0	8.4	0.84	0.84	0.48	4.0	8.0	Q1
TLV4051R1YKAR	DSBGA	YKA	4	3000	180.0	8.4	0.84	0.84	0.48	4.0	8.0	Q1
TLV4051R2YKAR	DSBGA	YKA	4	3000	180.0	8.4	0.84	0.84	0.48	4.0	8.0	Q1
TLV4051R5DBVR	SOT-23	DBV	5	3000	178.0	9.0	2.4	2.5	1.2	4.0	8.0	Q3

**TAPE AND REEL BOX DIMENSIONS**


\*All dimensions are nominal

Device	Package Type	Package Drawing	Pins	SPQ	Length (mm)	Width (mm)	Height (mm)
TLV4021R1YKAR	DSBGA	YKA	4	3000	182.0	182.0	20.0
TLV4021R2YKAR	DSBGA	YKA	4	3000	182.0	182.0	20.0
TLV4021S5MYKAR	DSBGA	YKA	4	3000	182.0	182.0	20.0
TLV4021S5YKAR	DSBGA	YKA	4	3000	182.0	182.0	20.0
TLV4021S5YKAR	DSBGA	YKA	4	3000	182.0	182.0	20.0
TLV4031R1YKAR	DSBGA	YKA	4	3000	182.0	182.0	20.0
TLV4031R2YKAR	DSBGA	YKA	4	3000	182.0	182.0	20.0
TLV4041R1YKAR	DSBGA	YKA	4	3000	182.0	182.0	20.0
TLV4041R2YKAR	DSBGA	YKA	4	3000	182.0	182.0	20.0
TLV4041R5DBVR	SOT-23	DBV	5	3000	180.0	180.0	18.0
TLV4041R5YKAR	DSBGA	YKA	4	3000	182.0	182.0	20.0
TLV4051R1YKAR	DSBGA	YKA	4	3000	182.0	182.0	20.0
TLV4051R2YKAR	DSBGA	YKA	4	3000	182.0	182.0	20.0
TLV4051R5DBVR	SOT-23	DBV	5	3000	180.0	180.0	18.0

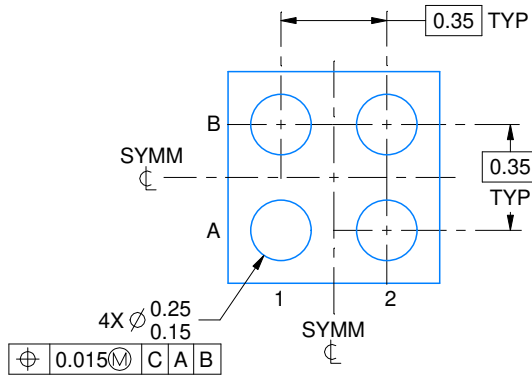
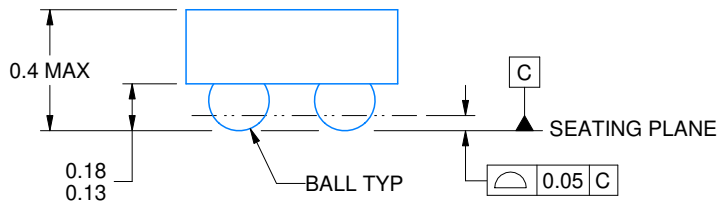
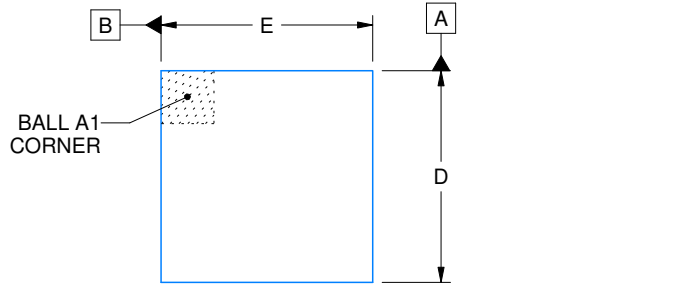
YKA0004



# PACKAGE OUTLINE

## DSBGA - 0.4 mm max height

DIE SIZE BALL GRID ARRAY



D: Max = 0.76 mm, Min = 0.7 mm
E: Max = 0.76 mm, Min = 0.7 mm

4221909/B 08/2018

NOTES:

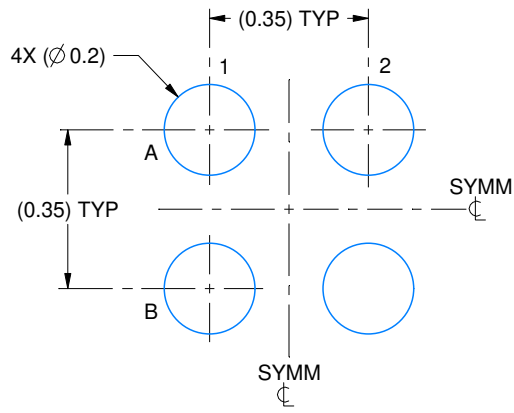
1. All linear dimensions are in millimeters. Any dimensions in parenthesis are for reference only. Dimensioning and tolerancing per ASME Y14.5M.
2. This drawing is subject to change without notice.

# EXAMPLE BOARD LAYOUT

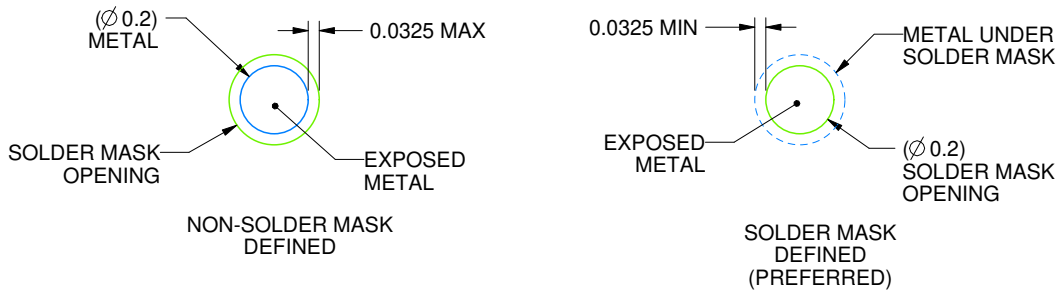
YKA0004

DSBGA - 0.4 mm max height

DIE SIZE BALL GRID ARRAY



LAND PATTERN EXAMPLE  
EXPOSED METAL SHOWN  
SCALE:60X



SOLDER MASK DETAILS  
NOT TO SCALE

4221909/B 08/2018

NOTES: (continued)

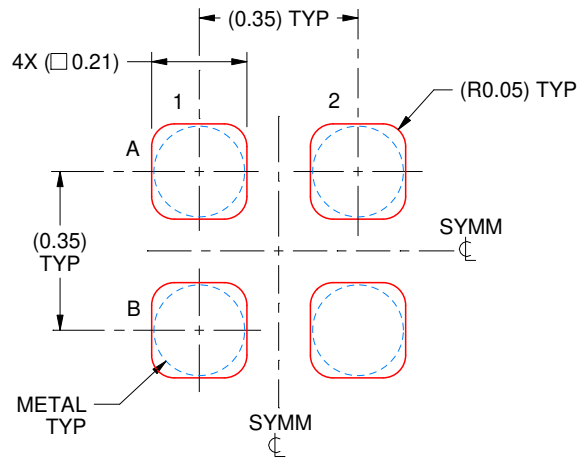
- Final dimensions may vary due to manufacturing tolerance considerations and also routing constraints. For more information, see Texas Instruments literature number SNVA009 ([www.ti.com/lit/snva009](http://www.ti.com/lit/snva009)).

# EXAMPLE STENCIL DESIGN

YKA0004

DSBGA - 0.4 mm max height

DIE SIZE BALL GRID ARRAY



SOLDER PASTE EXAMPLE  
BASED ON 0.075 mm - 0.1 mm THICK STENCIL  
SCALE:60X

4221909/B 08/2018

NOTES: (continued)

4. Laser cutting apertures with trapezoidal walls and rounded corners may offer better paste release.



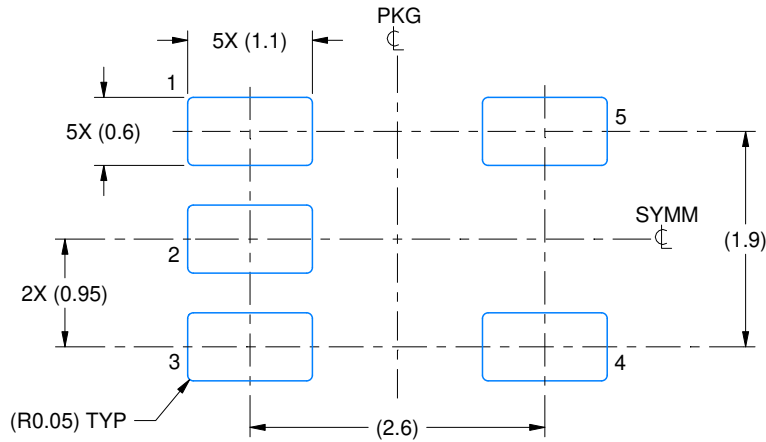


# EXAMPLE BOARD LAYOUT

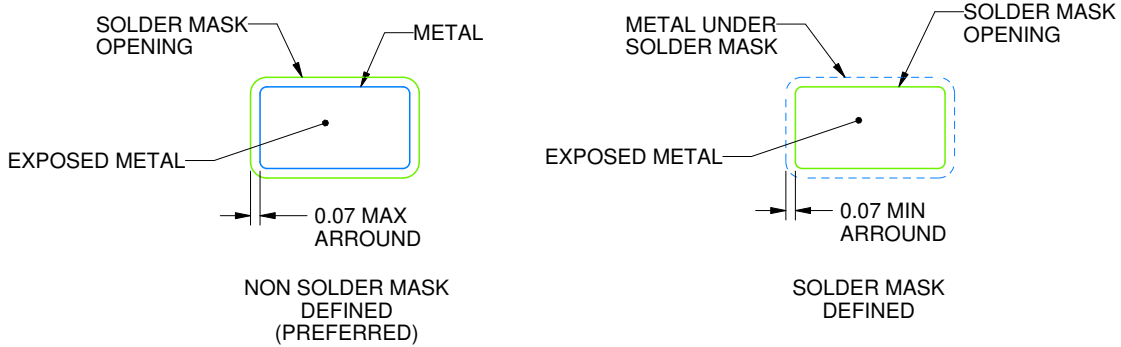
DBV0005A

SOT-23 - 1.45 mm max height

SMALL OUTLINE TRANSISTOR



LAND PATTERN EXAMPLE  
EXPOSED METAL SHOWN  
SCALE:15X



SOLDER MASK DETAILS

4214839/H 09/2023

NOTES: (continued)

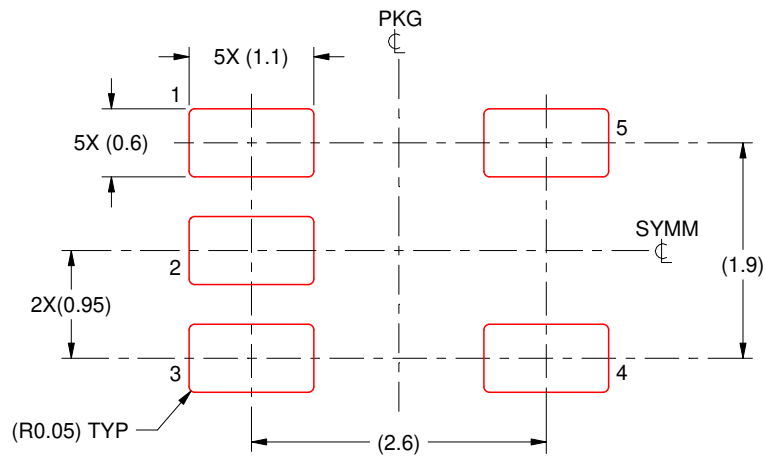
6. Publication IPC-7351 may have alternate designs.
7. Solder mask tolerances between and around signal pads can vary based on board fabrication site.

# EXAMPLE STENCIL DESIGN

DBV0005A

SOT-23 - 1.45 mm max height

SMALL OUTLINE TRANSISTOR



SOLDER PASTE EXAMPLE  
BASED ON 0.125 mm THICK STENCIL  
SCALE:15X

4214839/H 09/2023

NOTES: (continued)

8. Laser cutting apertures with trapezoidal walls and rounded corners may offer better paste release. IPC-7525 may have alternate design recommendations.
9. Board assembly site may have different recommendations for stencil design.

## IMPORTANT NOTICE AND DISCLAIMER

TI PROVIDES TECHNICAL AND RELIABILITY DATA (INCLUDING DATA SHEETS), DESIGN RESOURCES (INCLUDING REFERENCE DESIGNS), APPLICATION OR OTHER DESIGN ADVICE, WEB TOOLS, SAFETY INFORMATION, AND OTHER RESOURCES "AS IS" AND WITH ALL FAULTS, AND DISCLAIMS ALL WARRANTIES, EXPRESS AND IMPLIED, INCLUDING WITHOUT LIMITATION ANY IMPLIED WARRANTIES OF MERCHANTABILITY, FITNESS FOR A PARTICULAR PURPOSE OR NON-INFRINGEMENT OF THIRD PARTY INTELLECTUAL PROPERTY RIGHTS.

These resources are intended for skilled developers designing with TI products. You are solely responsible for (1) selecting the appropriate TI products for your application, (2) designing, validating and testing your application, and (3) ensuring your application meets applicable standards, and any other safety, security, regulatory or other requirements.

These resources are subject to change without notice. TI grants you permission to use these resources only for development of an application that uses the TI products described in the resource. Other reproduction and display of these resources is prohibited. No license is granted to any other TI intellectual property right or to any third party intellectual property right. TI disclaims responsibility for, and you will fully indemnify TI and its representatives against, any claims, damages, costs, losses, and liabilities arising out of your use of these resources.

TI's products are provided subject to [TI's Terms of Sale](#) or other applicable terms available either on [ti.com](https://www.ti.com) or provided in conjunction with such TI products. TI's provision of these resources does not expand or otherwise alter TI's applicable warranties or warranty disclaimers for TI products.

TI objects to and rejects any additional or different terms you may have proposed.

Mailing Address: Texas Instruments, Post Office Box 655303, Dallas, Texas 75265  
Copyright © 2023, Texas Instruments Incorporated