



soberton inc.

# WSP WATER RESISTANT SPEAKER

Acoustic Product Specification

Product Number: WSP-5708



Release | Revision: A/2018

## CONTENTS

This document contains the technical specifications for the water resistant speaker

### Page 1

Specifications

Dimensions

Frequency Response

## Specifications

Specification	Unit	WSP-5708
AC Impedance	$\Omega$	8 $\pm$ 15% at 2000Hz
Rated Input Power	Watt	3.0
Max Input Power	Watt	4.0
Resonant Frequency	Hz	710 $\pm$ 20%
Frequency Range	Hz	F0~9.0KHz, average SPL $\pm$ 10dB
Output Sound Pressure Level	dB	100 $\pm$ 3dB 0.1 Watt/10 cm, AVG. at 0.8, 1.0, 1.2, 1.5KHz
Operating Temperature	$^{\circ}$ C	-20 $^{\circ}$ C ~ +50 $^{\circ}$ C
Storage Temperature	$^{\circ}$ C	-40 $^{\circ}$ C ~ +60 $^{\circ}$ C
Dimension	mm	$\varnothing$ 56.8 x H13.2
Distortion		5% maximum at 1000Hz, 3.0W
Polarity		Diaphragm shall move forward when a positive DC current is applied to the "+" or "Marked" terminal
Load Test		Audio Signal Generator at 4.9 Volt Total 48hrs and 20Hz ~ 20KHz resonant frequency
Abnormal Sound Test		Must be normal tested at 4.9Volt sine wave
Ingress Rating		IP65

## Dimensions

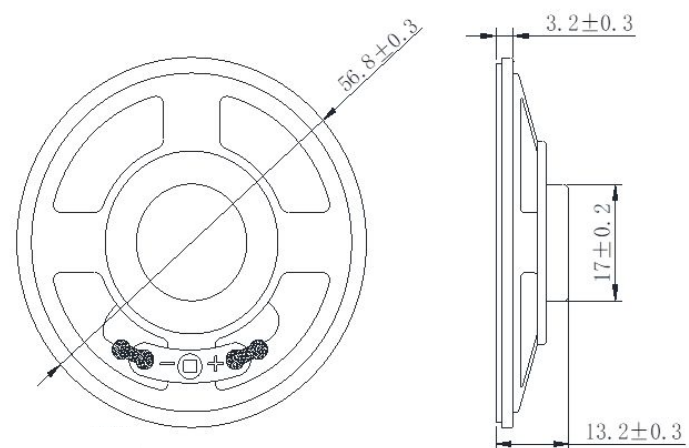

Unit: mm

## Frequency Response

