

Enhanced Product

High Stability, Low Noise Vibration Rejecting Yaw Rate Gyroscope

FEATURES

- ▶ 12°/hr bias stability
- ▶ Z-axis (yaw rate) response
- ▶ 0.01°/√sec angle random walk
- ▶ High vibration rejection over wide frequency
- ▶ Measurement range extendable to a maximum of ±450°/sec
- ▶ 10,000 g powered shock survivability
- ▶ Ratiometric to referenced supply
- ▶ 6 V single-supply operation
- ▶ Self-test on digital command
- ▶ Ultrasmall and light (<0.15 cc, <0.5 gram)
- ▶ Temperature sensor output
- ▶ Complete rate gyroscope on a single chip
- ▶ RoHS compliant

ENHANCED PRODUCT FEATURES

- ▶ Supports defense and aerospace applications
- ▶ Extended industrial temperature range (-55°C to +105°C)
- ▶ Controlled manufacturing baseline
- ▶ 1 assembly/test site
- ▶ 1 fabrication site
- ▶ Enhanced product change notification
- ▶ Qualification data available on request

APPLICATIONS

- ▶ Industrial applications
- ▶ Severe mechanical environments
- ▶ Platform stabilization

FUNCTIONAL BLOCK DIAGRAM

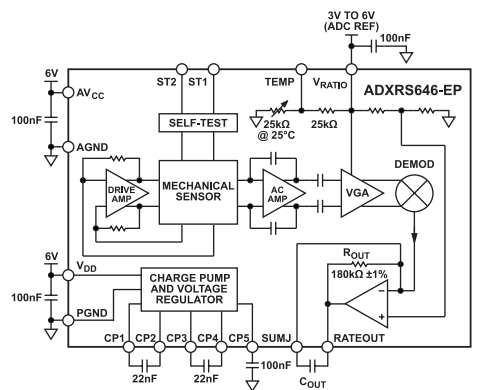

Figure 1.

GENERAL DESCRIPTION

The ADXRS646-EP is a high performance angular rate sensor (gyroscope) that offers excellent vibration immunity. Bias stability is a widely recognized figure of merit for high performance gyroscopes, but in real-world applications, vibration sensitivity is often a more significant performance limitation and should be considered in gyroscope selection. The ADXRS646-EP offers superior vibration immunity and acceleration rejection as well as a low bias drift of 12°/hr (typical), enabling it to offer rate sensing in harsh environments where shock and vibration are present.

The ADXRS646-EP is manufactured using the Analog Devices, Inc., patented high volume BiMOS surface-micromachining process. An advanced, differential, quad sensor design provides the improved acceleration and vibration rejection. The output signal, RATEOUT, is a voltage proportional to angular rate about the axis normal to the top surface of the package. The measurement range is a minimum of ±250°/sec. The output is ratiometric with respect to a provided reference supply. Other external capacitors are required for operation.

A temperature output is provided for compensation techniques. Two digital self-test inputs electromechanically excite the sensor to test proper operation of both the sensor and the signal conditioning circuits.

The ADXRS646-EP is available in a 7 mm × 7 mm × 3 mm CBGA chip scale package. Additional application and technical information can be found in the [ADXRS646](#) data sheet.

TABLE OF CONTENTS

Features.....	1	Rate Sensitive Axis.....	5
Enhanced Product Features.....	1	ESD Caution.....	5
Applications.....	1	Pin Configuration and Function Descriptions.....	6
General Description.....	1	Typical Performance Characteristics.....	7
Functional Block Diagram.....	1	Outline Dimensions.....	10
Specifications.....	3	Ordering Guide.....	10
Absolute Maximum Ratings.....	5		

REVISION HISTORY**3/2022—Rev. A to Rev. B**

Change to Figure 6 Caption.....	7
---------------------------------	---

SPECIFICATIONS

All minimum and maximum specifications are guaranteed. Typical specifications are not guaranteed.

$T_A = 25^\circ\text{C}$, $V_S = AV_{CC} = V_{DD} = 6\text{ V}$, $V_{RATIO} = AV_{CC}$, angular rate = $0^\circ/\text{sec}$, bandwidth = 80 Hz ($C_{OUT} = 0.01\ \mu\text{F}$), $I_{OUT} = 100\ \mu\text{A}$, $\pm 1\text{ g}$, unless otherwise noted.

Table 1.

Parameter	Test Conditions/Comments	Min	Typ	Max	Unit
SENSITIVITY ¹	Clockwise rotation is positive output				
Measurement Range ²	Full-scale range over specifications range	± 250	± 300		$^\circ/\text{sec}$
Initial		8.5	9	9.5	$\text{mV}/^\circ/\text{sec}$
Temperature Drift ³			± 3		%
Nonlinearity	Best fit straight line		0.01		% of FS
NULL ¹					
Null	-40°C to $+105^\circ\text{C}$	2.7	3.0	3.3	V
Temperature Drift ³			± 3		$^\circ/\text{sec}$
Linear Acceleration Effect	Any axis		0.015		$^\circ/\text{sec}/\text{g}$
Vibration Rectification	25 g rms, 50 Hz to 5 kHz		0.0001		$^\circ/\text{sec}/\text{g}^2$
NOISE PERFORMANCE					
Rate Noise Density	$T_A \leq 25^\circ\text{C}$		0.01		$^\circ/\text{sec}/\sqrt{\text{Hz}}$
Rate Noise Density	$T_A \leq 105^\circ\text{C}$		0.015		$^\circ/\text{sec}/\sqrt{\text{Hz}}$
Resolution Floor	$T_A = 25^\circ\text{C}$, 1 minute to 1 hour in-run		12		$^\circ/\text{hr}$
FREQUENCY RESPONSE					
Bandwidth ⁴	$\pm 3\text{ dB}$ user adjustable up to specification		1000		Hz
Sensor Resonant Frequency		15.5	17.5	20	kHz
SELF-TEST ¹					
ST1 RATEOUT Response	ST1 pin from Logic 0 to Logic 1		-50		$^\circ/\text{sec}$
ST2 RATEOUT Response	ST2 pin from Logic 0 to Logic 1		50		$^\circ/\text{sec}$
ST1 to ST2 Mismatch ⁵		-5	± 0.5	+5	%
Logic 1 Input Voltage	ST1 pin or ST2 pin	4			V
Logic 0 Input Voltage				2	V
Input Impedance	ST1 pin or ST2 pin to common	40	50	100	k Ω
TEMPERATURE SENSOR ¹					
V_{OUT} at 25°C	Load = 10 M Ω	2.8	2.9	3.0	V
Scale Factor ⁶	25°C , $V_{RATIO} = 6\text{ V}$		10		$\text{mV}/^\circ\text{C}$
Load to V_S			25		k Ω
Load to Common			25		k Ω
TURN-ON TIME ⁶	Power on to $\pm 0.5^\circ/\text{sec}$ of final with CP5 = 100 nF			50	ms
OUTPUT DRIVE CAPABILITY					
Current Drive	For rated specifications			200	μA
Capacitive Load Drive				1000	pF
POWER SUPPLY					
Operating Voltage (V_S)		5.75	6.00	6.25	V
Quiescent Supply Current			4		mA
TEMPERATURE RANGE					
Specified Performance		-55		+105	$^\circ\text{C}$

¹ Parameter is linearly ratiometric with V_{RATIO} .

² Measurement range is the maximum range possible, including output swing range, initial offset, sensitivity, offset drift, and sensitivity drift at 5 V supplies.

³ From $+25^\circ\text{C}$ to -40°C or $+25^\circ\text{C}$ to $+105^\circ\text{C}$.

⁴ Adjusted by external capacitor, C_{OUT} . Reducing bandwidth below 0.01 Hz does not result in further noise improvement.

⁵ Self-test mismatch is described as $(ST2 + ST1)/((ST2 - ST1)/2)$.

SPECIFICATIONS**Table 1.**

Parameter	Test Conditions/Comments	Min	Typ	Max	Unit
-----------	--------------------------	-----	-----	-----	------

⁶ Based on characterization.

ABSOLUTE MAXIMUM RATINGS

Table 2.

Parameter	Rating
Acceleration (Any Axis, 0.5 ms)	
Unpowered	10,000 g
Powered	10,000 g
V_{DD} , AV_{CC}	-0.3 V to +6.6 V
V_{RATIO}	AV_{CC}
ST1, ST2	AV_{CC}
Output Short-Circuit Duration (Any Pin to Common)	Indefinite
Operating Temperature Range	-65°C to +125°C
Storage Temperature Range	-65°C to +150°C

Stresses at or above those listed under the Absolute Maximum Ratings may cause permanent damage to the product. This is a stress rating only; functional operation of the product at these or any other conditions above those indicated in the operational section of this specification is not implied. Operation beyond the maximum operating conditions for extended periods may affect product reliability.

Drops onto hard surfaces can cause shocks of greater than 10,000 g and can exceed the absolute maximum rating of the device. Care should be exercised in handling to avoid damage.

RATE SENSITIVE AXIS

This is a Z-axis rate-sensing device (also called a yaw rate-sensing device). It produces a positive going output voltage for clockwise rotation about the axis normal to the package top, that is, clockwise when looking down at the package lid.

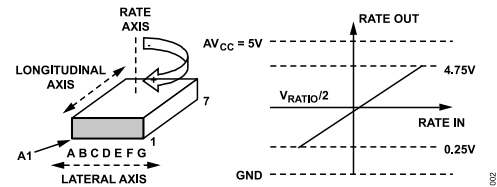

Figure 2. RATEOUT Signal Increases with Clockwise Rotation

ESD CAUTION



ESD (electrostatic discharge) sensitive device. Charged devices and circuit boards can discharge without detection. Although this product features patented or proprietary protection circuitry, damage may occur on devices subjected to high energy ESD. Therefore, proper ESD precautions should be taken to avoid performance degradation or loss of functionality.

PIN CONFIGURATION AND FUNCTION DESCRIPTIONS

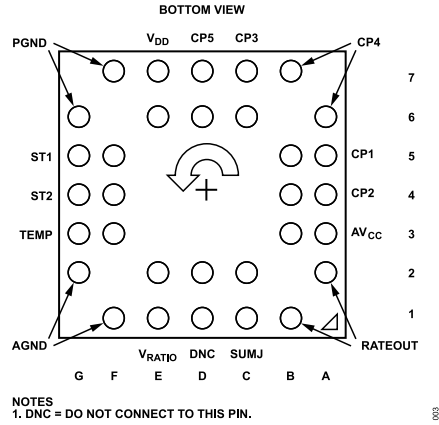

Figure 3. Pin Configuration

Table 3. Pin Function Descriptions

Pin No.	Mnemonic	Description
6D, 7D	CP5	HV Filter Capacitor, 100 nF (±5%).
6A, 7B	CP4	Charge Pump Capacitor, 22 nF (±5%).
6C, 7C	CP3	Charge Pump Capacitor, 22 nF (±5%).
5A, 5B	CP1	Charge Pump Capacitor, 22 nF (±5%).
4A, 4B	CP2	Charge Pump Capacitor, 22 nF (±5%).
3A, 3B	AV _{CC}	Positive Analog Supply.
1B, 2A	RATEOUT	Rate Signal Output.
1C, 2C	SUMJ	Output Amp Summing Junction.
1D, 2D	DNC	Do Not Connect to this Pin.
1E, 2E	V _{RATIO}	Reference Supply for Ratiometric Output.
1F, 2G	AGND	Analog Supply Return.
3F, 3G	TEMP	Temperature Voltage Output.
4F, 4G	ST2	Self-Test for Sensor 2.
5F, 5G	ST1	Self-Test for Sensor 1.
6G, 7F	PGND	Charge Pump Supply Return.
6E, 7E	V _{DD}	Positive Charge Pump Supply.

TYPICAL PERFORMANCE CHARACTERISTICS

N > 1000 for all typical performance plots, unless otherwise noted.

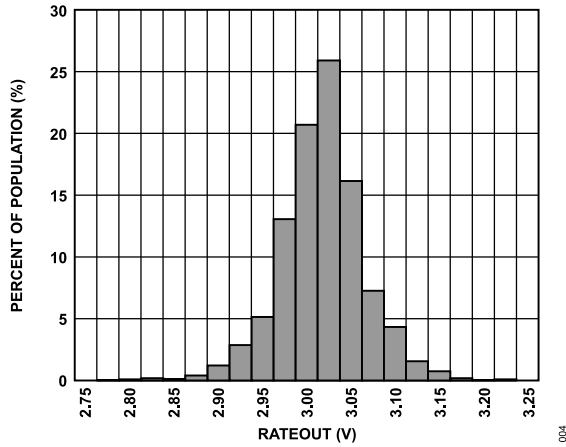

Figure 4. Null Bias at 25°C

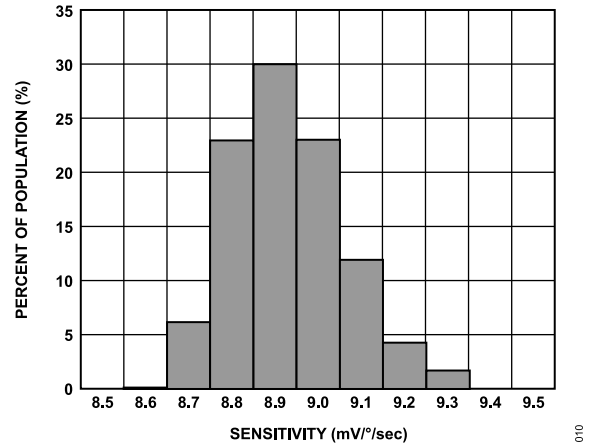

Figure 7. Sensitivity at 25°C

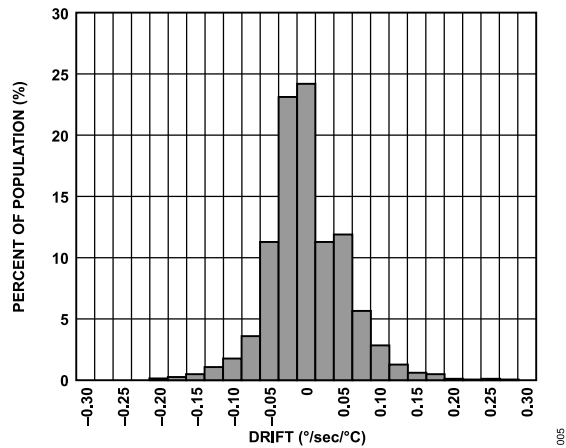

Figure 5. Null Drift over Temperature ($V_{RATIO} = 5 V$)

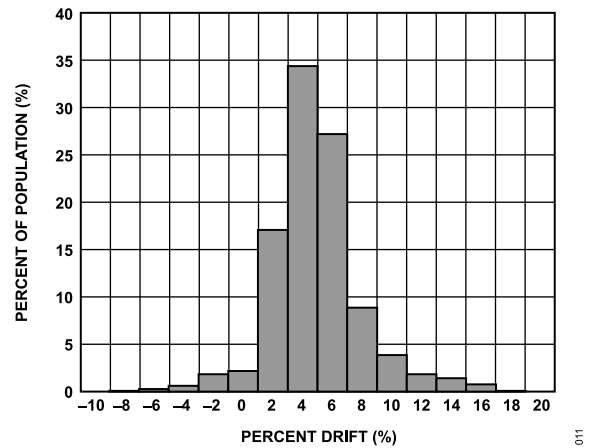

Figure 8. Sensitivity Drift over Temperature

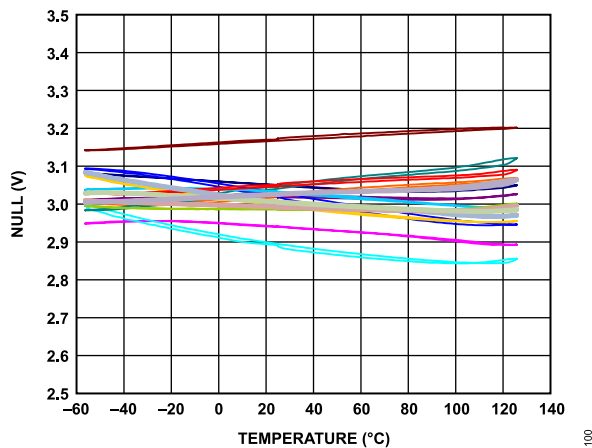

Figure 6. Null Output over Temperature, 16 Parts in Sockets ($V_{RATIO} = 6 V$)

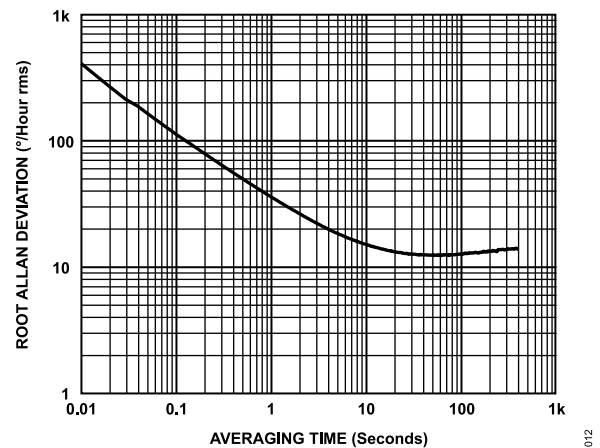

Figure 9. Typical Root Allan Deviation at 25°C vs. Averaging Time

TYPICAL PERFORMANCE CHARACTERISTICS

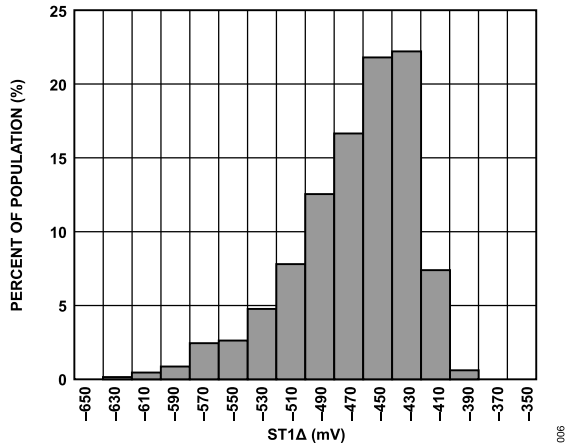

Figure 10. ST1 Output Change at 25°C ($V_{RATIO} = 5 V$)

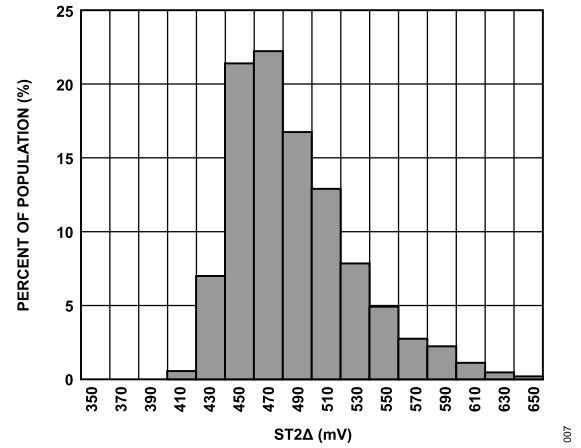

Figure 13. ST2 Output Change at 25°C ($V_{RATIO} = 5 V$)

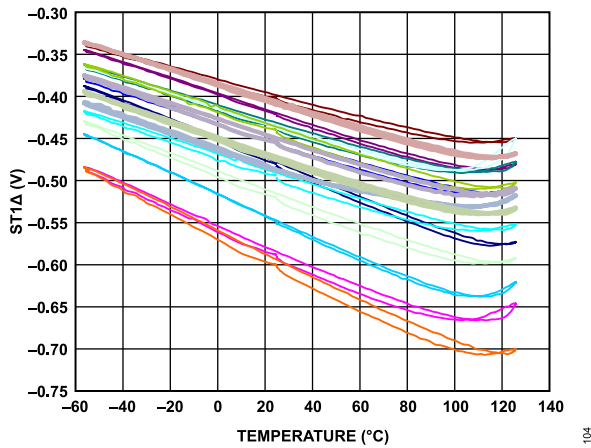

Figure 11. ST1 Output Change vs. Temperature, 16 Parts in Sockets

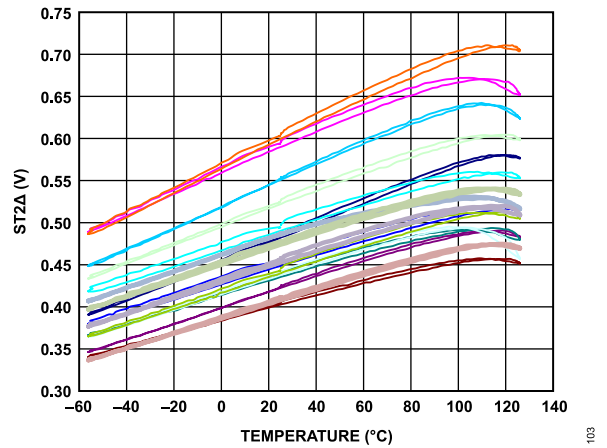

Figure 14. ST2 Output Change vs. Temperature, 16 Parts in Sockets

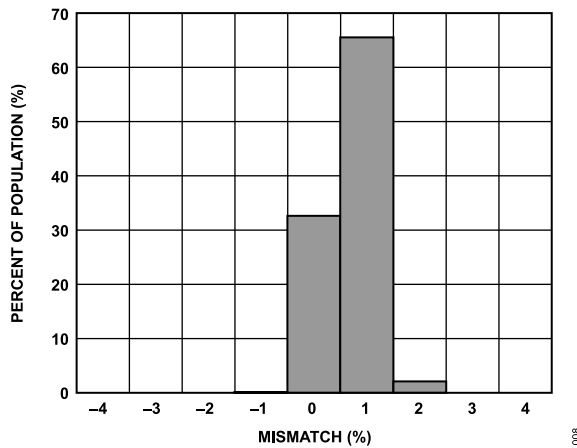

Figure 12. Self-Test Mismatch at 25°C ($V_{RATIO} = 5 V$)

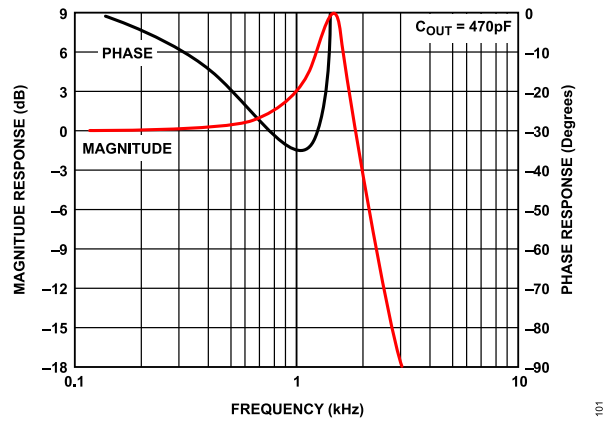

Figure 15. ADXRS646-EP Frequency Response with a 2.2 kHz Output Filter

TYPICAL PERFORMANCE CHARACTERISTICS

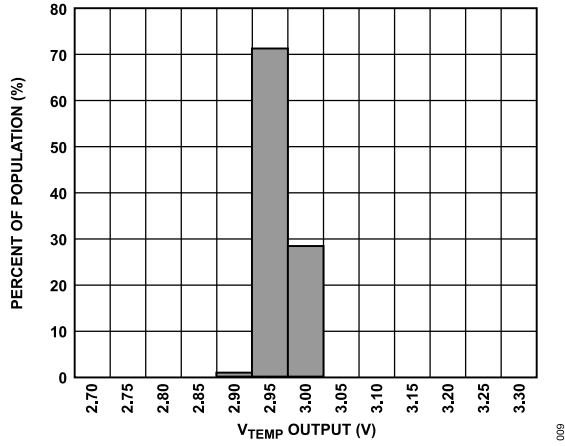

Figure 16. V_{TEMP} Output at 25°C (V_{RATIO} = 5 V)

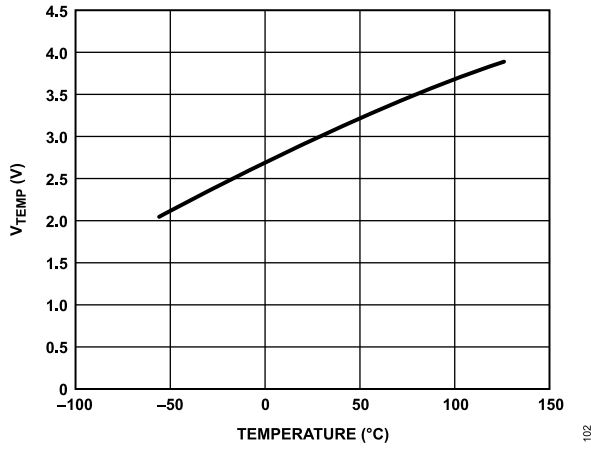

Figure 17. V_{TEMP} Output vs. Temperature

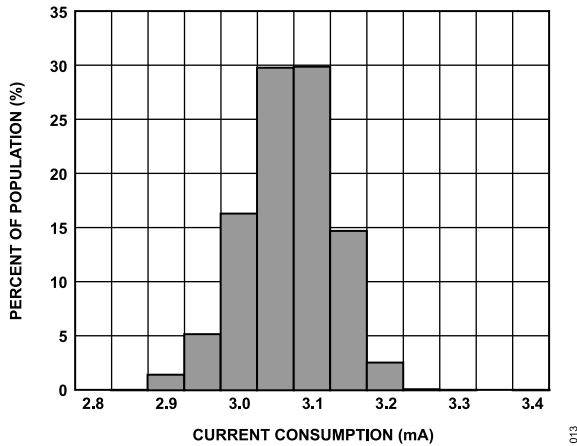
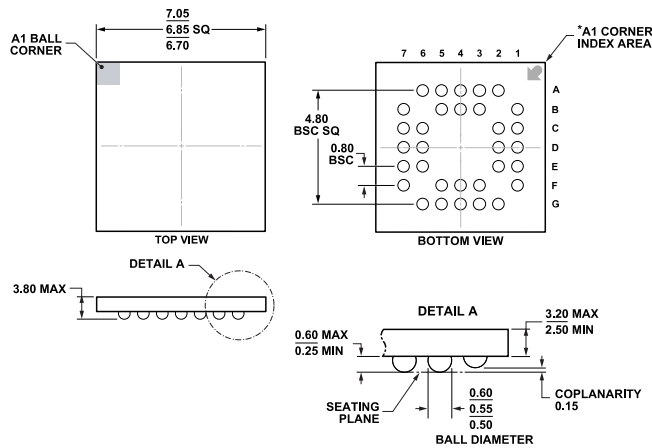

Figure 18. Current Consumption at 25°C (V_{RATIO} = 5 V)

OUTLINE DIMENSIONS



*BALL A1 IDENTIFIER IS GOLD PLATED AND CONNECTED TO THE D/A PAD INTERNALLY VIA HOLES.

07/15/2016

Figure 19. 32-Lead Ceramic Ball Grid Array [CBGA] (BG-32-3)
 Dimensions shown in millimeters

Updated: February 23, 2022

ORDERING GUIDE

Model ¹	Temperature Range	Package Description	Packing Quantity	Package Option
ADXRS646TBGZ-EP	-55°C to +105°C	32-Ball Ceramic BGA (6.85mm x 6.85mm x 3.8mm)	Tray, 20	BG-32-3
ADXRS646TBGZ-EP-RL	-55°C to +105°C	32-Ball Ceramic BGA (6.85mm x 6.85mm x 3.8mm)	Reel, 500	BG-32-3

¹ Z = RoHS Compliant Part.