

Dual Output Differential Speed and Direction Sensor IC

FEATURES AND BENEFITS

- Two independent digital outputs representing the sensed target's mechanical profile
- Optional output with high-resolution position and direction detection information
- Air gap independent switch points
- Integrated back-biasing magnetic circuit
- Immunity to external magnetic interference
- Wide operating voltage range
- Single chip IC for high reliability
- Robust test coverage and reliability using Scan and IDDQ test methodologies
- Optional Double-Bandwidth configuration

PACKAGE: 4-PIN SIP (SUFFIX SG)

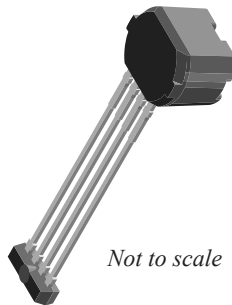

DESCRIPTION

The ATS605LSG provides a single IC solution to rotational position sensing applications with a ferrous gear target. The SG package incorporates a rare-earth pellet for ease of manufacturing, consistent performance over temperature, and enhanced reliability.

Three Hall elements are incorporated to create two independent differential channels. These channels are processed by the IC which contains a sophisticated digital circuit designed to eliminate the detrimental effects of magnet and system offsets. Hall differential signals are used to produce a highly accurate speed output and, if desired, provide information on the direction of rotation.

Advanced calibration techniques are used to optimize signal offset and amplitude. This calibration, combined with the digital tracking of the signal, results in accurate switch points over air gap, speed, and temperature. The open-drain outputs provide voltage output signals which mirror the sensed target's shape, with a phase separation between the two channels proportionate to the size of the target teeth versus the Hall element spacing. This sensor IC system is optimized for a variety of applications requiring dual phase gear speed and position signal information or simultaneous high-resolution gear speed and direction information.

The ATS605 is offered in a lead (Pb) free 4-pin SIP package with an integrated back-biasing magnet with a 100% matte-tin-plated leadframe.

Functional Block Diagram

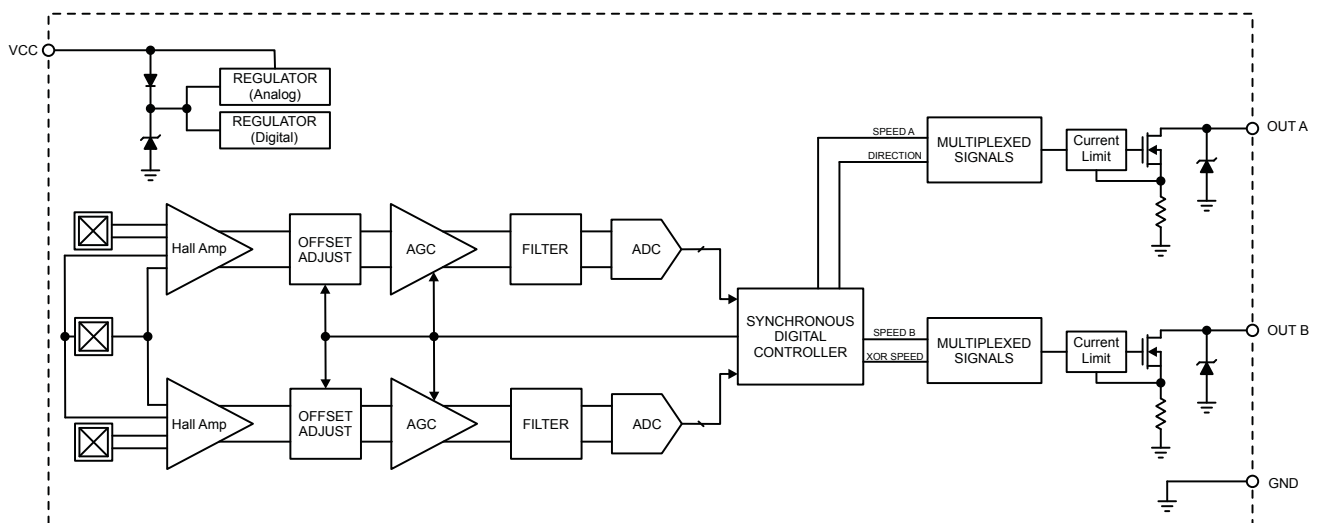

SELECTION GUIDE

Part Number	Output Configuration	Operational Frequency (kHz)	Operating Ambient Temperature Range T_A (°C)	Packing*
ATS605LSGTN-S-T	Speed (OUTA); Speed (OUTB)	20	-40 to 150	800 pieces per 13-in. reel
ATS605LSGTN-S-H-T	Speed (OUTA); Speed (OUTB)	40		
ATS605LSGTN-F-T	Direction (OUTA); XOR Speed (OUTB)	20		
ATS605LSGTN-F-H-T	Direction (OUTA); XOR Speed (OUTB)	40		
ATS605LSGTN-R-T	Inverse Direction (OUTA); XOR Speed (OUTB)	20		
ATS605LSGTN-R-H-T	Inverse Direction (OUTA); XOR Speed (OUTB)	40		



* Contact Allegro™ for additional packing options.

ABSOLUTE MAXIMUM RATINGS

Characteristic	Symbol	Notes	Rating	Unit
Supply Voltage	V_{CC}	Refer to Power Derating section	28	V
Reverse Supply Voltage	V_{RCC}		-18	V
Reverse Supply Current	I_{RCC}		-50	mA
Reverse Output Voltage	V_{ROUT}		-0.5	V
Forward Output Voltage	V_{OUT}		28	V
Output Sink Current	$I_{OUTSINK}$	Internal current limiting is intended to protect the device from output short circuits, but is not intended for continuous operation.	25	mA
Operating Ambient Temperature	T_A	L temperature range	-40 to 150	°C
Maximum Junction Temperature	$T_{J(max)}$		165	°C
Storage Temperature	T_{stg}		-65 to 170	°C

Pinout Diagram

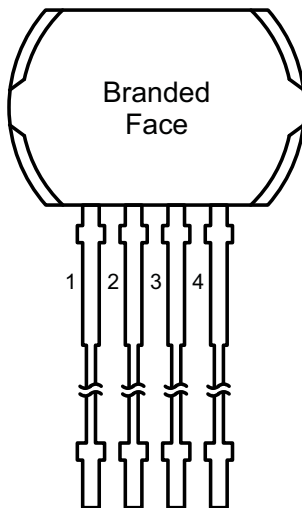

Terminal List Table

Number	Name	Description
1	VCC	Supply voltage
2	OUTB	Option [-S]: Speed (OUTB) Option [-F]: XOR Speed Option [-R]: XOR Speed
3	OUTA	Option [-S]: Speed (OUTA) Option [-F]: Default Direction Option [-R]: Inverse Direction
4	GND	Ground

OPERATING CHARACTERISTICS: Over operating voltage and temperature range, unless otherwise noted

Characteristic	Symbol	Test Conditions	Min.	Typ. [1]	Max.	Unit
ELECTRICAL CHARACTERISTICS						
Supply Voltage	V_{CC}	Operating, $T_J < T_{J(max)}$	4.0	–	24	V
Reverse Supply Voltage	V_{RCC}		–18	–	–	V
Under Voltage Lockout	$V_{CC(UV)}$	V_{CC} from 0 → 5 V or 5 → 0 V	–	–	3.95	V
Reverse Supply Current	I_{RCC}	$V_{CC} = -18$ V	–	–	–10	mA
Supply Zener Clamp Voltage	$V_{Zsupply}$	$I_{CC} = I_{CC(max)} + 3$ mA, $T_A = 25^\circ\text{C}$	28	–	–	V
Supply Current	I_{CC}	Output OFF ($V_{OUT} = \text{High}$)	–	8.5	13	mA
		Output ON ($V_{OUT} = \text{Low}$)	–	8.5	13	mA
POWER-ON STATE CHARACTERISTICS						
Power-On State	POS	V_{OUTA} , V_{OUTB} , as connected in Figure 7	–	High	–	
Power On Time [2][3]	t_{PO}	$f_{OP} < 200$ Hz	–	–	2	ms
OUTPUT STAGE FOR EACH OUTPUT PIN						
Low Output Voltage	$V_{OUT(SAT)}$	$I_{OUT} = 10$ mA, Output = ON	–	165	350	mV
Output Zener Clamp Voltage	$V_{Zoutput}$	$I_{OUT} = 3$ mA, $T_A = 25^\circ\text{C}$	28	–	–	V
Output Current Limit	$I_{OUT(LIM)}$	Output = ON ($V_{OUT} = \text{Low}$), measured with $R_{PULLUP} = 0 \Omega$, $T_J < T_{J(MAX)}$	30	55	85	mA
Output Leakage Current	$I_{OUT(OFF)}$	Output = OFF, $V_{OUT} = 24$ V	–	–	10	μA
Output Rise Time	t_r	10% - 90%, $V_{PU} = 12$ V, $R_{PULLUP} = 1$ k Ω , $C_L = 4.7$ nF	–	10	–	μs
Output Fall Time	t_f	90% - 10%, $V_{PU} = 12$ V, $R_{PULLUP} = 1$ k Ω , $C_L = 4.7$ nF	–	0.6	–	μs
DAC CHARACTERISTICS						
Allowable User-Induced Magnetic Offset [4][5]	$B_{DIFFEXT}$	User induced differential offset	–60	–	60	G
SWITCHPOINT CHARACTERISTICS						
Minimum Operational Frequency	f_{OPmin}	Allegro reference target	0	–	–	kHz
Maximum Operational Frequency	f_{OPmax}	Allegro reference target	–	20	–	kHz
		Allegro reference target, double-bandwidth option, suffix “-H”	–	40	–	kHz
Analog Signal Bandwidth	f_{-3dB}	Cutoff frequency for low-pass filter	–	20	–	kHz
		Cutoff frequency for low-pass filter, double-bandwidth option	–	40	–	kHz
Operate Point	B_{OP}	% of $V_{PROC(PKPK)}$, Output OFF to ON	–	70	–	%
Release Point	B_{RP}	% of $V_{PROC(PKPK)}$, Output ON to OFF	–	30	–	%
Lockout Enable	V_{LOE}	$V_{PROC(PKPK)} < V_{LOE} = \text{Output Switching Disabled}$	–	250	–	mV
Lockout Release	V_{LOR}	$V_{PROC(PKPK)} > V_{LOE} = \text{Output Switching Enabled}$	–	350	–	mV

Continued on the next page...

[1] Typical data is at $V_{CC} = 12$ V and $T_A = +25^\circ\text{C}$. Performance may vary for individual units, within the specified maximum and minimum limits.

[2] Power-On Time is the time required to complete the internal automatic offset adjust; the registers are then ready for peak acquisition.

[3] High speed power-on compliant, however several missing output transitions are possible.

[4] 1 G (gauss) = 0.1 mT (millitesla).

[5] The device compensates for magnetic and installation offsets. Offsets greater than specification in gauss may cause inaccuracies in the output.

OPERATING CHARACTERISTICS (continued): Valid throughout full operating and temperature ranges; using Reference Target 60-0; unless otherwise specified

Characteristic	Symbol	Test Conditions	Min.	Typ. [7]	Max.	Unit
CALIBRATION						
First Output Edge	–	$f_{OP} < 600 \text{ Hz}$, $V_{CC} > V_{CC(MIN)}$	–	1	–	tooth
Initial Calibration [8]	CAL _I		–	3	8	edge
OPERATING CHARACTERISTICS (with Allegro 60-0 reference target)						
Operational Air Gap Range [9]	AG		0.75	–	3	mm
Direction Output Delay	t_d	Delay between first XOR SPEED output transition and reported direction change	–	400	–	ns
Maximum Sudden Air Gap Change / Signal Reduction [10]	ΔB_{IN}	Differential magnetic signal reduction due to instantaneous air gap change; symmetrical signal reduction, $f_{OP} < 500 \text{ Hz}$, $V_{PROC(PKPK)} > V_{LOE}$ after sudden air gap change	–	40	–	% pk-pk
Duty Cycle Variation	ΔD	Valid for SPEED(OUTA) and SPEED(OUTB)	40	50	60	%
Minimum Operating Signal [11]	B_{IN}	$f_{OP} < 10 \text{ kHz}$	–	30	–	G
		$10 \text{ kHz} \leq f_{OP} \leq 20 \text{ kHz}$	–	60	–	G
		$f_{OP} < 10 \text{ kHz}$ Double-bandwidth option, suffix "-H"	–	30	–	G
		$10 \text{ kHz} \leq f_{OP} \leq 20 \text{ kHz}$ Double-bandwidth option, suffix "-H"	–	45	–	G
		$20 \text{ kHz} < f_{OP}$ Double-bandwidth option, suffix "-H"	–	60	–	G

[7] Typical data is at $V_{CC} = 12 \text{ V}$ and $T_A = +25^\circ\text{C}$. Performance may vary for individual units, within the specified maximum and minimum limits.

[8] Possible reduced edge accuracy, ΔD not guaranteed. Edges are sensed target mechanical edges (see Definitions of Terms for Switch Points).

[9] Operating air gap is dependent on the available magnetic field. The available field is target geometry and material dependent and should be independently characterized.

[10] Maximum single outward sudden allowable air gap change is in outward direction (increase in air gap).

[11] Output switching (no missed edges). Minimum operating signal, for either operating frequency range, is the differential magnetic field.

DEFINITIONS OF TERMS FOR SWITCH POINTS

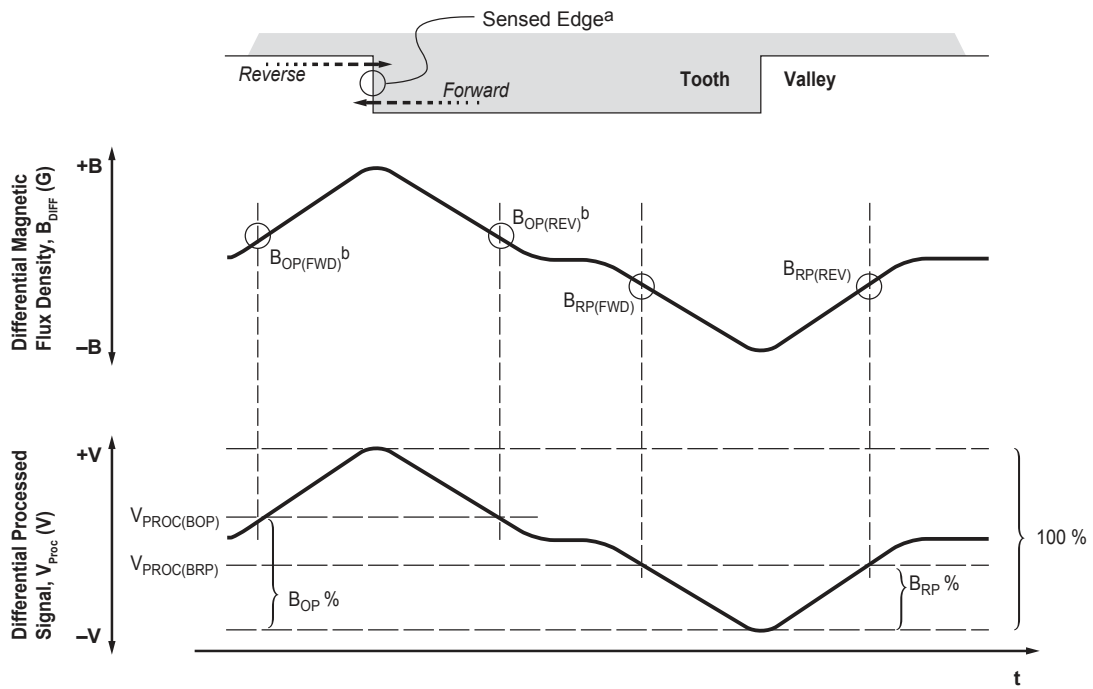

Figure 1: (a) Sensed Edge: leading (rising) mechanical edge in forward rotation, trailing (falling) mechanical edge in reverse rotation; (b) B_{OP(FWD)} triggers the output transition during forward rotation, and B_{OP(REV)} triggers the output transition during reverse rotation.

REFERENCE TARGET CHARACTERISTICS 60-0 (60 Tooth Target)

Characteristics	Symbol	Test Conditions	Typ.	Unit	Symbol Key
Outside Diameter	D_o	Outside Diameter of Target	120	mm	
Face Width	F	Breadth of tooth, with respect to sensor IC	6	mm	
Circular Tooth Length	t	Length of tooth, with respect to sensor IC; measured at D_o	3	deg	
Circular Valley Width	t_v	Length of valley, with respect to sensor IC; measured at D_o	3	deg	
Tooth Whole Depth	h_t		3	mm	
Material		Low Carbon Steel	-	-	

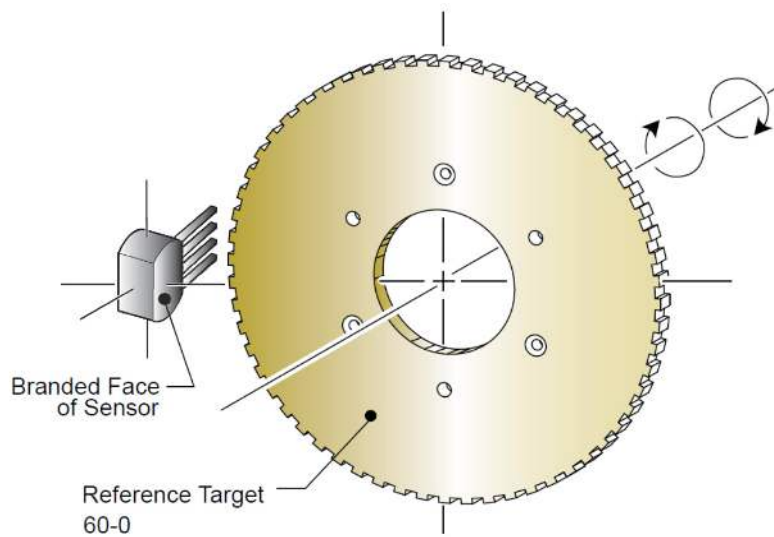

Figure 2: Example of Allegro Reference Gear

FUNCTIONAL DESCRIPTION

Sensing Technology

The ATS605 module contains a single-chip, dual differential Hall-effect sensor IC, a rare earth pellet, and a flat ferrous pole piece (concentrator). As shown in Figure 4, the Hall IC supports three Hall elements, which sense the magnetic profile of the ferrous gear target simultaneously, but at different points (each channel spaced at a 1.75 mm pitch), generating two differential internal analog voltages, V_{PROC} , that is processed for precise switching of the digital output signals.

The Hall IC is self-calibrating and also possesses a temperature compensated amplifier and offset cancellation circuitry. Its voltage regulator provides supply noise rejection throughout the operating voltage range. Changes in temperature do not greatly affect this device due to the stable amplifier design and the offset rejection circuitry. The Hall transducers and signal processing electronics are integrated on the same silicon substrate, using a proprietary BiCMOS process.

Target Profiling During Operation

An operating device is capable of providing digital information that is representative of the mechanical features of a rotating gear. The waveform diagram in Figure 4 presents the automatic translation of the mechanical profile, through the magnetic profile that it induces, to the digital output signal of the ATS605. No additional optimization is needed and minimal processing circuitry is required. This ease of use reduces design time and incremental assembly costs for most applications.

Operating Modes:

Calibration

Once the power-on time has elapsed, the sensor IC internally detects the magnetic profile of the target. The output becomes active at the first detected switchpoint.

The gain of the sensor IC is adjusted during the Calibration period, normalizing the internal signal amplitude for the air gap range of the device. This Automatic Gain Control (AGC) feature ensures that operational characteristics are isolated from the effects of installation air gap variation.

Automatic Offset Adjustment (AOA) is circuitry that compensates for the effects of chip, magnet, and installation offsets. (For capability, see Allowable User-Induced Magnetic Offset, in the Operating Characteristics table.) This circuitry works with the AGC during calibration to help center V_{PROC} in the dynamic range to allow for DAC acquisition of signal peaks.

Calibration also allows for the peak detecting DACs to properly acquire the magnetic signal, so that Running Mode switch points can be accurately computed.

Running Mode

After calibration is complete, direction information is available. This information is communicated through the available output option.

Peak-tracking DAC algorithms allow tracking of signal drift over temperature changes, as well as tracking of target variations, such as tooth-to-tooth variation and effective runout. The sensor's dynamic monitoring of these signal peaks is updated on each tooth and valley edge.

Automatic Offset Adjust remains active, allowing the IC to compensate for offsets induced by temperature variations over time.

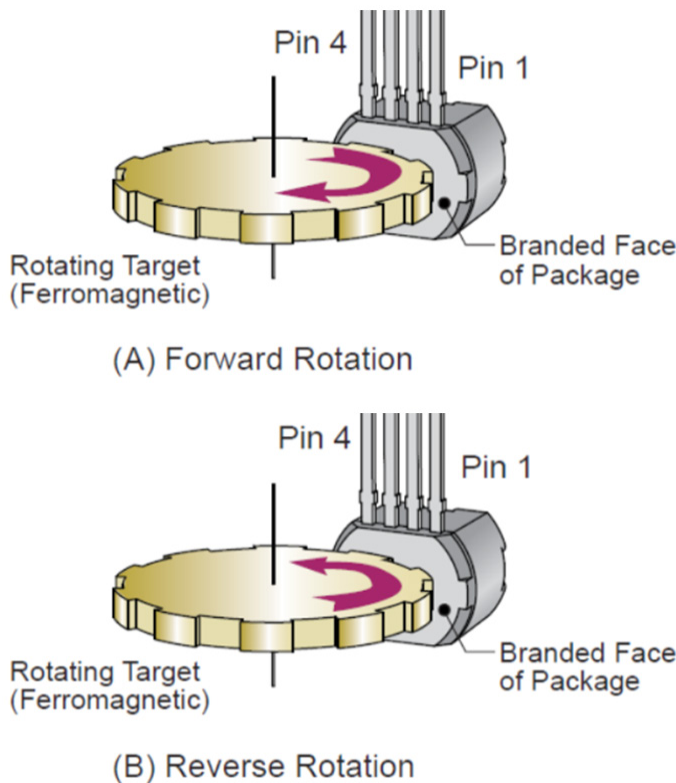

Figure 3: Target Rotation for Default Sensing Configuration. (A) Pin 4 to pin 1 is forward, and (B) pin 1 to pin 4 is reverse.

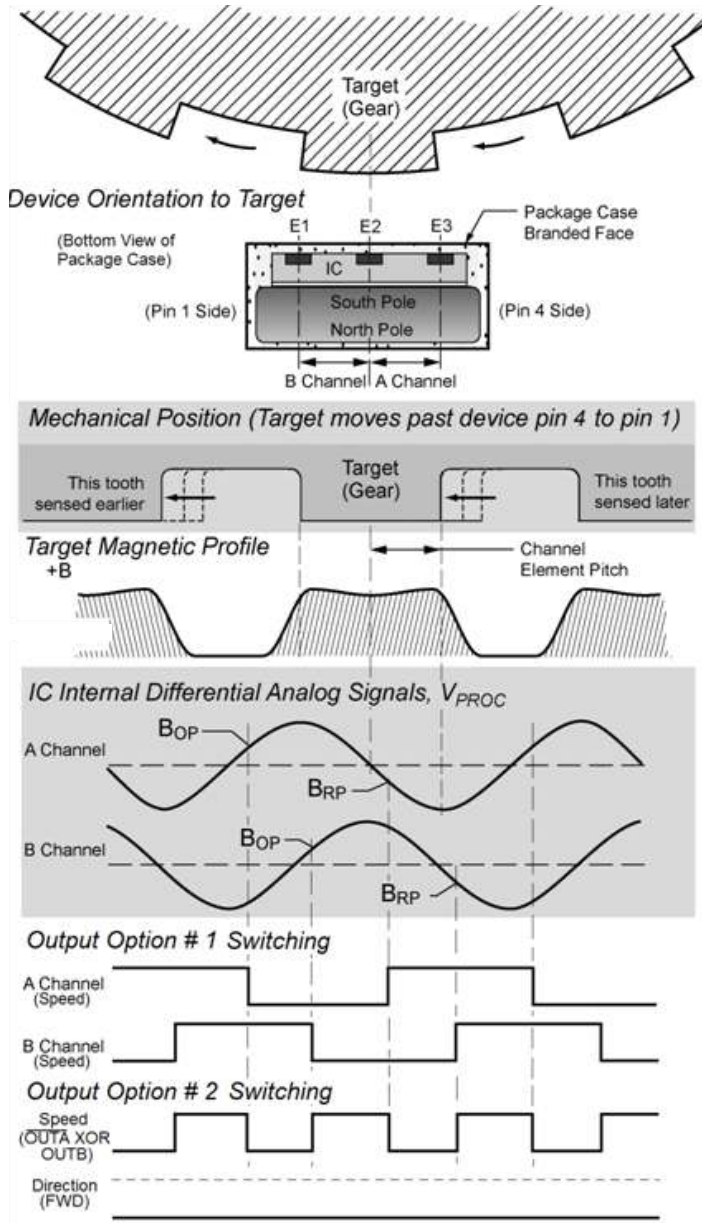

Figure 4: The magnetic profile reflects the geometry of the target, allowing the ATS605 to present an accurate digital output response. Please see Figure 5 for more detailed output switching.

Output

The device provides three outputs (DIRECTION, XOR SPEED, and SPEED), available in two combinations: *Option #1 (-S)* is SPEED (Ch. A) and SPEED (Ch. B), and *Option #2 (-F)* is XOR SPEED and DIRECTION. DIRECTION provides the target rotation direction relative to the device. XOR SPEED provides an XOR'd output of the two speed channels (Ch. A and Ch. B), which results in double the speed data rate without requiring changes to be made to the controller. SPEED will be updated before DIRECTION and is updated at every transition of both Channel A and Channel B allowing the use of up-down counters without the loss of pulses.

Output Polarity

In Figure 4, the top panel, labeled *Mechanical Position*, represents the mechanical features of the target gear and orientation to the device. The bottom panel, labeled *Output Option #1*, the -S variant, displays the square waveforms corresponding to the digital SPEED output signals for channels A and B for a rotating gear in the forward rotation direction (gear tooth passing from the pin 4 side to the pin 1 side, Figure 3). The end result is the sensor output switching from high state to low state as the leading edge of a tooth (a rising mechanical edge, as detected by the sensor) passes the sensor face. If the direction of rotation is reversed so that the gear rotates from the pin 1 side to the pin 4 side (Figure 3), then the output polarity inverts (i.e., the output signal goes high when a rising edge is detected, and a tooth is the nearest feature to the sensor).

The *Output Option #2* panel refers to the -F variant, for which DIRECTION polarity is defined as ON (low) when the target crosses the sensor face in the forward direction (from the pin 4 side to the pin 1 side), and OFF (high) for the reverse direction (from the pin 1 side to the pin 4 side). There is an option, ATS605LSG-TN-R-T, that inverts this DIRECTION output signal polarity (SPEED output polarity is unaffected and remains as defined above). XOR SPEED polarity is defined as SPEED A XOR SPEED B.

Table 1: Output Pin Descriptions

Option	Pin 2 / OUTB	Pin 3 / OUTA
Option 1 (“-S”)	SPEED B	SPEED A
Option 2 (“-F”)	XOR SPEED	DIRECTION
Option 2 (“-R”)	XOR SPEED	Inverted DIRECTION

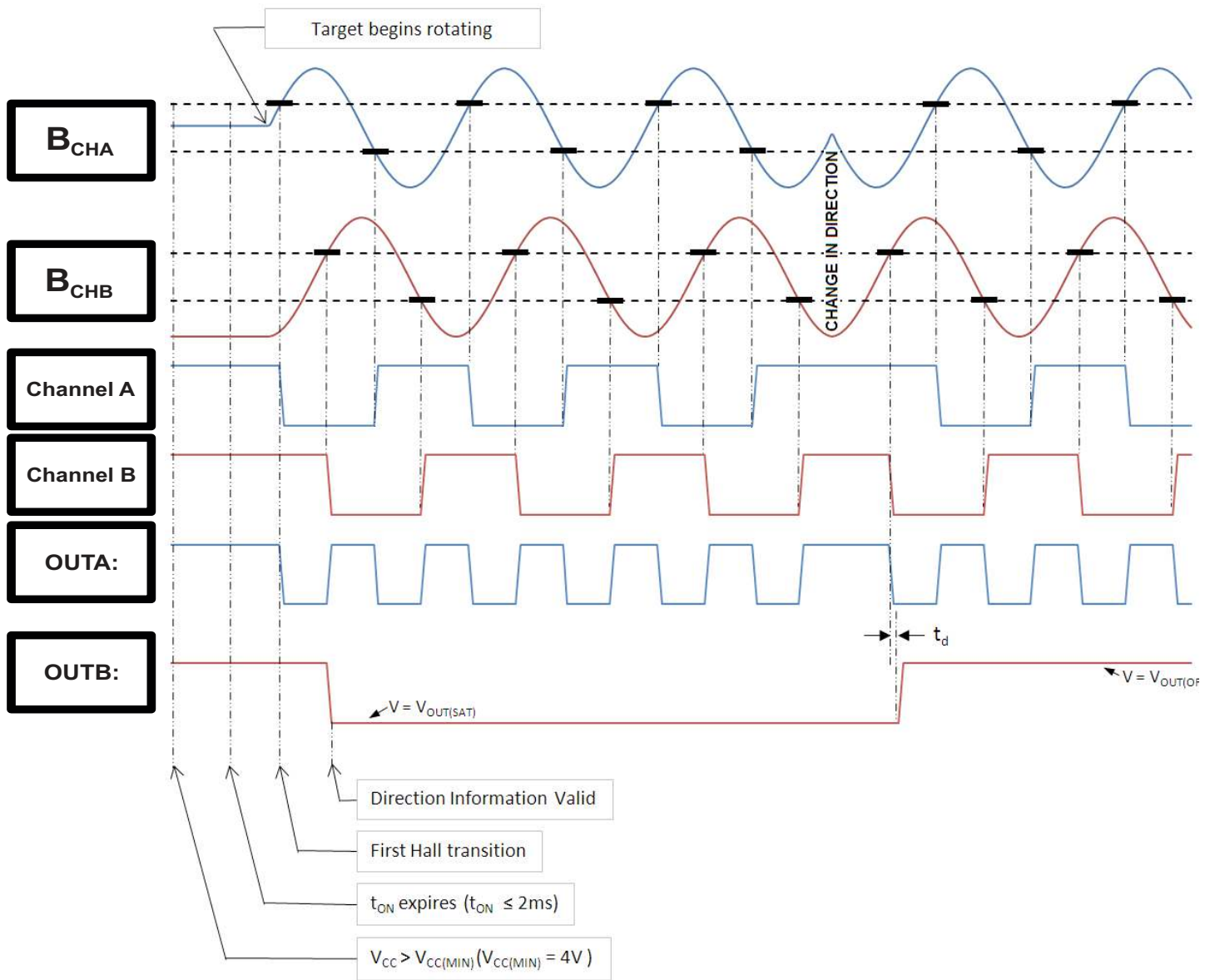

Figure 5: Direction change, first showing the default forward rotation output polarity and then for the same output configuration, the reverse direction polarity is shown (Pin 4 to Pin 1 is FWD).

DEVICE FEATURES

Undervoltage Lockout

When the supply voltage falls below the undervoltage lockout voltage, UVLO, the device enters Reset, where the output state returns to the Power-On State (POS) until sufficient V_{CC} is supplied. I_{CC} levels may not meet datasheet limits when $V_{CC} < V_{CC}(\min)$. This lockout feature prevents false signals, caused by undervoltage conditions, from propagating to the output of the sensor.

Power Supply Protection

The device contains an on-chip regulator and can operate over a wide V_{CC} range. For devices that need to operate from an unregulated power supply, transient protection must be added externally. For applications using a regulated line, EMI/RFI protection may still be required. Contact Allegro MicroSystems for information on the circuitry needed for compliance with various EMC specifications. Refer to Figure 7 for an example of a basic application circuit.

Automatic Gain Control (AGC)

This feature allows the device to operate with an optimal internal electrical signal, regardless of the air gap (within the AG specification). At power-on, the device determines the peak-to-peak amplitude of the signal generated by the target. The gain of the sensor is then automatically adjusted. Figure 6 illustrates the effect of this feature.

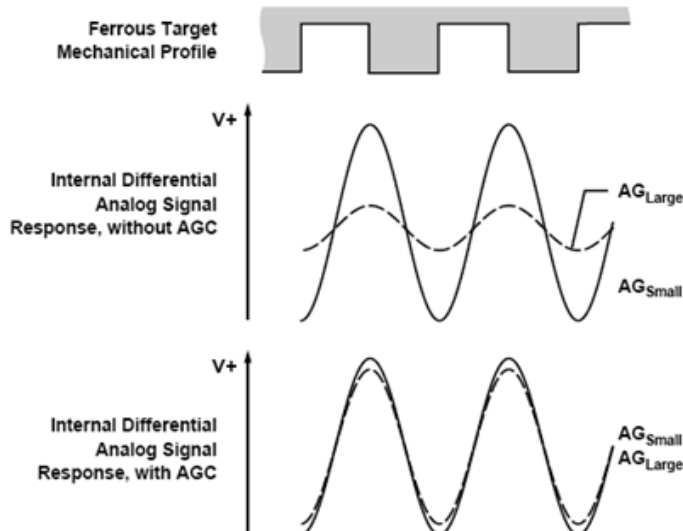

Figure 6: Automatic Gain Control (AGC). The AGC function corrects for variances in the air gap. Differences in the air gap cause differences in the magnetic field at the device, but AGC prevents that from affecting device performance, as shown in the lower panel.

Automatic Offset Adjust (AOA)

The AOA circuitry automatically compensates for the effects of chip, magnet, and installation offsets. (For capability, see Allowable User-Induced Magnetic Offset, in the Operating Characteristics table.) This circuitry is continuously active, including both during power-on mode and running mode, compensating for any offset drift (within Allowable User-Induced Magnetic Offset). Continuous operation also allows it to compensate for offsets induced by temperature variations over time.

Lockout

The ATS605 has a lockout feature to prevent switching on small signals that are characteristic of vibration signals. The internal logic of the chip will consider small signal amplitudes below a certain level to be vibration. The output will then be held to the state prior to lockout until the amplitude of the signal returns to normal operational levels. Lockout is independent between speed channels for the SPEED and SPEED output configuration, allowing one channel to continue switching without the other. The alternative XOR SPEED and DIRECTION configuration requires both channels to exceed the lockout release value before enabling these output signals.

Assembly Description

The ATS605 is integrally molded into a plastic body that has been optimized for size, ease of assembly, and manufacturability. High operating temperature materials are used in all aspects of construction.

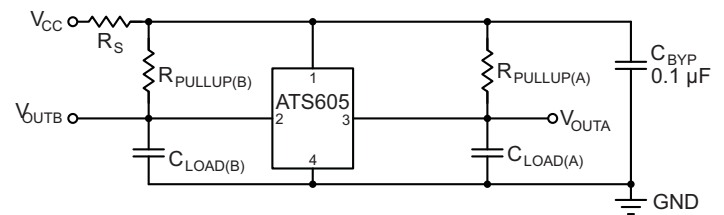

Figure 7: Typical Application Circuit

Start Mode Hysteresis

This feature helps to ensure optimal self-calibration by rejecting electrical noise and low-amplitude target vibration during initialization. This prevents AGC from calibrating the IC on such spurious signals. Calibration can be performed using the actual target features.

A typical scenario is shown in Figure 8. The Start Mode Hysteresis, PO_{HYS} , is a minimum level of the peak-to-peak amplitude of the internal analog electrical signal, V_{PROC} , that must be exceeded before the ATS605 starts to compute switch points.

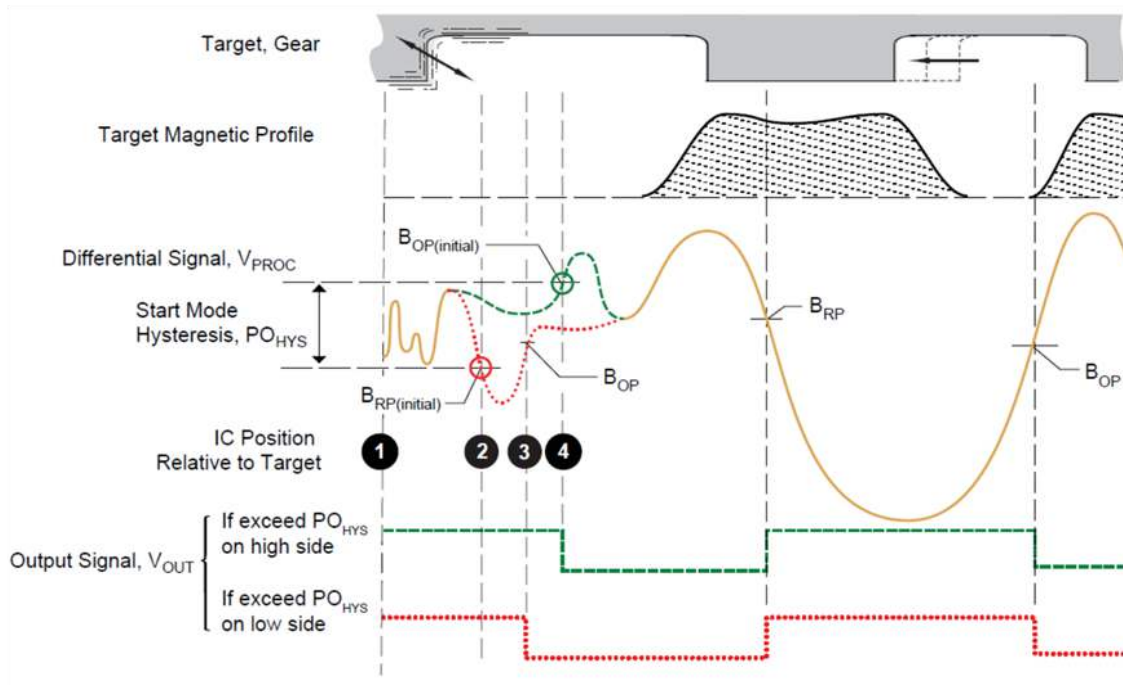

Figure 8: Operation of Start Mode Hysteresis

- At power-on (position 1), the ATS605 begins sampling V_{PROC} .
- At the point where the Start Mode Hysteresis, PO_{HYS} , is exceeded, the device establishes an initial switching threshold, by using the Continuous Update algorithm. If V_{PROC} is falling through the limit on the low side (position 2), the switchpoint is B_{RP} , and if V_{PROC} is rising through the limit on the high side (position 4), it is B_{OP} . After this point, Start Mode Hysteresis is no longer a consideration. Note that a valid V_{PROC} value exceeding the Start Mode Hysteresis can be generated either by a legitimate target feature or by excessive vibration.
- In either case, because the switchpoint is immediately passed as soon as it is established, the ATS605 enables switching:
 - If on the low side, at B_{RP} (position 2) the output would switch from low to high. However, because output is already high, no output switching occurs.
 - At the next switchpoint, where B_{OP} is passed (position 3), the output switches from high to low.
 - If on the high side, at B_{OP} (position 4) the output switches from high to low.

As this example demonstrates, initial output switching occurs with the same polarity, regardless of whether the Start Mode Hysteresis is exceeded on the high side or on the low side

CHARACTERISTIC PERFORMANCE

Average Supply Current (On) versus Ambient Temperature

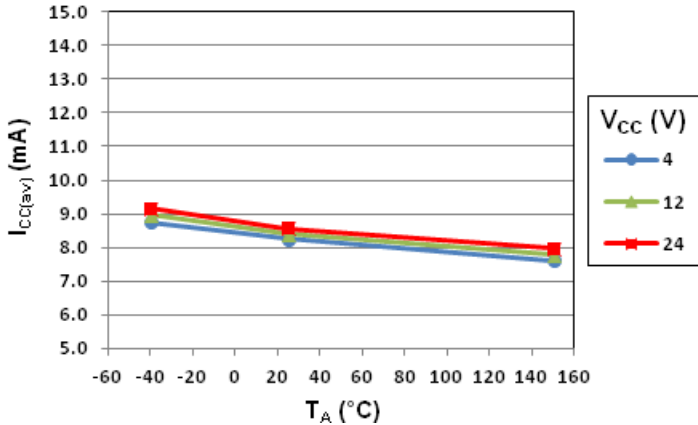

Average Supply Current (On) versus Supply Voltage

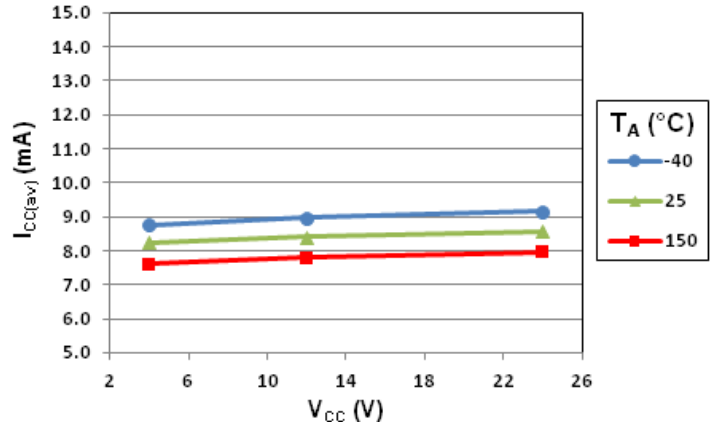

Average Supply Current (Off) versus Ambient Temperature

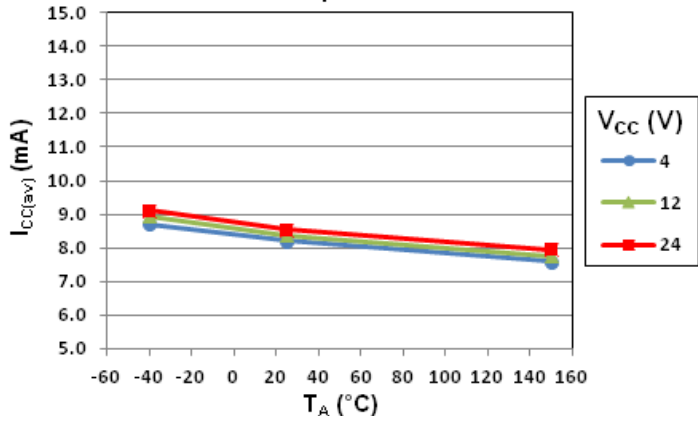

Average Supply Current (Off) versus Supply Voltage

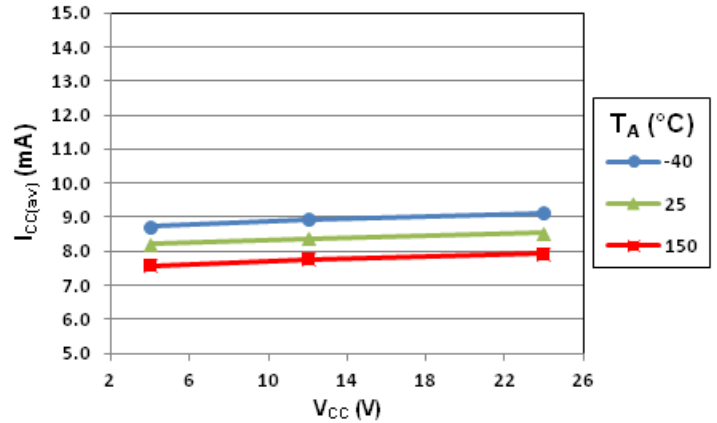

Average Output Saturation Voltage versus Ambient Temperature

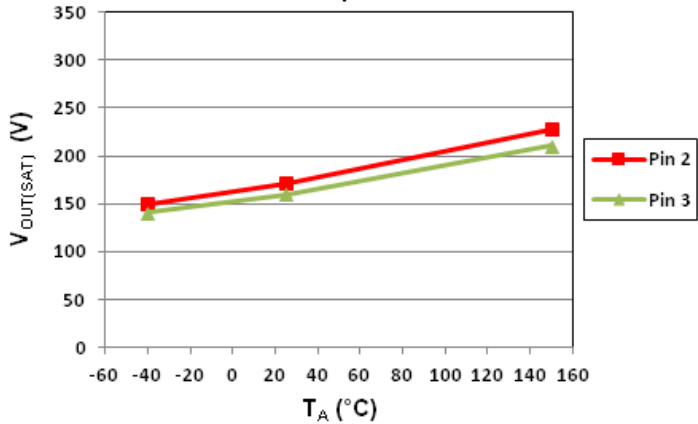

Average Rise and Fall Time versus Ambient Temperature

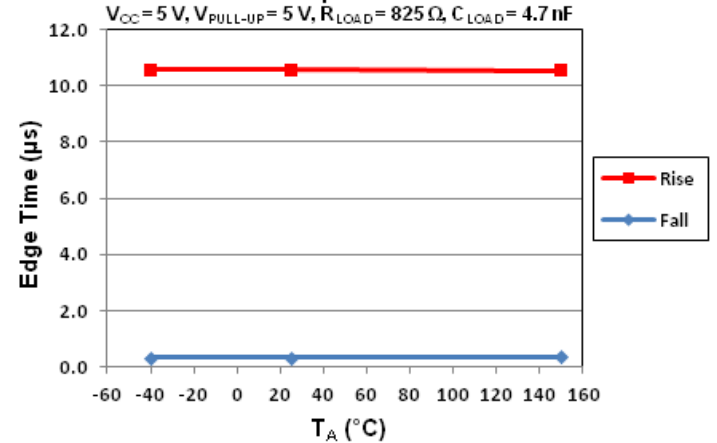

CHARACTERISTIC PERFORMANCE (continued)

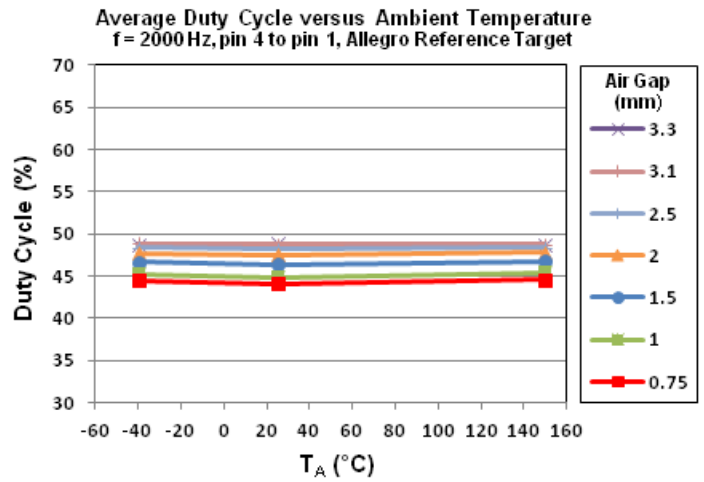
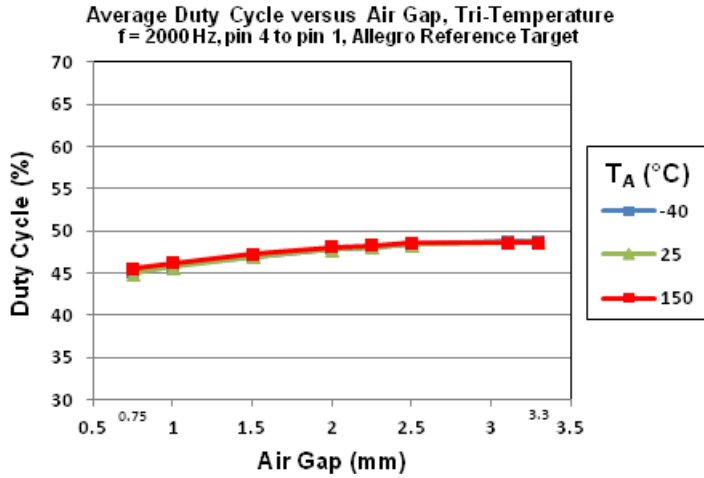

THERMAL CHARACTERISTICS

Characteristic	Symbol	Test Conditions	Value	Unit
Package Thermal Resistance	$R_{\theta JA}$	Minimum-K PCB, single-layer, single-sided, with copper limited to solder pads)	126	$^{\circ}\text{C}/\text{W}$
		Low-K PCB, single-layer, single-sided with copper limited to solder pads and 3.57 in. ² (23.03 cm ²) of copper area each side	84	$^{\circ}\text{C}/\text{W}$

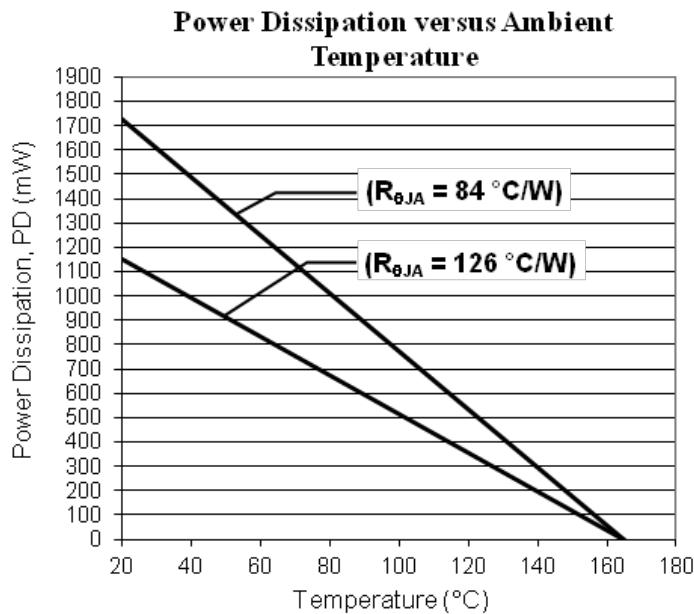
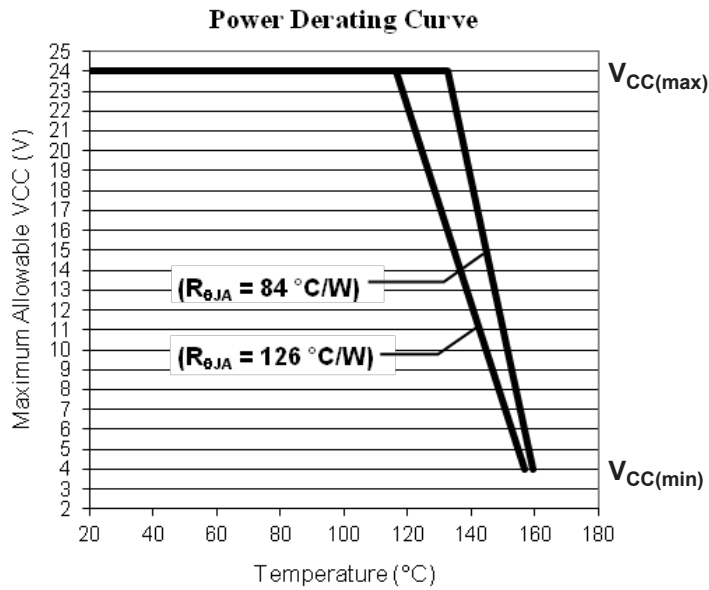

POWER DERATING

The device must be operated below the maximum junction temperature of the device, $T_{J(max)}$. Under certain combinations of peak conditions, reliable operation may require derating supplied power or improving the heat dissipation properties of the application. This section presents a procedure for correlating factors affecting operating T_J . (Thermal data is also available on the Allegro MicroSystems website.)

The Package Thermal Resistance, $R_{\theta JA}$, is a figure of merit summarizing the ability of the application and the device to dissipate heat from the junction (die), through all paths to the ambient air. Its primary component is the Effective Thermal Conductivity, K , of the printed circuit board, including adjacent devices and traces. Radiation from the die through the device case, $R_{\theta JC}$, is relatively small component of $R_{\theta JA}$. Ambient air temperature, T_A , and air motion are significant external factors, damped by overmolding.

The effect of varying power levels (Power Dissipation, P_D), can be estimated. The following formulas represent the fundamental relationships used to estimate T_J , at P_D .

$$P_D = V_{IN} \times I_{IN} \tag{1}$$

$$\Delta T = P_D \times R_{\theta JA} \tag{2}$$

$$T_J = T_A + \Delta T \tag{3}$$

For example, given common conditions such as:

$T_A = 25^\circ C$, $V_{CC} = 12 V$, $R_{\theta JA} = 126^\circ C/W$, and

$I_{CC} = 8.5 mA$, then:

$$P_D = V_{CC} \times I_{CC} = 12 V \times 8.5 mA = 102 mW$$

$$\Delta T = P_D \times R_{\theta JA} = 102 mW \times 126^\circ C/W = 12.9^\circ C$$

$$T_J = T_A + \Delta T = 25^\circ C + 12.9^\circ C = 37.9^\circ C$$

A worst-case estimate, $P_{D(max)}$, represents the maximum allowable power level ($V_{CC(max)}$, $I_{CC(max)}$), without exceeding $T_{J(max)}$, at a selected $R_{\theta JA}$ and T_A .

Example: Reliability for V_{CC} at $T_A = 150^\circ C$, package SG, using single-layer PCB.

Observe the worst-case ratings for the device, specifically:

$R_{\theta JA} = 126^\circ C/W$, $T_{J(max)} = 165^\circ C$, $V_{CC(max)} = 24 V$, and $I_{CC} = 13 mA$.

Calculate the maximum allowable power level, $P_{D(max)}$. First, invert equation 3:

$$\Delta T_{max} = T_{J(max)} - T_A = 165^\circ C - 150^\circ C = 15^\circ C$$

This provides the allowable increase to T_J resulting from internal power dissipation. Then, invert equation 2:

$$P_{D(max)} = \Delta T_{max} \div R_{\theta JA} = 15^\circ C \div 126^\circ C/W = 119 mW$$

Finally, invert equation 1 with respect to voltage:

$$V_{CC(est)} = P_{D(max)} \div I_{CC(max)} = 119 mW \div 13 mA = 9.2 V \tag{1}$$

- (2) The result indicates that, at T_A , the application and device can dissipate adequate amounts of heat at voltages $\leq V_{CC(est)}$.

Compare $V_{CC(est)}$ to $V_{CC(max)}$. If $V_{CC(est)} \leq V_{CC(max)}$, then reliable operation between $V_{CC(est)}$ and $V_{CC(max)}$ requires enhanced $R_{\theta JA}$. If $V_{CC(est)} \geq V_{CC(max)}$, then operation between $V_{CC(est)}$ and $V_{CC(max)}$ is reliable under these conditions.

Package SG, 4-Pin SIP

For Reference Only – Not for Tooling Use

(Reference DWG-0000392)

Dimensions in millimeters. NOT TO SCALE.

Dimensions exclusive of mold flash, gate burrs, and dambar protrusions
Exact case and lead configuration at supplier discretion within limits shown

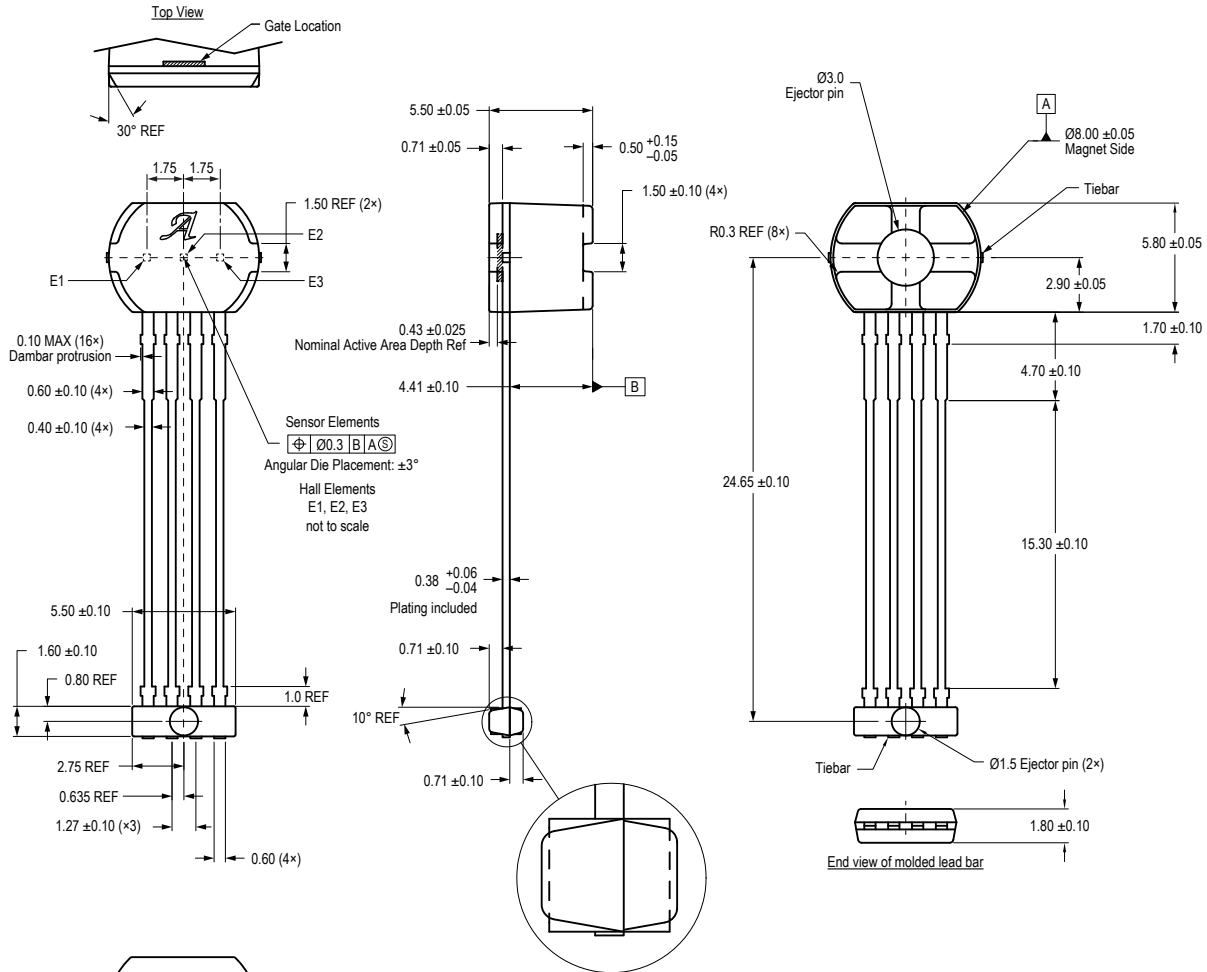

Standard Branding Reference View

Lines 2, 3, 4 = 7 characters.

Line 1: Logo A molded in
Line 2: 7-digit alpha numeric Lot Number
Line 3: Last 3 digit of Part Number.
Additional suffixes may be added to Part number as required.
Line 4: 4-digit Date Code

Center align

Branding scale and appearance at supplier discretion

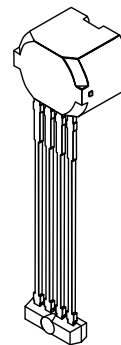

Revision History

Number	Date	Description
–	March 28, 2014	Initial release
1	December 5, 2016	Updated Functional Block Diagram (page 1) and Minimum Operating Signal (page 4)
2	June 15, 2017	Corrected typo in symbol for Output Fall Time (page 3)
3	June 20, 2018	Minor editorial updates
4	July 3, 2019	Minor editorial updates
5	July 9, 2021	Updated package drawing (page 16)

Copyright 2021, Allegro MicroSystems.

Allegro MicroSystems reserves the right to make, from time to time, such departures from the detail specifications as may be required to permit improvements in the performance, reliability, or manufacturability of its products. Before placing an order, the user is cautioned to verify that the information being relied upon is current.

Allegro's products are not to be used in any devices or systems, including but not limited to life support devices or systems, in which a failure of Allegro's product can reasonably be expected to cause bodily harm.

The information included herein is believed to be accurate and reliable. However, Allegro MicroSystems assumes no responsibility for its use; nor for any infringement of patents or other rights of third parties which may result from its use.

Copies of this document are considered uncontrolled documents.

For the latest version of this document, visit our website:

www.allegromicro.com