

PFR5151J100J11L4BULK

Aliases (F411JH151J100C)

PFR/F411, Film, Film/Foil Polypropylene, General Purpose, 150 pF, 5%, 100 VDC, 85°C, Lead Spacing = 5mm

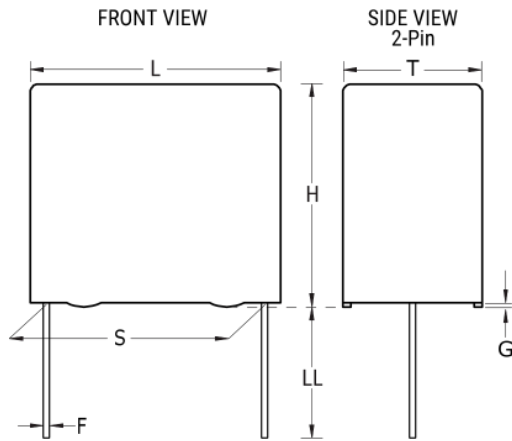

Click [here](#) for the 3D model.

Dimensions

L	7.2mm -0.5mm
H	6mm -0.5mm
T	4.5mm -0.5mm
S	5mm -0.4mm
LL	4mm +1mm
F	0.5mm +/-0.05mm
G	0.5mm NOM

Packaging Specifications

Packaging	Bulk, Bag
Packaging Quantity	1000

General Information

Series	PFR/F411
Dielectric	Film/Foil Polypropylene
Style	Radial
Features	Pulse
RoHS	Yes
Lead	Wire Leads
AEC-Q200	No
Component Weight	0.394 g
Miscellaneous	An Operating Temperature Up To +105C Is Allowed Under Certain Conditions. Please Consult KEMET For Details.

Specifications

Capacitance	150 pF
Capacitance Tolerance	5%
Voltage AC	63 VAC
Voltage DC	100 VDC
Temperature Range	-55/+100°C
Rated Temperature	85°C
Dissipation Factor	0.04% 1kHz, 0.04% 10kHz, 0.05% 100kHz
Insulation Resistance	100 GOhms
Max dV/dt	1000 V/us
Inductance	6 nH