



# American Opto Plus LED Corp.

## L314SYD

### 3mm Yellow LED Lamp

#### PACKAGE OUTLINES

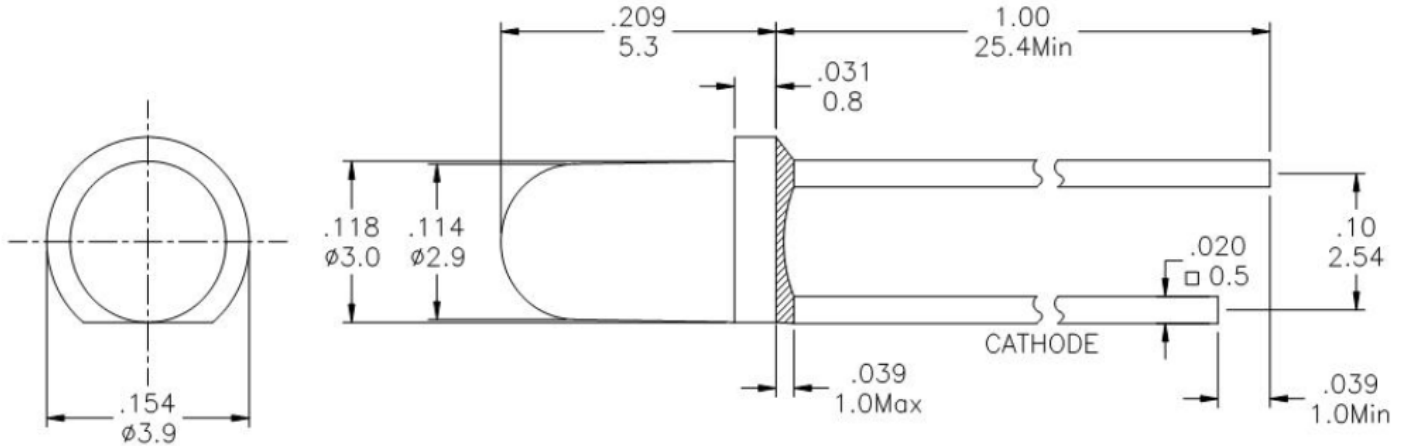

**Notes:**

1. All dimensions are in millimeters (inch).
2. Tolerances are  $\pm 0.25\text{mm}$  ( $\pm 0.01$  inch) unless otherwise noted.

Part Number	Material	Color	
		Emitted	Lens
L314SYD	AllnGaP	Yellow	Yellow Diffused



# American Opto Plus LED Corp.

## L314SYD

### 3mm Yellow LED Lamp

#### ABSOLUTE MAXIMUM RATINGS

(Ta=25°C)

Parameter	Symbol	Value	Unit
Power Dissipation	$P_D$	72	mW
Reverse Voltage	$V_R$	5	V
Forward Current	$I_F$	30	mA
Peak Forward Current (Duty=0.1, 1kHz)	$I_{FP}$	100	mA
Operating Temperature Range	$T_{OPR}$	-40~+80	°C
Storage Temperature Range	$T_{STG}$	-40~+100	°C
Lead Soldering Temperature	$T_{SOL}$	Max 260°C for 5 sec (1.6mm(0.063inch) from Body)	

#### OPTICAL-ELECTRICAL CHARACTERISTICS

(Ta=25°C)

Parameter	Symbol	Test Condition	Min	Typ	Max	Unit
Forward Voltage	$V_F$	$I_F=10\text{mA}$	--	2.0	2.4	V
Dominant Wavelength	$\lambda_D$		--	588	--	nm
Viewing Angle	$2\theta_{1/2}$		--	50	--	deg
Luminous Intensity	$I_V$	$I_F=10\text{mA}$	77	170	--	mcd
		$I_F=20\text{mA}$	110	250	--	
Reverse Current	$I_R$	$V_R=5\text{V}$	--	--	100	$\mu\text{A}$

#### Notes:

1. Forward voltage data did not include  $\pm 0.1\text{V}$  testing tolerance.
2. Luminous intensity data did not included  $\pm 15\%$  testing tolerance.



# American Opto Plus LED Corp.

## L314SYD

### 3mm Yellow LED Lamp

#### BIN COMBINATIONS

##### Luminous Intensity Rank Limits ( $I_F=10\text{mA}$ )

Code	Min	Max	Unit
19	77	130	mcd
20	130	170	
21	170	220	
22	220	290	

##### Dominant Wavelength Rank Limits ( $I_F=10\text{mA}$ )

Code	Min	Max	Unit
Y6	586.5	588	nm
Y7	588	590	
Y8	590	592	
Y9	592	594	

##### Forward Voltage Rank Limits ( $I_F=10\text{mA}$ )

Code	Min	Max	Unit
B	1.6	1.8	V
C	1.8	2.0	
D	2.0	2.2	
E	2.2	2.4	

#### Notes:

1. Luminous intensity tolerance:  $\pm 15\%$
2. Dominant wavelength tolerance:  $\pm 2\text{nm}$
3. Forward voltage tolerance:  $\pm 0.05\text{V}$
4. One delivery will include several color rank,  $V_F$  rank &  $I_v$  rank of products. The quantity-ratio of ranks is decided by AOP.



# American Opto Plus LED Corp.

## L314SYD

### 3mm Yellow LED Lamp

## OPTICAL CHARACTERISTIC CURVES

Fig 1. Forward Current vs. Forward Voltage

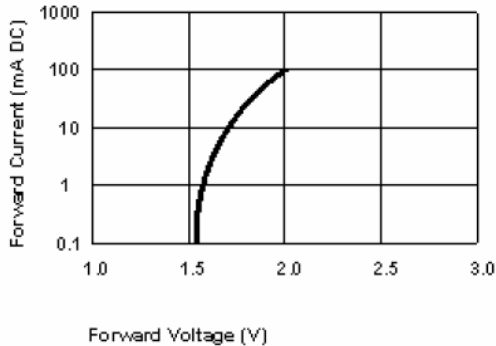

Fig 2. Relative Intensity vs. Forward Current

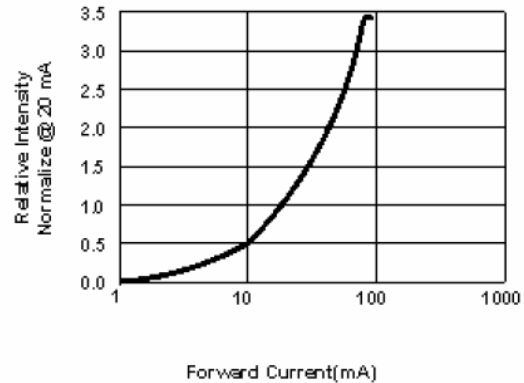

Fig 3. Forward Voltage vs. Temperature

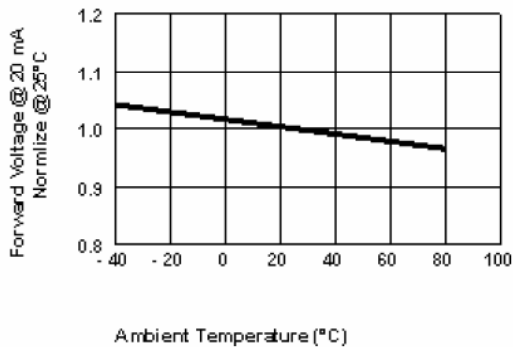

Fig 4. Relative Intensity vs. Temperature

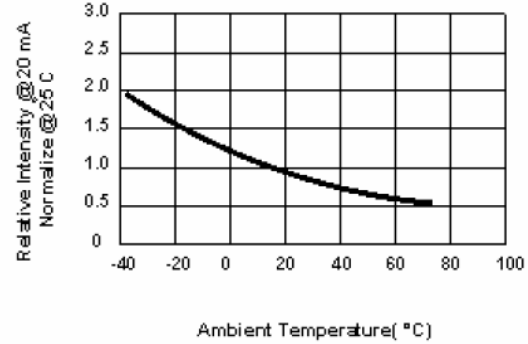

Fig5. Relative Intensity Vs. Wavelength

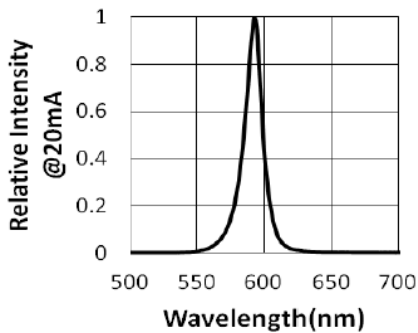
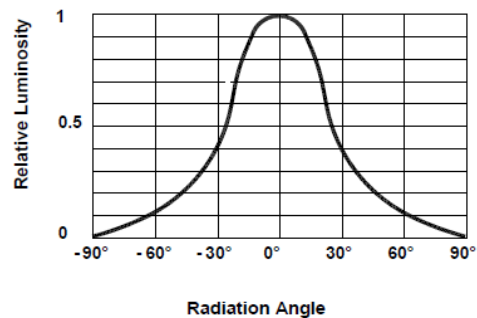

Fig6. Relative Luminous Intensity Vs. RadRadiation





# American Opto Plus LED Corp.

## L314SYD

### 3mm Yellow LED Lamp

#### PRECAUTION FOR USE

##### 1. Recommended Soldering Condition

###### 1.1 Wave Soldering

Basic spec is  $\leq 5$  sec. when  $260^{\circ}\text{C}$ . If temperature is higher, time should be shorter ( $+10^{\circ}\text{C} \rightarrow -1$  sec).

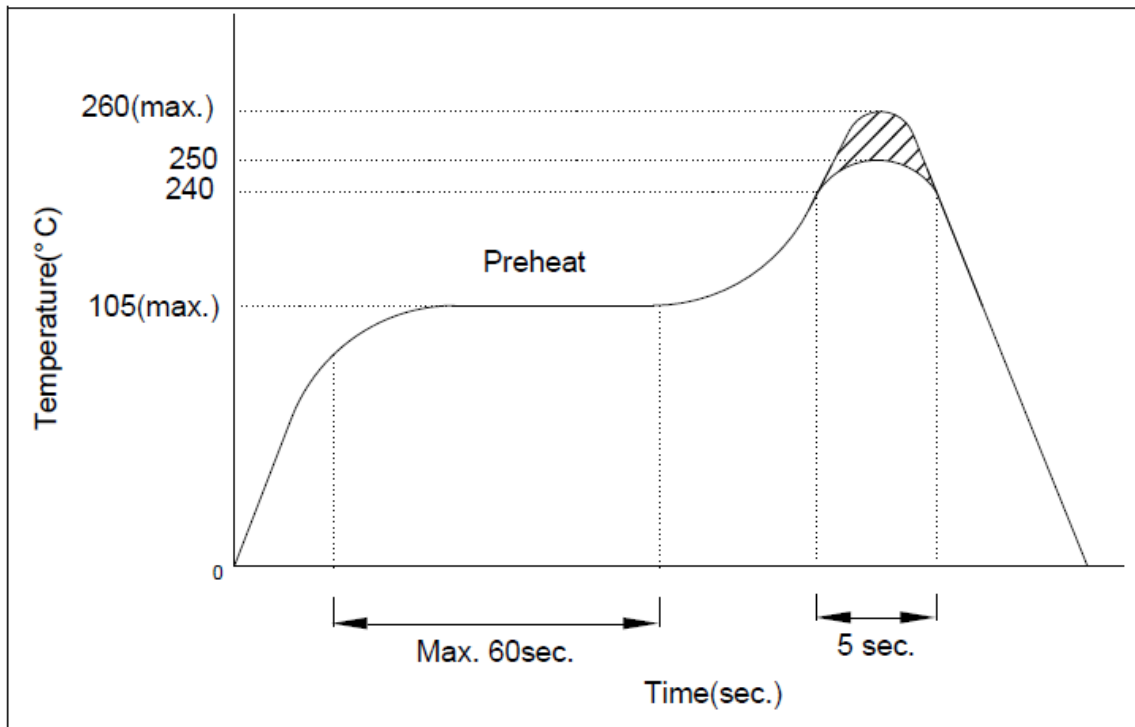

###### 1.2 Soldering Iron

Power dissipation of iron should be smaller than 15W and temperature should be controllable. Surface temperature of iron tip should be under  $230^{\circ}\text{C}$ , soldering time  $\leq 3$  sec.

##### 2. Electrostatic Discharge (ESD)

Static electricity or surge voltage will damage the LEDs.

Use of conductive wrist band or anti-electrostatic glove when handling these LEDs is recommended. All devices, equipment, work table, storage rack and machinery must be properly grounded.

In the events of manual working in process, make sure devices are well protected from ESD at all times.