

DISTINCTIVE CHARACTERISTICS

- High definition, contrast and resolution of 96RGB x 64 pixels in compact screen and minimal frame
- Range of 65,536 colors in 16 bit mode
- Operating life of 50,000 hours minimum
- Maximum use of display lens with ultra-thin frame provides full screen capacity
- Multiple units easily combine to form one screen, offering flexibility in size and layout
- Smooth operation with short stroke of 0.07" lends to tactile feedback unparalleled to touch panels
- Same outer dimensions of switch and footprint, enabling ease of replacement with current switches
- Operated by commands and data supplied via serial communications (SPI)
- Incorporates bitmap display function
- Low energy consumption
- Dust tight construction
- Snap-in standoff for easy, secure mounting and alignment; aids in prevention of dislodging during wave soldering

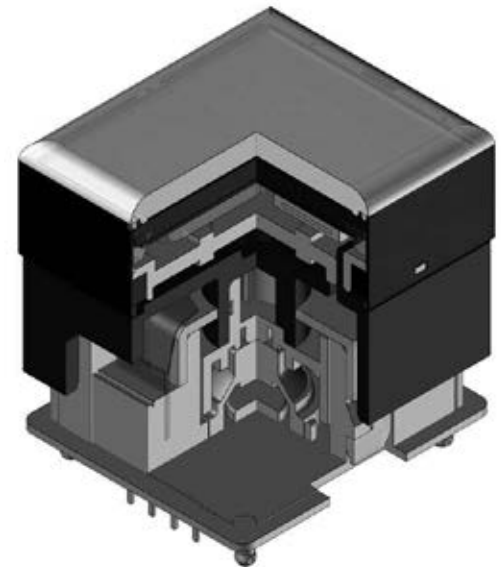

Viewing area: 21.28mm x 18.7mm (horizontal x vertical)

High reliability and long life of one million actuations minimum

Highly reliable gold plated twin contacts

Epoxy sealed straight PC terminals

Actual Size

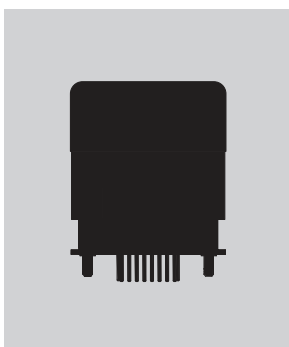



SWITCH PART NUMBER & DESCRIPTION

Part Number	Switch Description	OLED	Pixel Format
ISF15ACP4	SPST, Momentary ON Gold Contacts Straight PC Terminals	Color OLED Display Module 65,536 Colors	96RGB x 64 Pixels Horizontal x Vertical

SWITCH SPECIFICATIONS

Circuit	SPST normally open
Contact Position	Leave actuator: ① – ② OFF Push actuator: ① – ② ON
Electrical Capacity (Resistive Load)	100mA @ 12V DC (resistive circuit)
Contact Resistance	200 milliohms maximum @ 20mV 10mA
Insulation Resistance	100 megohms minimum @ 100V DC
Dielectric Strength	125V AC for 1 minute minimum
Mechanical Endurance	1,000,000 operations minimum
Electrical Endurance	1,000,000 operations minimum
Operating Force	2.0 ± 0.5 Newtons
Total Travel	1.8mm (0.07")

OLED SPECIFICATIONS

Characteristics of Display

Display Device	Color OLED display module
Display Mode	Passive matrix
Viewing Area	21.28mm x 18.74mm (horizontal x vertical)
Pixel Format	96RGB x 64 pixels (horizontal x vertical)
Pixel Size	0.222mm x 0.293mm (horizontal x vertical)
Interface	Serial (SPI) interface
Number of Colors	65,536 Colors (16bit: R 5bit/G 6bit/B 5bit) or 256 Colors (8bit: R 2bit/G 3bit/B 3bit)
Operating Temperature Range	-20°C ~ +70°C (-4°F ~ +158°F)
Storage Temperature Range	-30°C ~ +80°C (-22°F ~ +176°F)
Operating Life (Display)	50,000 hours @ 100cd/m ² (based on 40% pixels ON; Ta = 77°F)

Absolute Maximum Ratings

Items	Symbols	Ratings
Supply Voltage for Logic/Interface	V _{DD}	-0.3V to +4.0V
Supply Voltage for Drive	V _{CC}	-0.0V to +19.0V
Input Voltage	V _I	-0.3V to V _{DD} +0.3V

Current Consumption

(Temperature at 25°C, V_{DD} = 2.8V, V_{CC} = 15.0V)

Items	Symbols	Min	Typical	Max
All-Pixels-On Mode *Drive System Power Current	I _{CC1}	—	11.0mA	13.2mA
All-Pixels-On Mode *Logic/IF System Power Current	I _{DD1}	—	0.17mA	0.20mA
Sleep Mode **Drive System Power Current	I _{CC2}	—	—	10µA
Sleep Mode **Logic/IF System Power Current	I _{DD2}	—	—	10µA

* All pixels shall be turned on with the maximum level gray scale

** All pixels shall be turned off (while chip is operating)

Recommended Operating Conditions

Items	Symbols	Minimum	Typical	Maximum
Supply Voltage for Logic/Interface	V _{DD}	2.4V	2.8V	3.5V
Supply Voltage for Drive	V _{CC}	14.0V	15.0V	16.0V
Input High Level Voltage	V _{IH}	0.8 x V _{DD}	—	—
Input Low Level Voltage	V _{IL}	—	—	0.2 x V _{DD}

Optical Characteristics (Temperature at 25°C, Initial Value: 87 x 0F)

Items	Min	Typical	Max	Unit	Remarks
Luminosity	80	105	130	cd/m ²	White (All pixels on)
White Color Coordinate	(x)	0.26	0.30	0.34	—
	(y)	0.31	0.36	0.41	—
Red Color Coordinate	(x)	0.62	0.66	0.70	—
	(y)	0.30	0.34	0.38	—
Green Color Coordinate	(x)	0.24	0.29	0.33	—
	(y)	0.59	0.63	0.67	—
Blue Color Coordinate	(x)	0.10	0.15	0.19	—
	(y)	0.10	0.17	0.23	—
Contrast Ratio	100	—	—	—	—

Toggles
 Rockers
 Pushbuttons
 Illuminated PB
 Programmable
 Keylocks
 Rotaries
 Slides
 Tactiles
 Tilt
 Touch
 Indicators
 Accessories
 Supplement

BLOCK DIAGRAM & PIN CONFIGURATIONS



ISF15ACP4

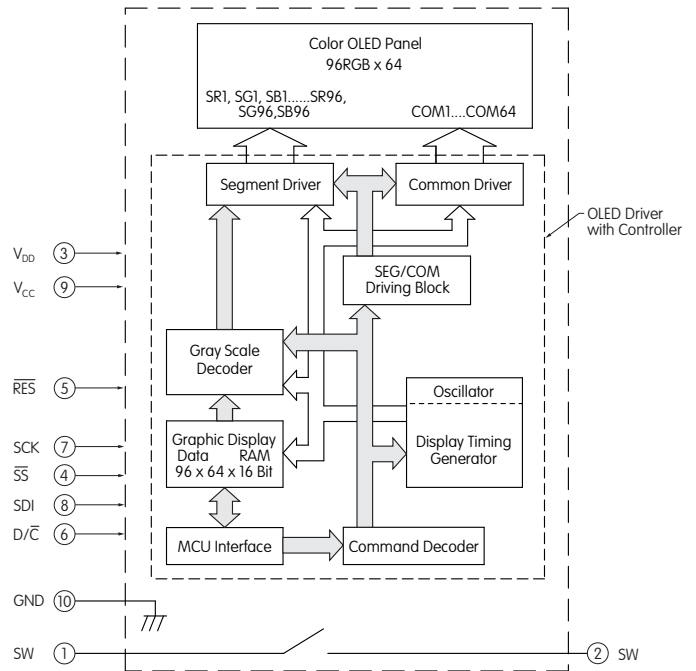

Pin No.	Symbol	Name	Function
①	SW	Terminal of Switch	Normally open
②	SW	Terminal of Switch	Normally open
③	V _{DD}	Power	Power source for logic circuit
④	SS	Slave Select	Slave select for SPI. This line is active low.
⑤	RES	Reset	Reset signal input. When pin is low, initialization of chip is executed.
⑥	D/C	Data/Command	Data/Command Control. When pin is pulled low, data will be interpreted as Command; when pulled high, data will be interpreted as Data.
⑦	SCK	Serial Clock	Clock line for SPI that synchronizes command and data
⑧	SDI	Serial Data In	Data input line for SPI
⑨	V _{CC}	Power	Power source for drive circuit
⑩	GND	Ground	Connect to Ground

TYPICAL SWITCH DIMENSIONS

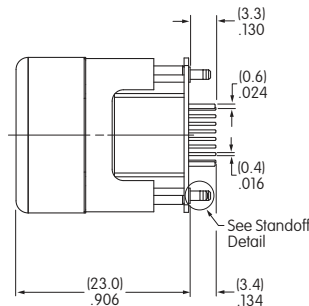
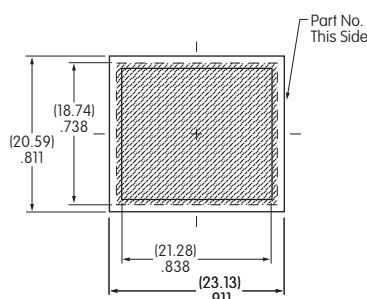

Terminal numbers are not on the switch.

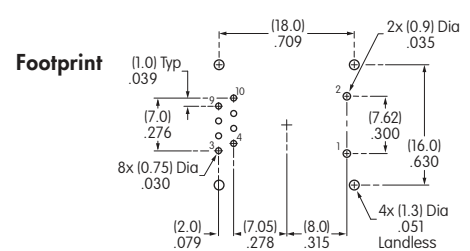
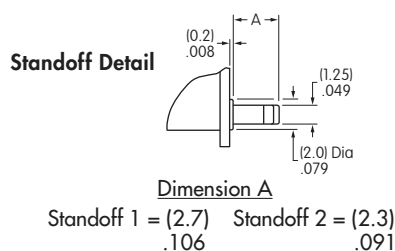
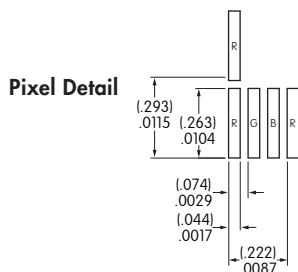
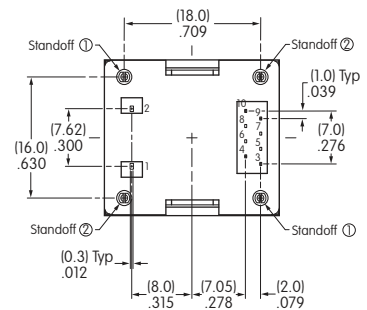

TIMING SPECIFICATIONS

AC Characteristics (Temperature at 25°C), $V_{DD} = 2.4V \sim 3.5V$

Items	Symbols	Minimum	Typical	Maximum
Clock Cycle Time	t_{cycle}	150ns	—	—
D/ \bar{C} Setup Time	t_{AS}	40ns	—	—
D/ \bar{C} Hold Time	t_{AH}	40ns	—	—
\bar{SS} Setup Time	t_{CSS}	75ns	—	—
\bar{SS} Hold Time	t_{CSH}	60ns	—	—
Write Data Setup Time	t_{DSW}	40ns	—	—
Write Data Hold Time	t_{DHW}	40ns	—	—
SCK Low Time	t_{CLKL}	75ns	—	—
SCK High Time	t_{CLKH}	75ns	—	—
SCK Rise Time	t_R	—	—	15ns
SCK Fall Time	t_F	—	—	15ns

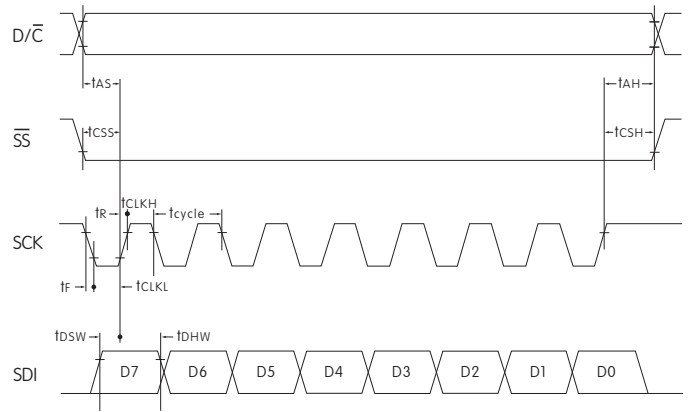

STATE TRANSITION

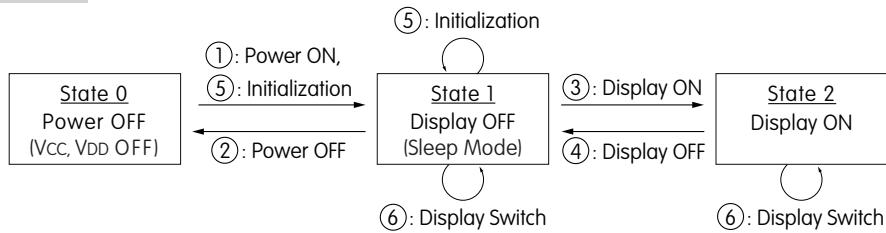

State Number	State	Display	Sleep	V_{CC}	V_{DD}	Changing the Display
0	Power OFF	OFF	—	OFF	OFF	Disable
1	Display OFF	OFF	ON	ON	ON	Enable
2	Display ON	ON	OFF	ON	ON	Enable

State Transition	Transition	Index
①	Power ON	Refer to "Power ON/OFF Sequence"
②	Power OFF	
③	Display ON	
④	Display OFF	
⑤	Initialization	Initialize Setting of Command/Data
⑥	Image Rewriting	Send Display Data
	Display Settings	Dimmer, Scroll, etc.

Power ON/OFF Sequence

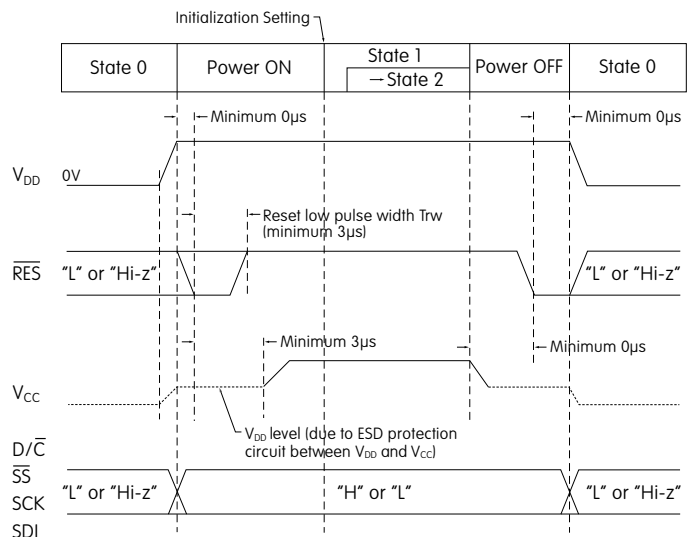

PRECAUTIONS FOR HANDLING & STORAGE OF OLED PUSHBUTTONS & DISPLAY

Handling



1. The IS Series OLED devices are electrostatic sensitive. To avoid damage to IC, do not touch terminals unless properly isolated from static electricity.
2. Signal input under conditions not recommended may cause damage to the OLED unit or deterioration of the display. Follow directions regarding supply sequences of power and signal voltages.
3. If the OLED panel is broken, avoid touching the contents. Wash off any contact to the skin or clothing.
4. Limit operating force to switch keytop to 100.0N maximum, as excessive pressure may damage the OLED.
5. For OLED display, it is necessary for bracket legs to be Grounded.
6. Recommended soldering time and temperature limits for OLED switch or display:
 Avoid temperatures exceeding 80°C at the OLED.
 Wave Soldering: see Profile A in Supplement section.
 Manual Soldering: see Profile A in Supplement section.
7. The IS series OLED devices are not process sealed.
8. Pixels acquire diminished brightness over time and use, and those most frequently habituated have greater reduction of brightness than those less used. To minimize this difference, operate OLED unit so that all pixels are used as consistently as possible.
9. For switch, clean cap surface with dry cloth. If further cleaning is needed, wipe with dampened cloth using neutral cleanser and dry with clean cloth. Do not use organic solvent. For display, avoid contact with any flux or detergent. If any liquids spill on display surface, immediately wipe with soft absorbent cloth.
10. Proper serial resistors and buffers for signals should be used to prevent noise problems.

Storage

1. Store in original container and away from direct sunlight.
2. Keep away from static electricity.
3. Avoid extreme temperatures, high humidity, gaseous substances, and all forms of chemical contamination.

Toggles

Rockers

Pushbuttons

Illuminated PB

Programmable
E

Keylocks

Rotaries

Slides

Tactiles

Tilt

Touch

Indicators

Accessories

Supplement

OPTIONAL ACCESSORIES

AT9704-085K Socket for LCD 64 x 32 Pushbutton

Materials:

Base - Glass Fiber Reinforced PBT
 Terminals - Brass/Beryllium Copper

Compatible Part Number for AT9704-085K

Long Travel LCD 64 x 32

IS15EBFP4RGB

- The socket permits the switch to be plugged in after automated processing.
- Use of the socket enables easy field replacement of the device.

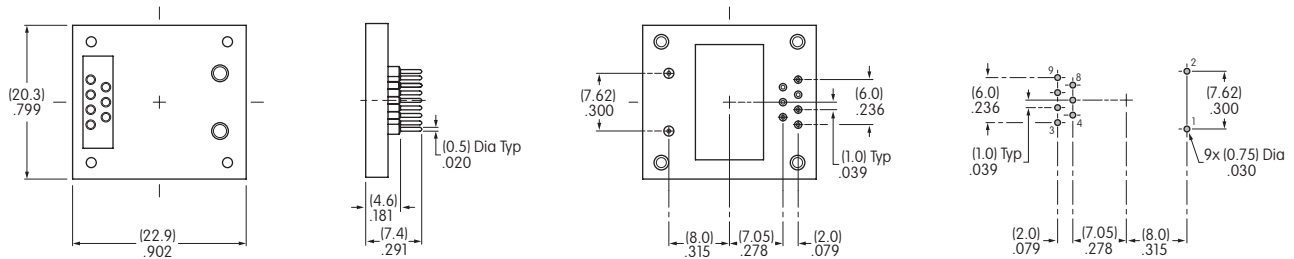

AT9704-085L Socket for OLED Pushbutton

Materials:

Base - Glass Fiber Reinforced PBT
 Terminals - Brass/Beryllium Copper

Compatible Part Numbers for AT9704-085L

OLED Pushbutton

Frameless OLED

ISC15ANP4

ISF15ACP4

- The socket permits the OLED switch to be plugged in after automated processing.
- Use of the socket enables easy field replacement of the device.

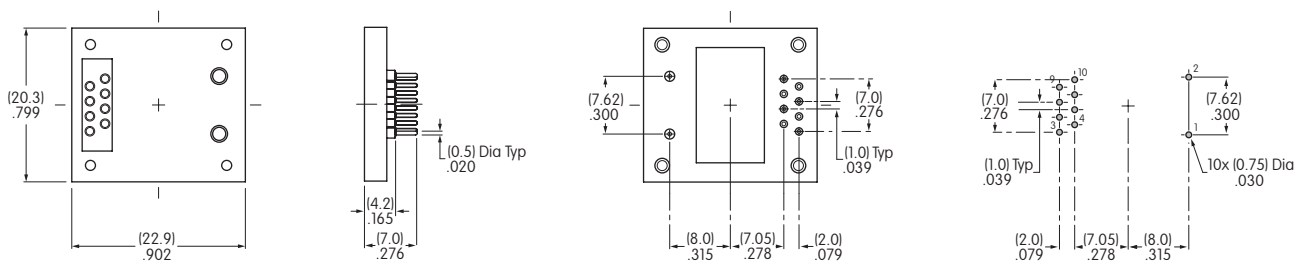

AT9704-085M Socket for OLED Display

Materials:

Base - Glass Fiber Reinforced PBT
 Terminals - Brass/Beryllium Copper

Compatible Part Number for AT9704-085M

OLED Display

ISC01P

- The socket permits the OLED display to be plugged in after automated processing.
- Use of the socket enables easy field replacement of the device.

