

Unpublished copy not to be reproduced without written permission of AMP Incorporated

PART NUMBER	KEYING POSITION
204708-1	01
-2	02
-3	03
-4	04
-5	05
-6	06
-7	07
-8	08
-9	09
1-	01
1-	04

REVISION RECORD			
0	RELEASED WAS 5048-417	945	9-22-69
A	REV. PER. ECN A-294 A-319	299	1-8-70
B	REV. PER. ECN A-528	10	5/1/70
C	ADDED 1-1-4 ECN J-843	10/1/70	10/1/70
D	ECO-09-009005	PY	5-09 DE
E	ECO-10-003957	PY	3-10 DE

MARKING LOCATED HERE

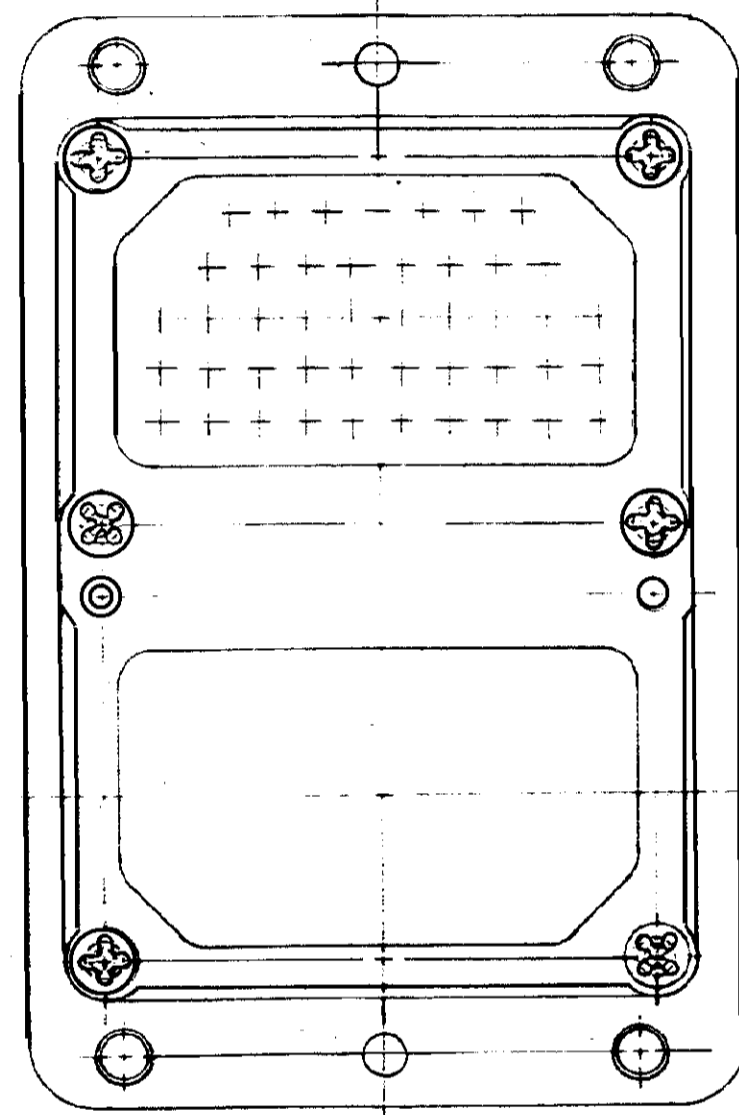
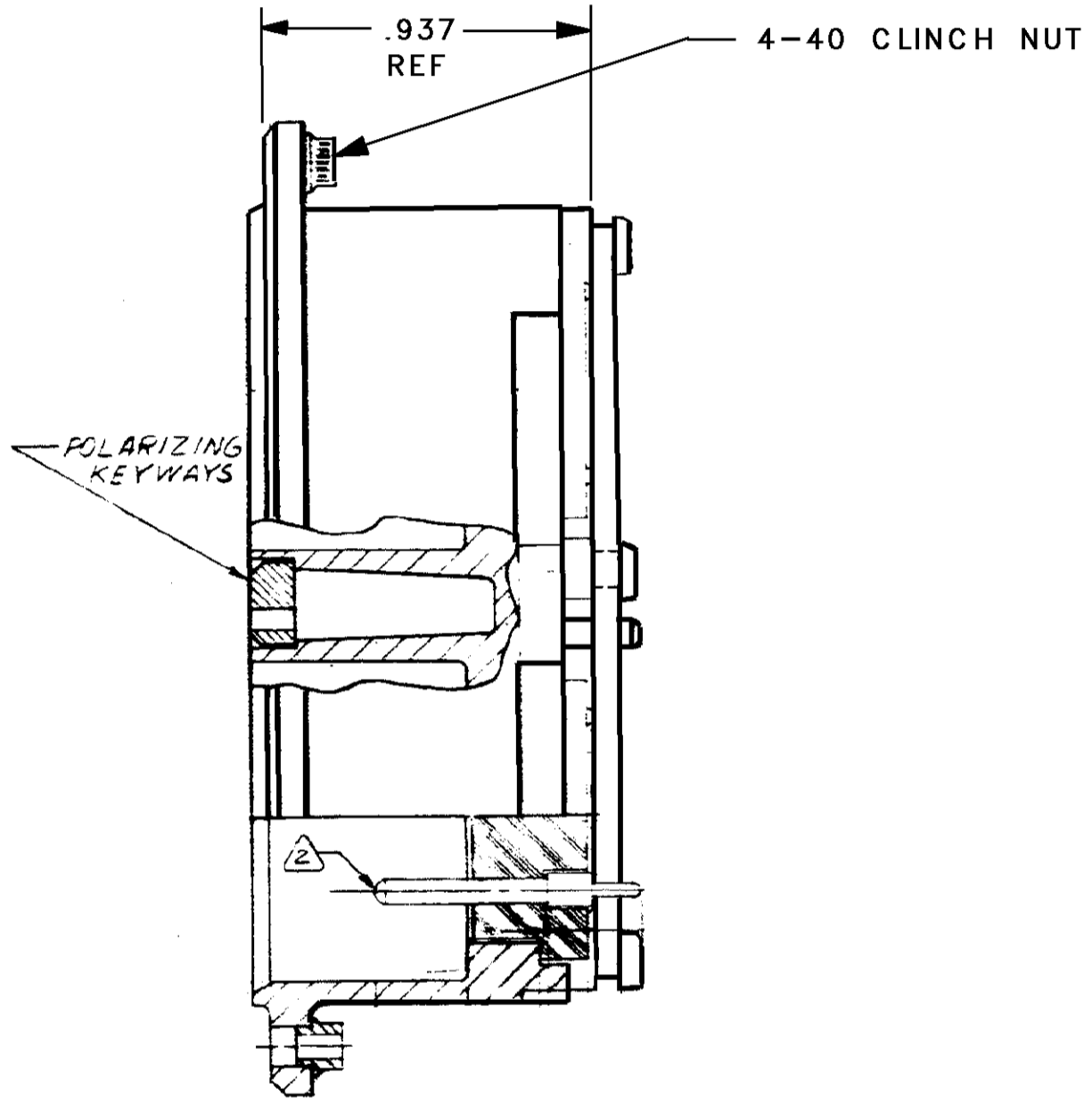
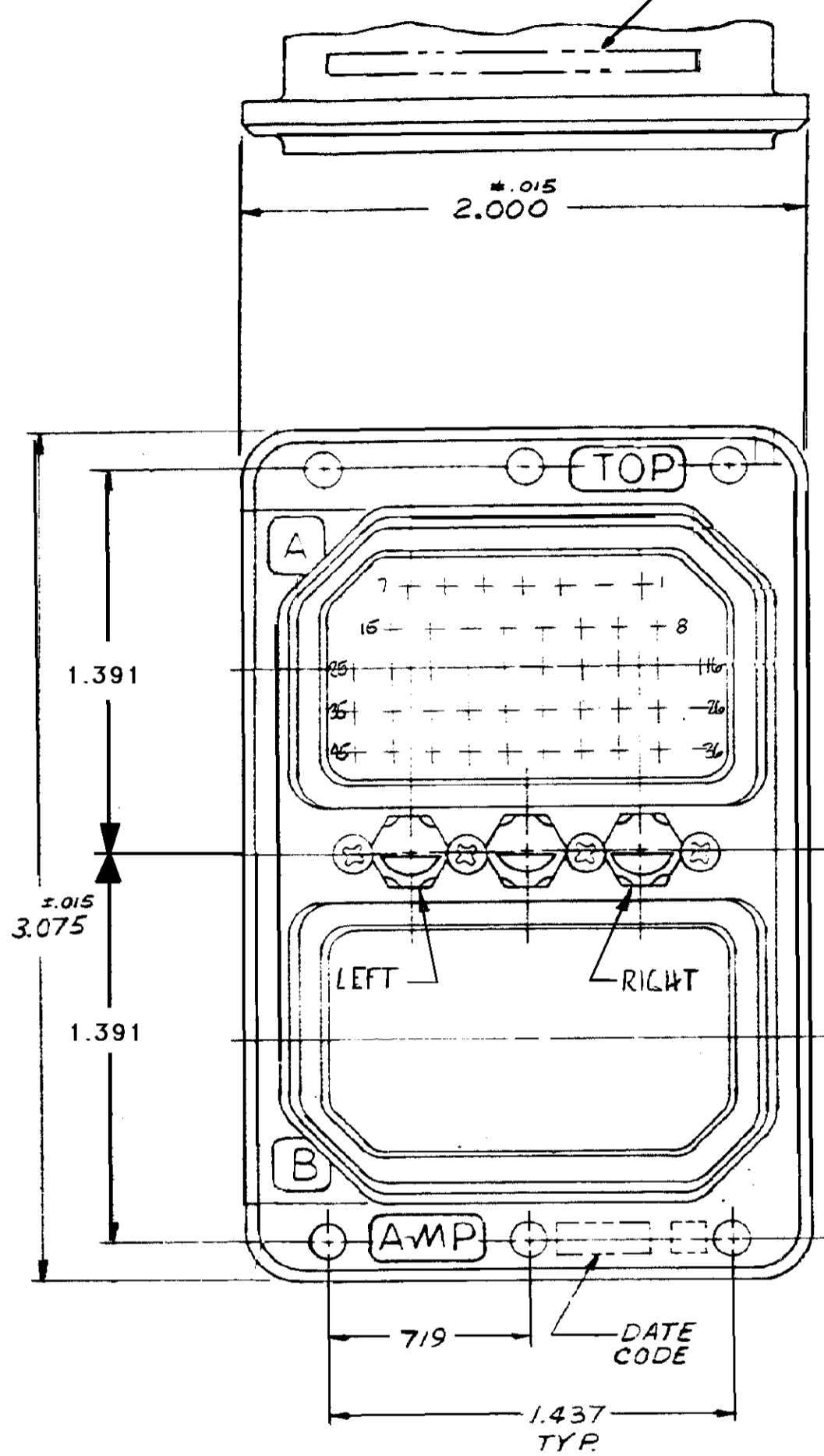

NOTES:

CONTACTS ARE SHOWN IN POSITION FOR ILLUSTRATION ONLY. FOR SHIPMENT, CONTACTS ARE INSTALLED IN INSULATOR & PIN PROTECTOR COVER PLACED OVER CONTACTS ARE INCLUDED IN A CONTAINER WITHIN THE CONNECTOR PACKAGE.

MATERIAL & FINISH

SHELL: DIE CAST ALUMINUM ALLOY PER FED. SPEC. QQ-A-591, COMP. 10.
 FINISH: (-1 TO -9) BLACK ANODIZE
 FINISH: (1-1 & 1--4) CADMIUM PLATE, YELLOW CHROMATE CONVERSION
 SCREWS: STAINLESS STEEL, PASSIVATED
 WASHER: PHENOLIC
 INSULATORS HARD: EPOXY
 POLARIZING KEY INSERTS: STAINLESS STEEL, PASSIVATED

TOLERANCES .XXX .005 ANGLES 2 DEGREES	AMP INCORPORATED MILWAUKEE, WISCONSIN	
	INSTALLATION, ELECTRICAL CONNECTOR, RECEPTACLE RACK & PANEL AM 2R 45P 45P	
MATERIAL SEE CALLOUT	DATE	REV
	10-9-69 10-9-69 10/9/69	E
REV	00779	204708
2-1	SHEET	

CUSTOMER DRAWING

204708