

**OptiMOS™2 + OptiMOS™-P 2 Small Signal Transistor**
**Features**

- Complementary P + N channel
- Enhancement mode
- Super Logic level (2.5V rated)
- Common drain
- Avalanche rated
- 175 °C operating temperature
- Qualified according to AEC Q101
- 100% lead-free; RoHS compliant
- Halogen-free according to IEC61246-21

**Product Summary**

		P	N	
$V_{DS}$		-20	20	V
$R_{DS(on),max}$	$V_{GS}=\pm 4.5\text{ V}$	150	55	mΩ
	$V_{GS}=\pm 2.5\text{ V}$	310	95	
$I_D$		-3.2	5.1	A

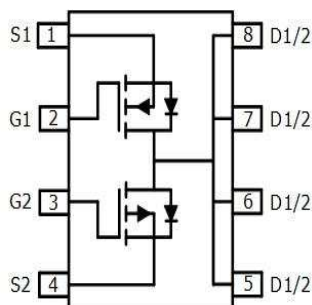

Type	Package	Marking	Lead Free	Halogen Free	Packing
BSZ215C H	PG-TSDSON-8 LTI	215C	Yes	Yes	Non dry

**Maximum ratings**, at  $T_j=25\text{ °C}$ , unless otherwise specified <sup>1)</sup>

Parameter	Symbol	Conditions	Value		Unit
			P	N	
Continuous drain current	$I_D$	$T_A=25\text{ °C}$	-3.2	5.1	A
		$T_A=100\text{ °C}$	-2.2	3.6	
Pulsed drain current	$I_{D,pulse}$	$T_A=25\text{ °C}$	-13	20	
Avalanche energy, single pulse	$E_{AS}$	P: $I_D=-3.2\text{ A}$ , N: $I_D=5.1\text{ A}$ , $R_{GS}=25\text{ }\Omega$	11	11	mJ
Gate source voltage	$V_{GS}$		$\pm 12$		V
Power dissipation	$P_{tot}^{2)}$	$T_A=25\text{ °C}$	2.5		W
Operating and storage temperature	$T_j, T_{stg}$		-55 ... 175		°C
ESD class		JESD22-A114-HBM	0 (<250V)		
Soldering temperature	$T_{solder}$		260		°C
IEC climatic category; DIN IEC 68-1			55/175/56		

<sup>1)</sup> Remark: only one of both transistors active

Parameter	Symbol	Conditions	Values			Unit
			min.	typ.	max.	

**Thermal characteristics**

Thermal resistance, junction - case	P	$R_{thJC}$		-	-	8	K/W
	N						
Device on PCB		$R_{thJA}$	6 cm <sup>2</sup> cooling area <sup>2)</sup>	-	-	60	K/W

**Electrical characteristics, at  $T_j=25\text{ }^\circ\text{C}$ , unless otherwise specified**
**Static characteristics**

Drain-source breakdown voltage	P	$V_{(BR)DSS}$	$V_{GS}=0\text{ V}, I_D=-250\text{ }\mu\text{A}$	-	-	-20	V
	N		$V_{GS}=0\text{ V}, I_D=250\text{ }\mu\text{A}$	20	-	-	
Gate threshold voltage	P	$V_{GS(th)}$	$V_{DS}=V_{GS}, I_D=-110\text{ }\mu\text{A}$	-1.4	-1.0	-0.7	
	N		$V_{DS}=V_{GS}, I_D=110\text{ }\mu\text{A}$	0.8	1.1	1.4	
Zero gate voltage drain current	P	$I_{DSS}$	$V_{DS}=-20\text{ V}, V_{GS}=0\text{ V}, T_j=25\text{ }^\circ\text{C}$	-	-	-0.1	$\mu\text{A}$
	N		$V_{DS}=20\text{ V}, V_{GS}=0\text{ V}, T_j=25\text{ }^\circ\text{C}$	-	-	0.1	
	P		$V_{DS}=-20\text{ V}, V_{GS}=0\text{ V}, T_j=175\text{ }^\circ\text{C}$	-	-	-50	
	N		$V_{DS}=20\text{ V}, V_{GS}=0\text{ V}, T_j=175\text{ }^\circ\text{C}$	-	-	50	
Gate-source leakage current	P	$I_{GSS}$	$V_{GS}=\pm 12\text{ V}, V_{DS}=0\text{ V}$	-	-	$\pm 100$	nA
	N						
Drain-source on-state resistance	P	$R_{DS(on)}$	$V_{GS}=-2.5\text{ V}, I_D=2.1\text{ A}$	-	144	310	m $\Omega$
	N		$V_{GS}=2.5\text{ V}, I_D=1.9\text{ A}$	-	63	95	
	P		$V_{GS}=-4.5\text{ V}, I_D=-3.2\text{ A}$	-	95	150	
	N		$V_{GS}=4.5\text{ V}, I_D=5.1\text{ A}$	-	41	55	
Transconductance	P	$g_{fs}$	$ V_{DS} >2 I_D R_{DS(on)max}, I_D=-2.2\text{ A}$	4	7.9	-	S
	N		$ V_{DS} >2 I_D R_{DS(on)max}, I_D=3.6\text{ A}$	5.5	11	-	

<sup>2)</sup> Device on 40 mm x 40 mm x 1.5 mm epoxy PCB FR4 with 6 cm<sup>2</sup> (one layer, 70  $\mu\text{m}$  thick) copper area for drain connection. PCB is vertical in still air.

Parameter	Symbol	Conditions	Values			Unit
			min.	typ.	max.	

**Dynamic characteristics**

Input capacitance	P	$C_{iss}$	$V_{GS}=0\text{ V}$ , P: $V_{DS}=-10\text{ V}$ , N: $V_{DS}=10\text{ V}$ , $f=1\text{ MHz}$	-	300	400	pF			
	N			-	315	419				
Output capacitance	P	$C_{oss}$		P: $V_{DD}=-10\text{ V}$ , $V_{GS}=-4.5\text{ V}$ , $R_G=6\ \Omega$ , $I_D=-3.2\text{ A}$	-	92	120			
	N				-	114	152			
Reverse transfer capacitance	P	$C_{rss}$			N: $V_{DD}=10\text{ V}$ , $V_{GS}=4.5\text{ V}$ , $R_G=6\ \Omega$ , $I_D=5.1\text{ A}$	-	92	140		
	N					-	16	24		
Turn-on delay time	P	$t_{d(on)}$				P: $V_{DD}=-10\text{ V}$ , $V_{GS}=-4.5\text{ V}$ , $R_G=6\ \Omega$ , $I_D=-3.2\text{ A}$	-	7.4	-	ns
	N						-	4.9	-	
Rise time	P	$t_r$	N: $V_{DD}=10\text{ V}$ , $V_{GS}=4.5\text{ V}$ , $R_G=6\ \Omega$ , $I_D=5.1\text{ A}$				-	3.7	-	
	N						-	2.0	-	
Turn-off delay time	P	$t_{d(off)}$		N: $V_{DD}=10\text{ V}$ , $V_{GS}=4.5\text{ V}$ , $R_G=6\ \Omega$ , $I_D=5.1\text{ A}$			-	11.3	-	
	N						-	12.2	-	
Fall time	P	$t_f$			N: $V_{DD}=10\text{ V}$ , $V_{GS}=4.5\text{ V}$ , $R_G=6\ \Omega$ , $I_D=5.1\text{ A}$		-	4.7	-	
	N						-	1.4	-	

**Gate Charge Characteristics**

Gate to source charge	P	$Q_{gs}$	$V_{DD}=-10\text{ V}$ , $I_D=-3.2\text{ A}$ , $V_{GS}=0\text{ to }-4.5\text{ V}$	-	-0.58	-0.8	nC
Gate to drain charge		$Q_{gd}$		-	-1.3	-1.7	
Switching charge		$Q_g$		-	-3.0	-4.6	
Gate plateau voltage		$V_{plateau}$		-	-1.9	-	
Gate to source charge	N	$Q_{gs}$	$V_{DD}=10\text{ V}$ , $I_D=5.1\text{ A}$ , $V_{GS}=0\text{ to }4.5\text{ V}$	-	0.7	1.0	
Gate to drain charge		$Q_{gd}$		-	0.4	-	
Switching charge		$Q_g$		-	2.1	2.8	
Gate plateau voltage		$V_{plateau}$		-	2.3	-	

Parameter	Symbol	Conditions	Values			Unit	
			min.	typ.	max.		
<b>Reverse Diode</b>							
Diode continuous forward current	P	$I_S$	$T_C=25\text{ °C}$	-	-	-2.1	A
	N					2.3	
Diode pulse current	P	$I_{S,pulse}$		-	-	-13	
	N					20	
Diode forward voltage	P	$V_{SD}$	$V_{GS}=0\text{ V}, I_F=3.2\text{ A},$ $T_j=25\text{ °C}$	-	-0.98	-1.2	V
	N		$V_{GS}=0\text{ V}, I_F=5.1\text{ A},$ $T_j=25\text{ °C}$	-	0.9	1.2	
Reverse recovery time	P	$t_{rr}$	$V_R=\pm 10\text{ V}, I_F=I_S,$ $di_F/dt=100\text{ A}/\mu\text{s}$		12.2		ns
	N			-	10.9	-	
Reverse recovery charge	P	$Q_{rr}$				4.6	nC
	N			-	3.4	-	

**1 Power dissipation (P)**

$P_{tot}=f(T_A)$

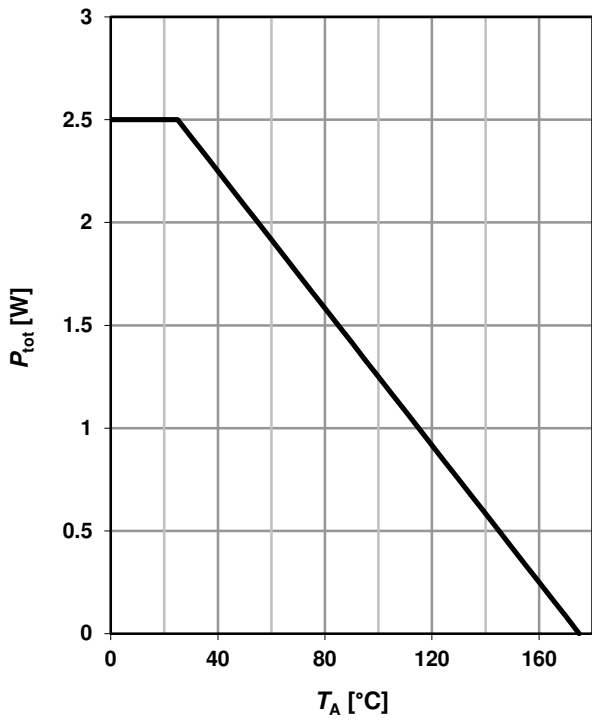

**2 Power dissipation (N)**

$P_{tot}=f(T_A)$

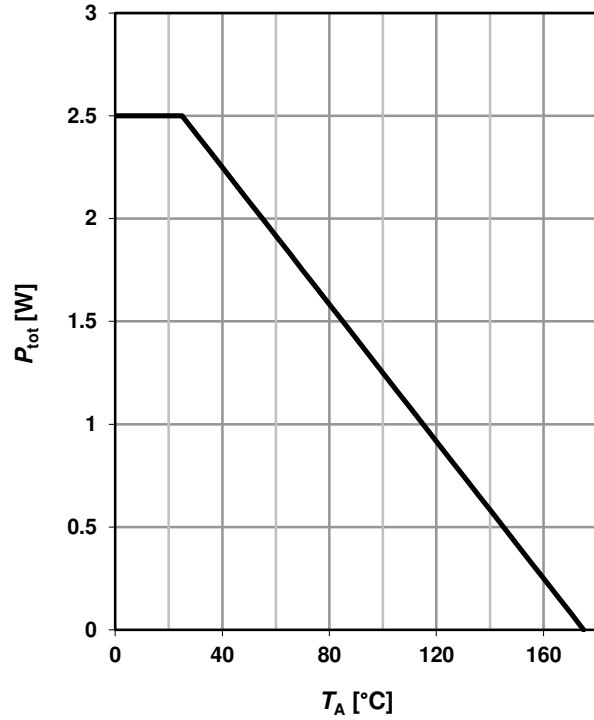

**3 Drain current (P)**

$I_D=f(T_A)$

parameter:  $V_{GS} \leq 4.5$  V

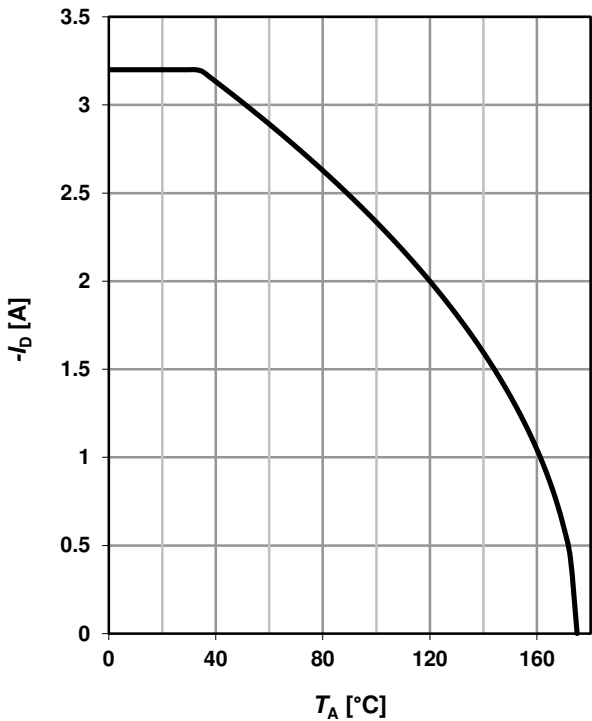

**4 Drain current (N)**

$I_D=f(T_A)$

parameter:  $V_{GS} \geq 4.5$  V

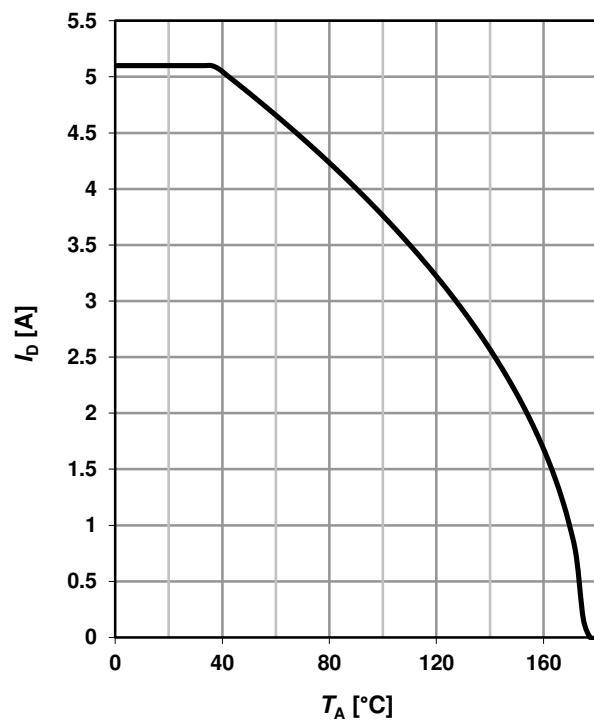

**5 Safe operating area (P)**

$$I_D = f(V_{DS}); T_A = 25\text{ °C}; D = 0$$

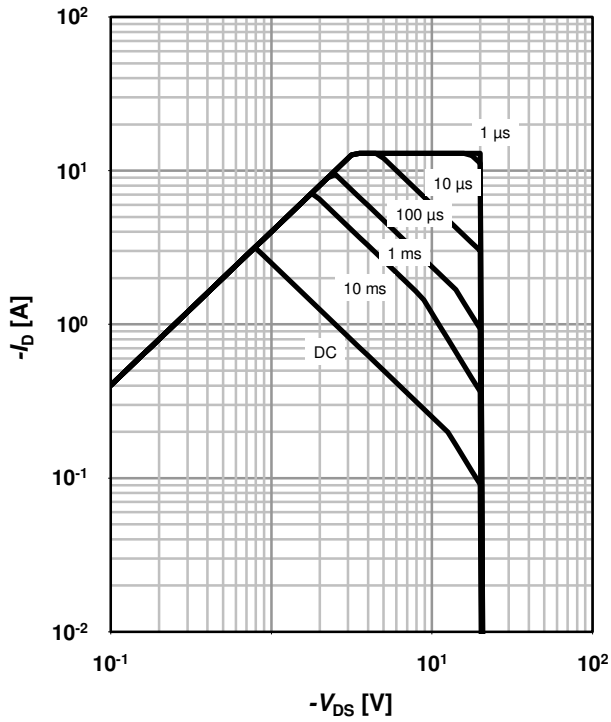
 parameter:  $t_p$ 

**6 Safe operating area (N)**

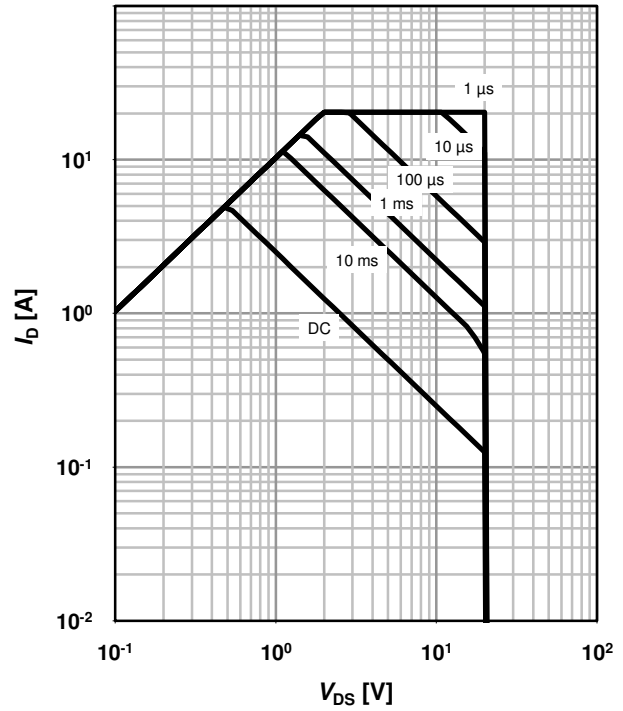
$$I_D = f(V_{DS}); T_A = 25\text{ °C}; D = 0$$

 parameter:  $t_p$ 

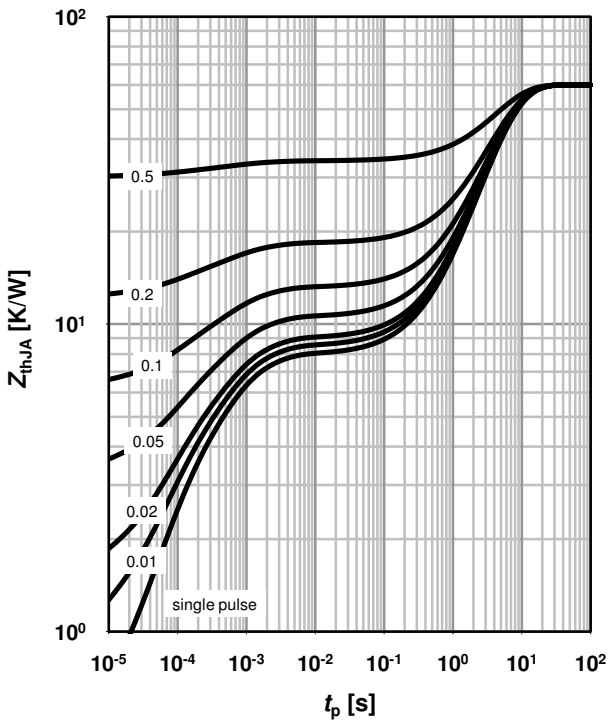
**7 Max. transient thermal impedance (P)**

$$Z_{thJA} = f(t_p)$$

 parameter:  $D = t_p/T$ 

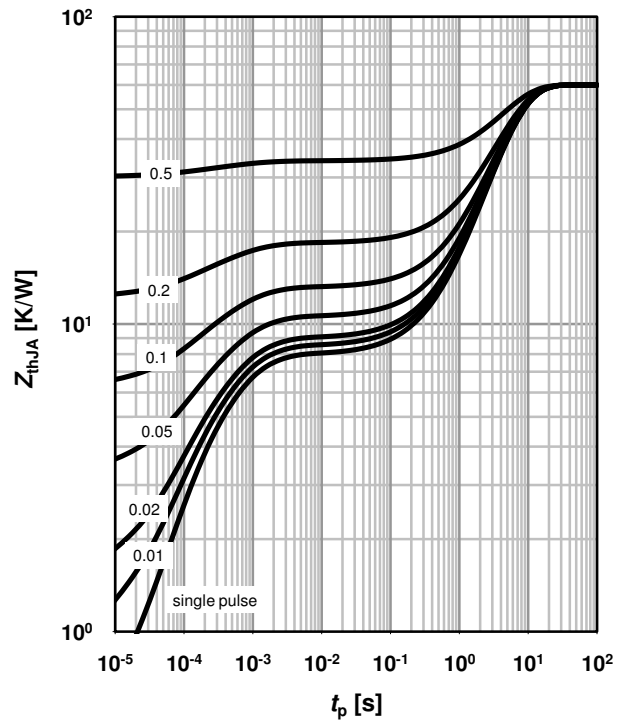
**8 Max. transient thermal impedance (N)**

$$Z_{thJA} = f(t_p)$$

 parameter:  $D = t_p/T$ 

**9 Typ. output characteristics (P)**

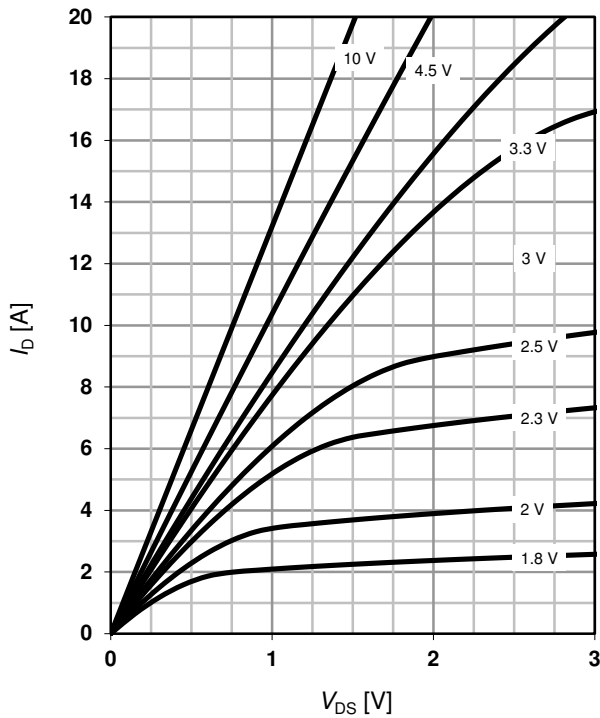
$$I_D = f(V_{DS}); T_j = 25\text{ }^\circ\text{C}$$

 parameter:  $V_{GS}$ 

**10 Typ. output characteristics (N)**

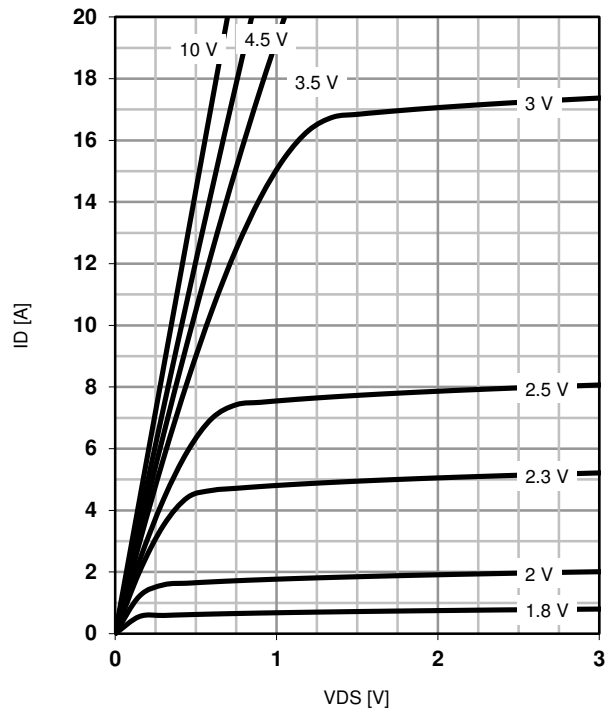
$$I_D = f(V_{DS}); T_j = 25\text{ }^\circ\text{C}$$

 parameter:  $V_{GS}$ 

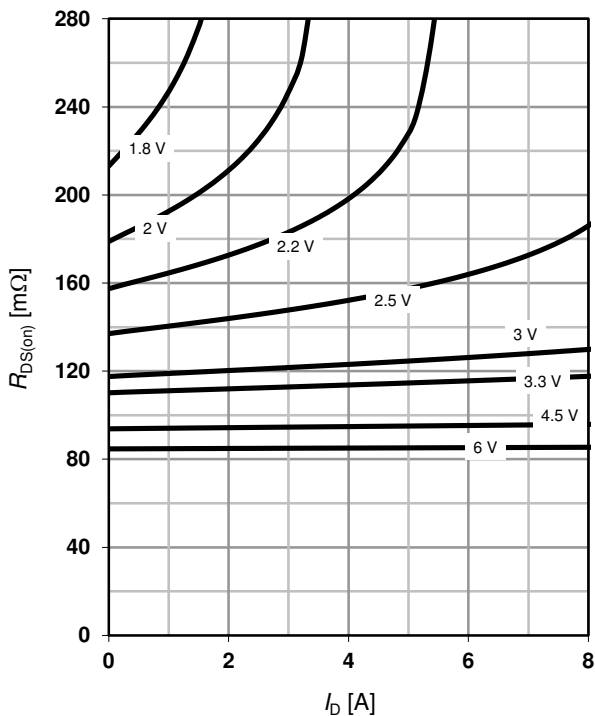
**11 Typ. drain-source on resistance (P)**

$$R_{DS(on)} = f(I_D); T_j = 25\text{ }^\circ\text{C}$$

 parameter:  $V_{GS}$ 

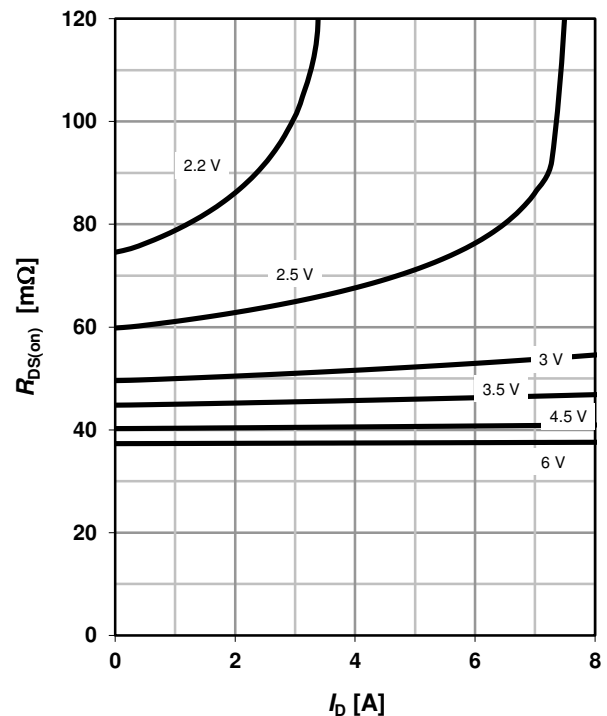
**12 Typ. drain-source on resistance (N)**

$$R_{DS(on)} = f(I_D); T_j = 25\text{ }^\circ\text{C}$$

 parameter:  $V_{GS}$ 

**13 Typ. transfer characteristics (P)**

$$I_D = f(V_{GS}); |V_{DS}| > 2 |I_D| R_{DS(on)max}$$

parameter:  $T_j$

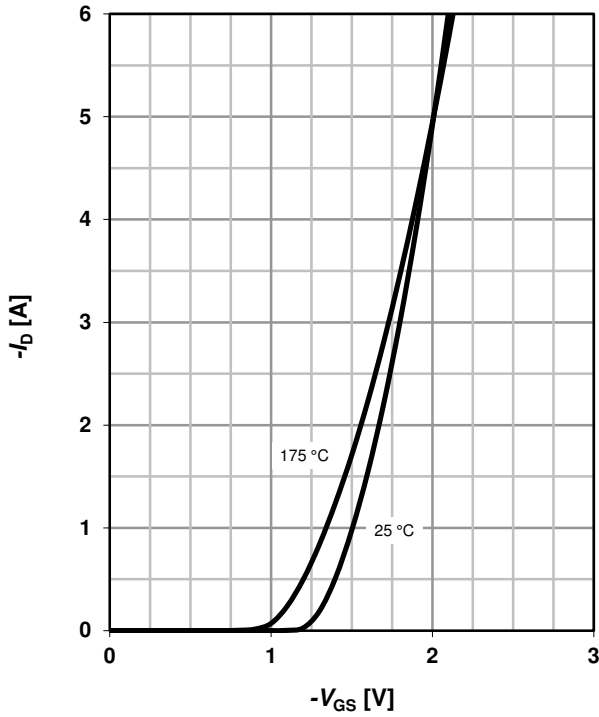

**14 Typ. transfer characteristics (N)**

$$I_D = f(V_{GS}); |V_{DS}| > 2 |I_D| R_{DS(on)max}$$

parameter:  $T_j$

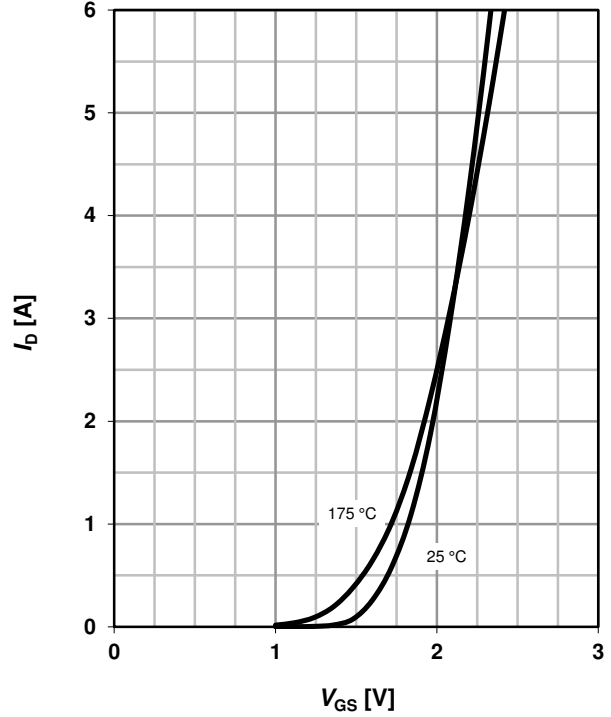

**15 Drain-source on-state resistance (P)**

$$R_{DS(on)} = f(T_j); I_D = -3.2 A; V_{GS} = -4.5 V$$

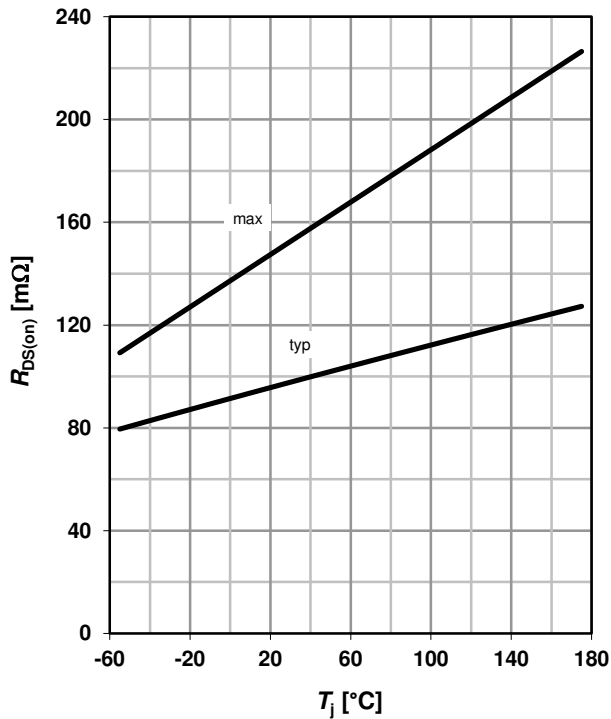

**16 Drain-source on-state resistance (N)**

$$R_{DS(on)} = f(T_j); I_D = 5.1 A; V_{GS} = 4.5 V$$

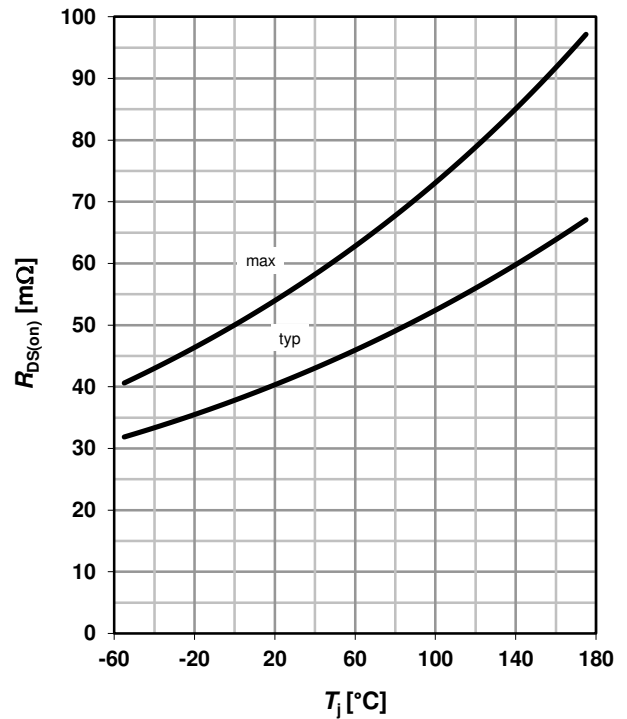



**17 Typ. gate threshold voltage (P)**

$$V_{GS(th)}=f(T_j); V_{GS}=V_{DS}; I_D=-110 \mu A$$

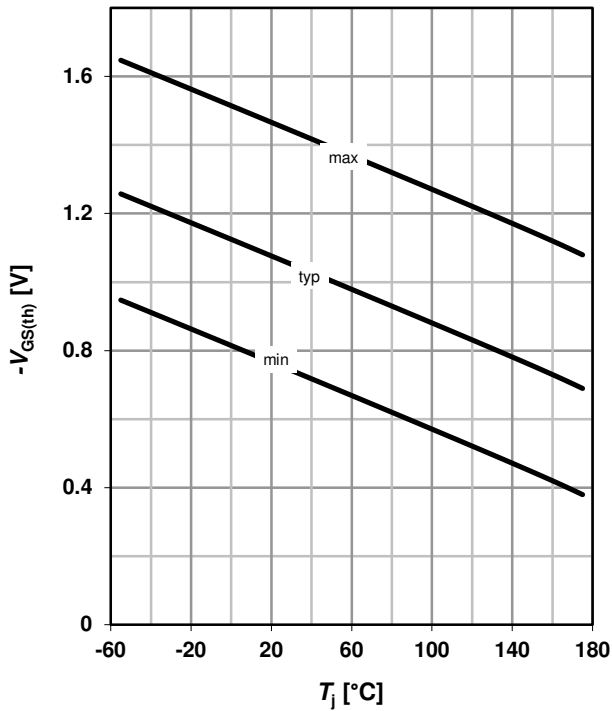
**18 Typ. gate threshold voltage (N)**

$$V_{GS(th)}=f(T_j); V_{GS}=V_{DS}; I_D=110 \mu A$$

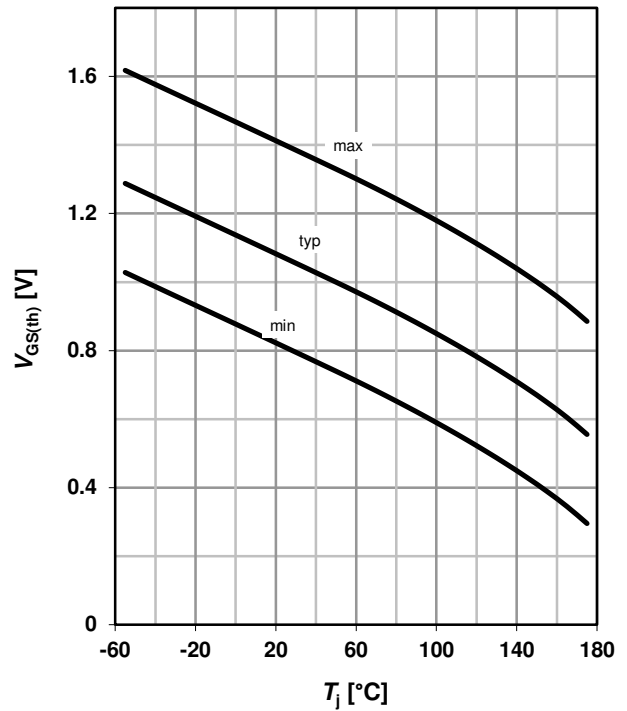
**19 Typ. capacitances (P)**

$$C=f(V_{DS}); V_{GS}=0 V; f=1 MHz$$

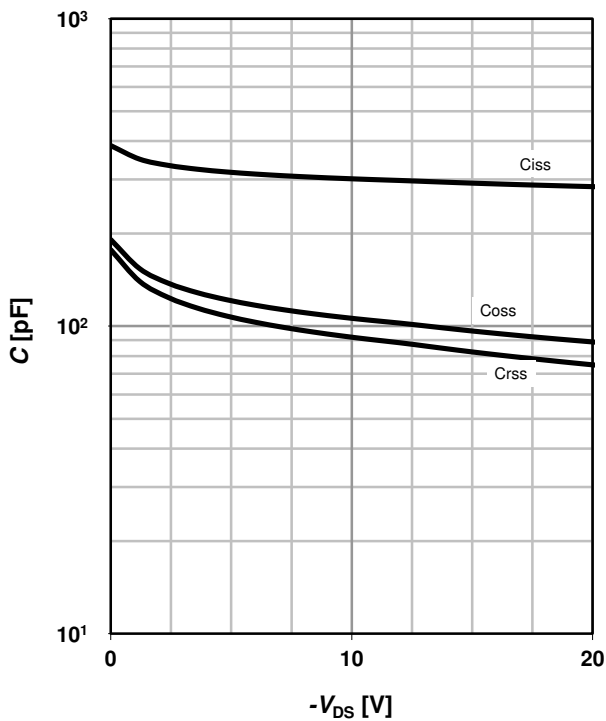

**20 Typ. capacitances (N)**

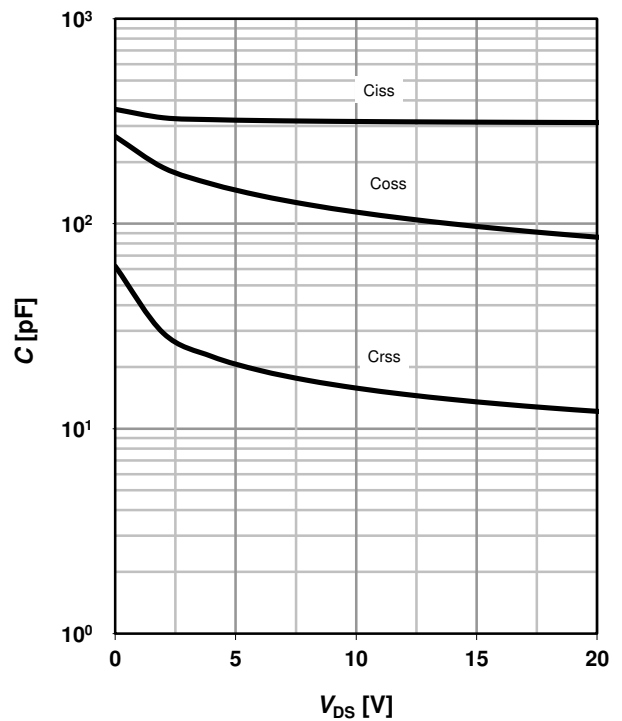
$$C=f(V_{DS}); V_{GS}=0 V; f=1 MHz$$

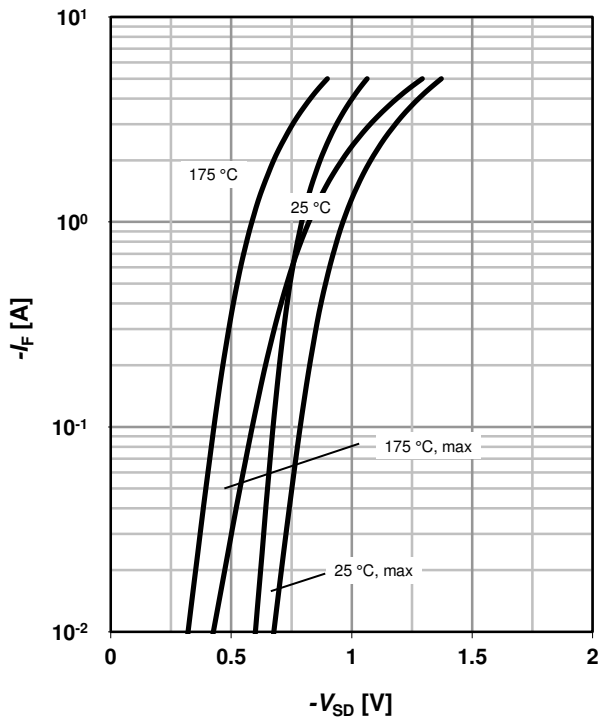

**21 Forward characteristics of reverse diode (P)**

$$I_F = f(V_{SD})$$

 parameter:  $T_j$ 

**22 Forward characteristics of reverse diode (N)**

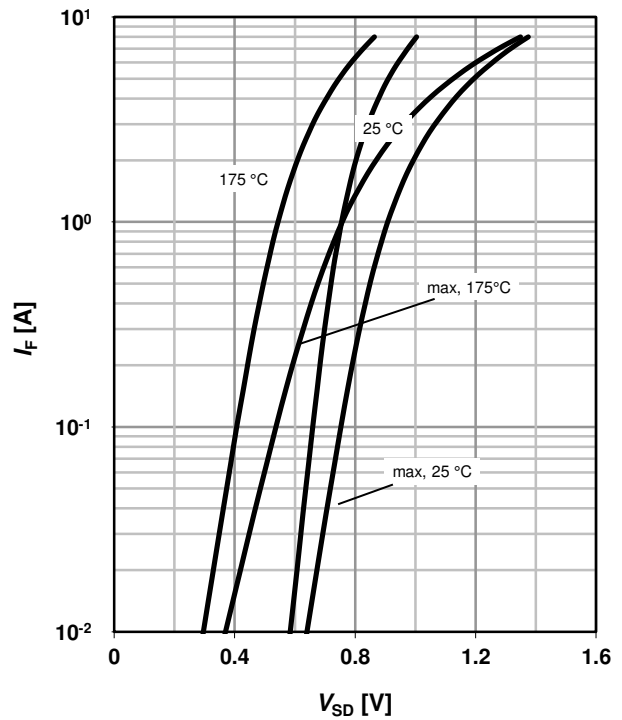
$$I_F = f(V_{SD})$$

 parameter:  $T_j$ 

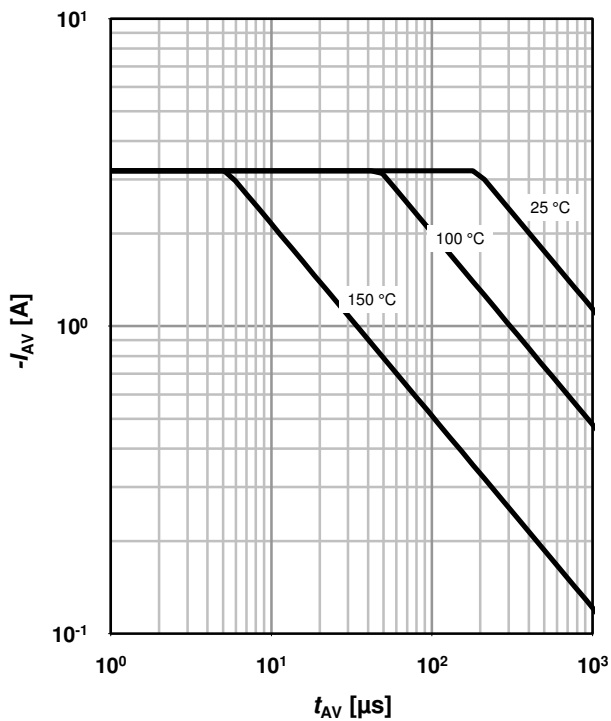
**23 Avalanche characteristics (P)**

$$I_{AS} = f(t_{AV}); R_{GS} = 25 \Omega$$

 parameter:  $T_{j(start)}$ 

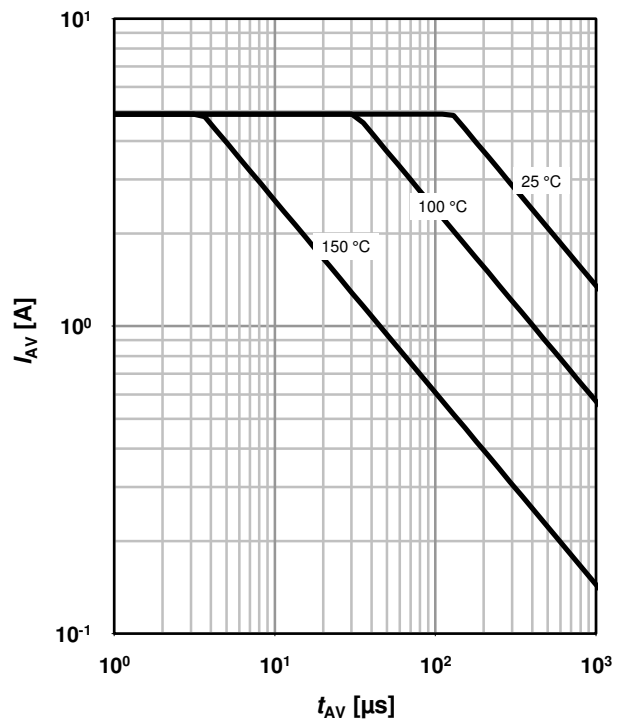
**24 Avalanche characteristics (N)**

$$I_{AS} = f(t_{AV}); R_{GS} = 25 \Omega$$

 parameter:  $T_{j(start)}$ 

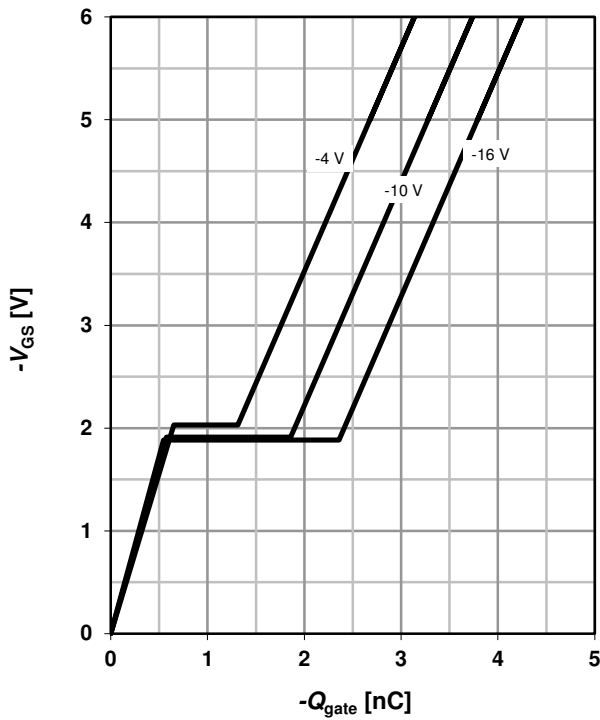
**25 Typ. gate charge (P)**
 $V_{GS}=f(Q_{gate}); I_D=-3.2A$  pulsed

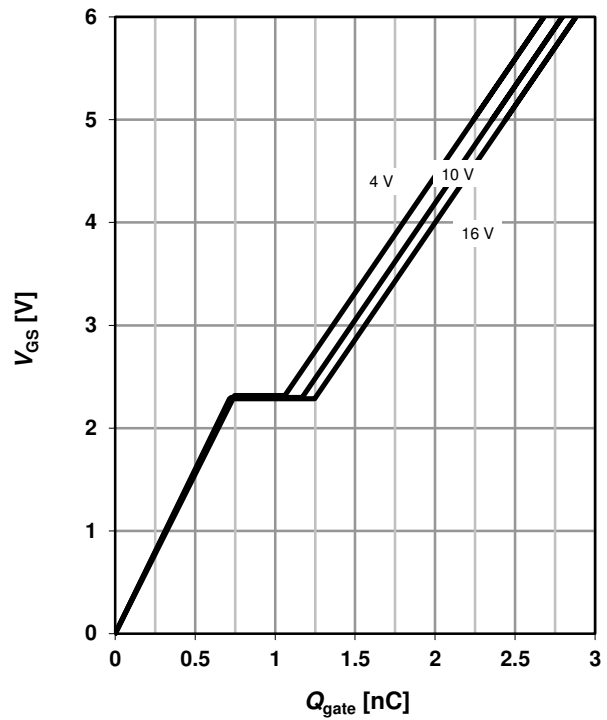
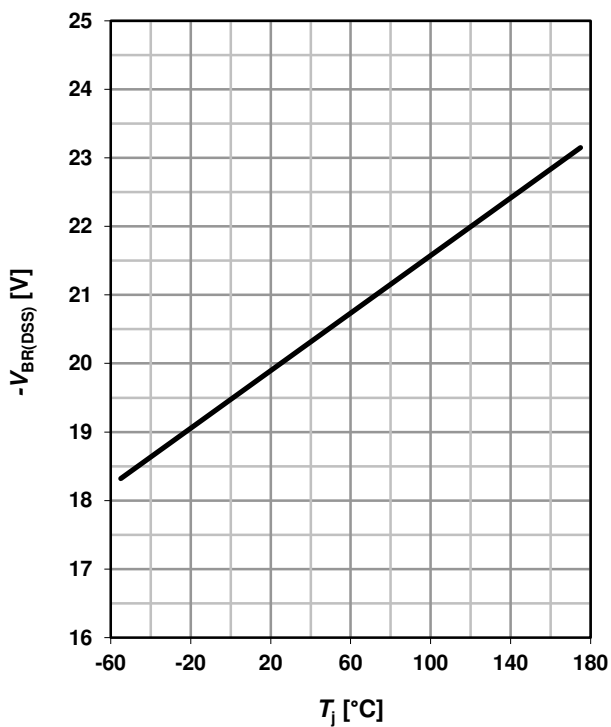
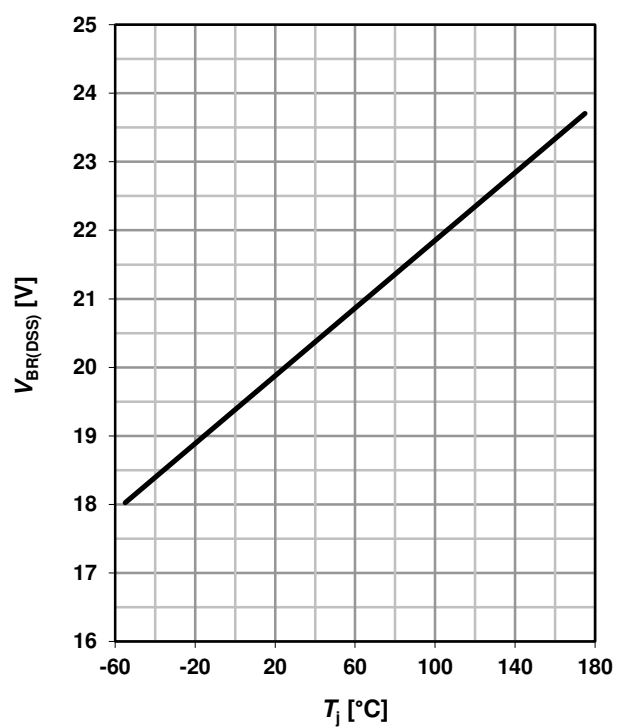
 parameter:  $V_{DD}$ 

**26 Typ. gate charge (N)**
 $V_{GS}=f(Q_{gate}); I_D=5.1A$  pulsed

 parameter:  $V_{DD}$ 

**27 Drain-source breakdown voltage (P)**
 $V_{BR(DSS)}=f(T_j); I_D=-250 \mu A$ 

**28 Drain-source breakdown voltage (N)**
 $V_{BR(DSS)}=f(T_j); I_D=250 \mu A$ 

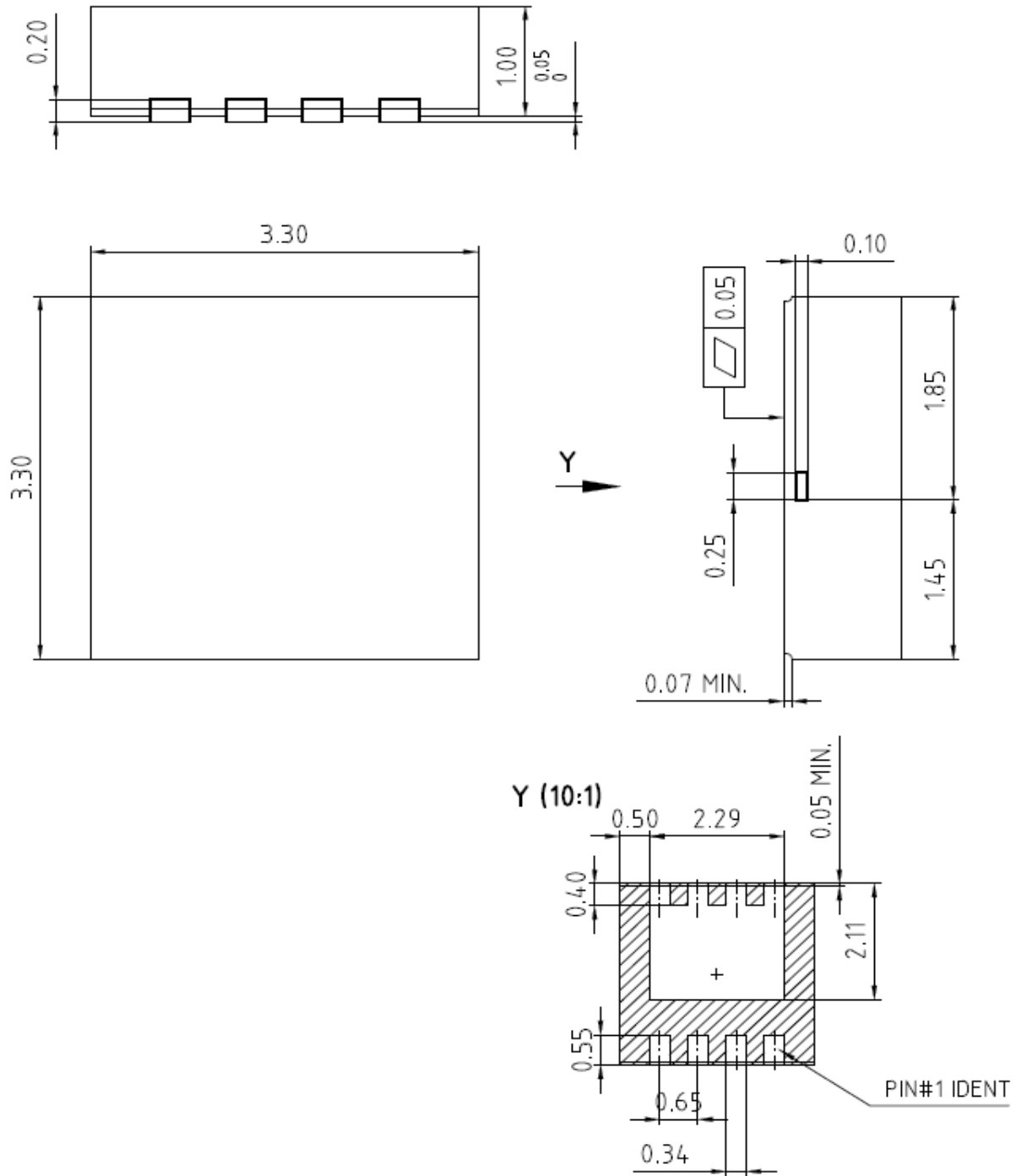
Package Outline

PG-TSDSON-8LTI

PG-TSDSON-8LTI : Outline



Dimensions in mm

# 20V OptiMOS™ 2 Small Signal Transistor

## BSZ215C H

### Revision History

BSZ215C H

**Revision: 2016-10-06, Rev. 2.3**

Previous Revision

Revision	Date	Subjects (major changes since last revision)
2.3	2016-10-06	Update package drawing

#### Trademarks of Infineon Technologies AG

AURIX™, C166™, CanPAK™, CIPOS™, CoolGaN™, CoolMOS™, CoolSET™, CoolSiC™, CORECONTROL™, CROSSAVE™, DAVE™, DI-POL™, DrBlade™, EasyPIM™, EconoBRIDGE™, EconoDUAL™, EconoPACK™, EconoPIM™, EiceDRIVER™, eupec™, FCOS™, HITFET™, HybridPACK™, Infineon™, ISOFACE™, IsoPACK™, i-Wafer™, MIPAQ™, ModSTACK™, my-d™, NovalithIC™, OmniTune™, OPTIGA™, OptiMOS™, ORIGA™, POWERCODE™, PRIMARION™, PrimePACK™, PrimeSTACK™, PROFET™, PRO-SIL™, RASIC™, REAL3™, ReverSave™, SatRIC™, SIEGET™, SIPMOS™, SmartLEWIS™, SOLID FLASH™, SPOC™, TEMPFET™, thinQ!™, TRENCHSTOP™, TriCore™.

Trademarks updated August 2015

#### Other Trademarks

All referenced product or service names and trademarks are the property of their respective owners.

#### We Listen to Your Comments

Any information within this document that you feel is wrong, unclear or missing at all? Your feedback will help us to continuously improve the quality of this document. Please send your proposal (including a reference to this document) to:

[erratum@infineon.com](mailto:erratum@infineon.com)

#### Published by

**Infineon Technologies AG**

**81726 München, Germany**

**© 2016 Infineon Technologies AG**

**All Rights Reserved.**

#### Legal Disclaimer

The information given in this document shall in no event be regarded as a guarantee of conditions or characteristics ("Beschaffheitsgarantie").

With respect to any examples, hints or any typical values stated herein and/or any information regarding the application of the product, Infineon Technologies hereby disclaims any and all warranties and liabilities of any kind, including without limitation warranties of non-infringement of intellectual property rights of any third party.

In addition, any information given in this document is subject to customer's compliance with its obligations stated in this document and any applicable legal requirements, norms and standards concerning customer's products and any use of the product of Infineon Technologies in customer's applications.

The data contained in this document is exclusively intended for technically trained staff. It is the responsibility of customer's technical departments to evaluate the suitability of the product for the intended application and the completeness of the product information given in this document with respect to such application.

#### Information

For further information on technology, delivery terms and conditions and prices please contact your nearest Infineon Technologies Office ([www.infineon.com](http://www.infineon.com)).

#### Warnings

Due to technical requirements, components may contain dangerous substances. For information on the types in question, please contact the nearest Infineon Technologies Office.

The Infineon Technologies component described in this Data Sheet may be used in life-support devices or systems and/or automotive, aviation and aerospace applications or systems only with the express written approval of Infineon Technologies, if a failure of such components can reasonably be expected to cause the failure of that life-support, automotive, aviation and aerospace device or system or to affect the safety or effectiveness of that device or system. Life support devices or systems are intended to be implanted in the human body or to support and/or maintain and sustain and/or protect human life. If they fail, it is reasonable to assume that the health of the user or other persons may be endangered.