

REF. -49 OPT. SCREW
(WHERE APPLICABLE)

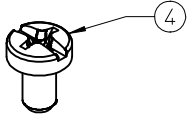

REF. -50 OPT. SCREW
(WHERE APPLICABLE)

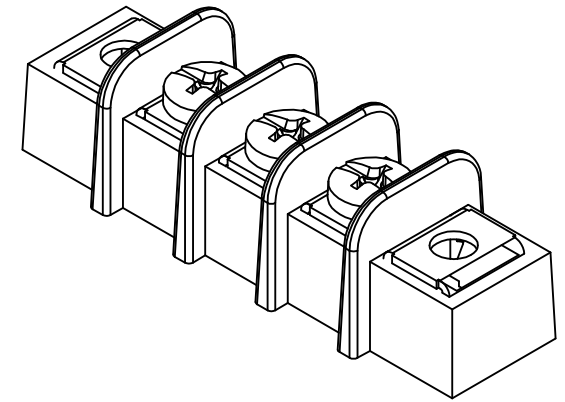
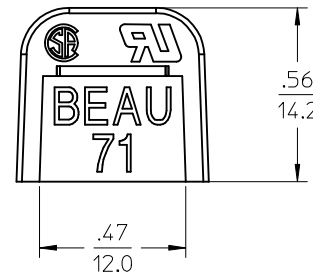
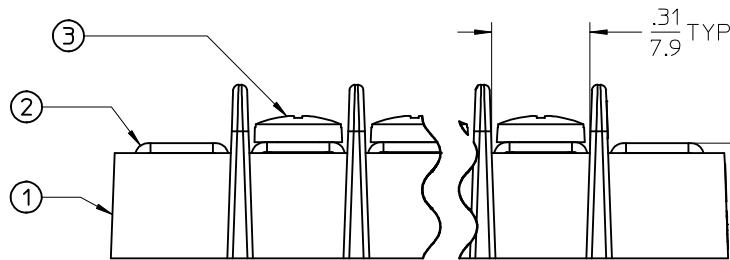
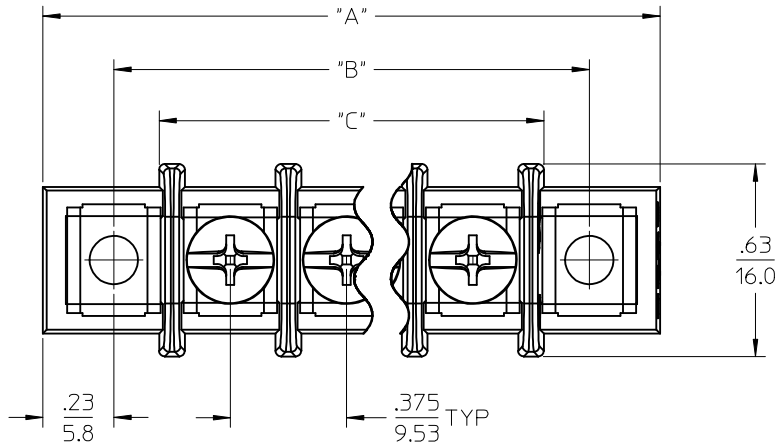
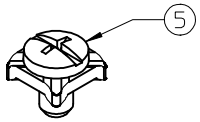

PART NUMBER LEGEND

71-1-XX-XX

SERIES

TERMINAL STYLE

CIRCUIT QTY (2 TO 26)

OPTION (-49 BRASS,PHIL/SLOT SCREW)

(-50 CLAMP WASHER,PHIL/SLOT SCREW)

NOTES:

1. MATERIAL: SEE TABLE.
2. FINISHES: SEE TABLE.
3. PRODUCT SPECIFICATION: PS-38710-001
4. "XX" REFERS TO NUMBER OF CIRCUITS.
5. ASSEMBLY IS RgHS COMPLIANT.

ITEM	QTY	DESCRIPTION	MATERIAL	FINISH
5	XX	#6-32 PH/SLOTTED SCREW W/WSHR (OPTION -50)	STEEL	ZINC
4	XX	#6-32 PH/SLOTTED SCREW (OPTION -49)	BRASS	NICKEL
3	XX	#6-32 PH/SLOTTED SCREW (STANDARD)	STEEL	ZINC
2	XX	MOUNTING PLATE	BRASS	NICKEL
1	1	INSULATOR	POLYESTER (PBT)	BLACK

RELEASED
EC NO: ICG2016-0008
DRAWN: SVMURTHY 2015/06/30
CHKD: RSTONE 2015/06/30
APPR: JFMURPHY 2016/07/11

QUALITY SYMBOLS
▽/0
▽/0
▽/0

GENERAL TOLERANCES (UNLESS SPECIFIED)

	mm	INCH
4 PLACES	± .005	± .0005
3 PLACES	± .01	± .001
2 PLACES	± 0.13	± .01
1 PLACE	± 0.3	± .012
0 PLACE	± .005	± .0005

ANGULAR ± 2°
DRAFT WHERE APPLICABLE
MUST REMAIN WITHIN DIMENSIONS

DIMENSION STYLE
IN/MM

DRAWN BY	DATE
SVMURTHY	2015/06/30
CHECKED BY	DATE
RSTONE	2015/06/30
APPROVED BY	DATE
JFMURPHY	2016/07/11

MATERIAL NO.
SEE SHEET 2

SCALE
2:1

DESIGN UNITS
INCH

THIRD ANGLE PROJECTION

TITLE
9.53MM [.375"] SR BTS
NO TERMINAL, MTG ENDS

molex

DOCUMENT NO.
SD-38710-0202

SHEET NO.
1 OF 2

THIS DRAWING CONTAINS INFORMATION THAT IS PROPRIETARY TO MOLEX INCORPORATED AND SHOULD NOT BE USED WITHOUT WRITTEN PERMISSION

# OF CIRCUITS "X"	DIM "A"		DIM "B"		DIM "C"	
	IN	MM	IN	MM	IN	MM
2	1.58	40	1.13	29	.83	21
3	1.96	50	1.50	38	1.21	31
4	2.33	59	1.88	48	1.58	40
5	2.71	69	2.25	57	1.96	50
6	3.08	78	2.63	67	2.33	59
7	3.46	88	3.00	76	2.71	69
8	3.83	97	3.38	86	3.08	78
9	4.21	107	3.75	95	3.46	88
10	4.58	116	4.13	105	3.83	97
11	4.96	126	4.50	114	4.21	107
12	5.33	135	4.88	124	4.58	116
13	5.71	145	5.25	133	4.96	126
14	6.08	154	5.63	143	5.33	135
15	6.46	164	6.00	152	5.71	145
16	6.83	173	6.38	162	6.08	155
17	7.21	183	6.75	171	6.46	164
18	7.58	193	7.13	181	6.83	174
19	7.96	202	7.50	191	7.21	183
20	8.33	212	7.88	200	7.58	193
21	8.71	221	8.25	210	7.96	202
22	9.08	231	8.63	219	8.33	212
23	9.46	240	9.00	229	8.71	221
24	9.83	250	9.38	238	9.08	231
25	10.21	259	9.75	248	9.46	240
26	10.58	269	10.13	257	9.83	250

RELEASED EC NO: IFC2016-0008 DRAWN: SVMURTHY 2015/06/30 CHKD: RSTONE 2015/06/30 APPR: JFMURPHY 2016/07/11	DESCRIPTION REV A	QUALITY SYMBOLS	GENERAL TOLERANCES (UNLESS SPECIFIED)	DIMENSION STYLE	SCALE	DESIGN UNITS	THIRD ANGLE PROJECTION
		$\nabla F/0$ $\nabla E/0$ $\nabla D/0$	mm INCH 4 PLACES ± --- ± --- 3 PLACES ± --- ± .005 2 PLACES ± 0.13 ± .01 1 PLACE ± 0.3 ± --- 0 PLACE ± --- ± ---	IN/MM	2:1	INCH	9.53MM [.375"] SR BTS NO TERMINAL, MTG ENDS
		ANGULAR ± 2 ° DRAFT WHERE APPLICABLE MUST REMAIN WITHIN DIMENSIONS	DRAWN BY DATE SVMURTHY 2015/06/30 CHECKED BY DATE RSTONE 2015/06/30 APPROVED BY DATE JFMURPHY 2016/07/11	MATERIAL NO. 387100202	DOCUMENT NO. SD-38710-0202	SHEET NO. 2 OF 2	
		THIS DRAWING CONTAINS INFORMATION THAT IS PROPRIETARY TO MOLEX INCORPORATED AND SHOULD NOT BE USED WITHOUT WRITTEN PERMISSION					