



MTA 156

TE Internal #: 4-640426-3

Rectangular Power Connectors, Connector Assembly, Receptacle, Wire-to-Board, 13 Position, 3.96 mm [.156 in] Centerline, Wire & Cable, MTA 156

[View on TE.com >](#)

Connectors > Power Connectors > Rectangular Power > Rectangular Power Connectors

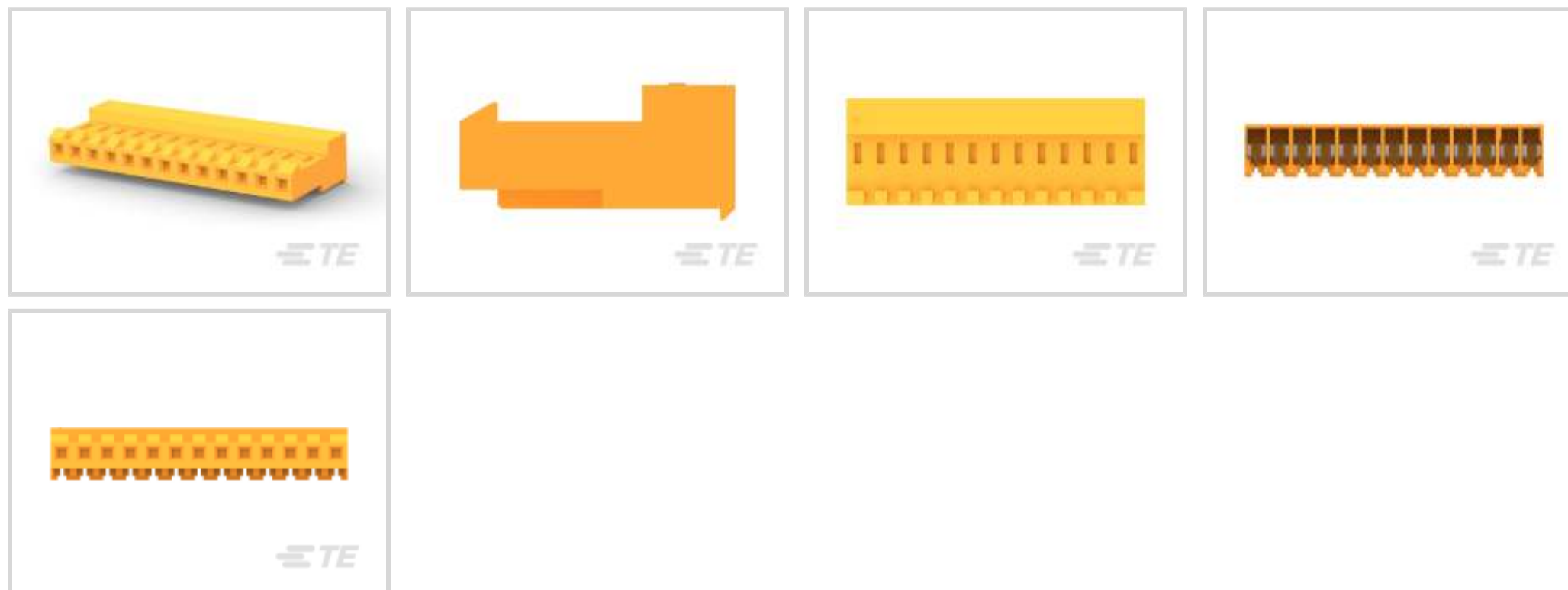

Rectangular Power Connector Type: **Connector Assembly**

Connector & Housing Type: **Receptacle**

Connector System: **Wire-to-Board**

Number of Positions: **13**

Centerline (Pitch): **3.96 mm [.156 in]**

Features

Product Type Features

Compatible With Discrete Wire Type	Stranded
Rectangular Power Connector Type	Connector Assembly
Connector & Housing Type	Receptacle
Connector System	Wire-to-Board
Sealable	No
Connector & Contact Terminates To	Wire & Cable

Configuration Features

Number of Positions	13
Number of Power Positions	13
Number of Rows	1

Electrical Characteristics

Operating Voltage	600 VAC
-------------------	---------

Body Features

Cable Exit Angle	90°
------------------	-----



Connector Profile	Standard
-------------------	----------

Contact Features

Contact Layout	Inline
Contact Underplating Material Thickness	30 µm [.762 µin]
Wire Contact Termination Area Plating Thickness	2.03 – 5.08 µm [80 – 200 µin]
Contact Mating Area Plating Material	Tin
Contact Mating Area Plating Material Finish	Matte
Contact Underplating Material	Nickel
Contact Base Material	Copper Alloy
Contact Current Rating (Max)	7 A
Contact Retention Within Housing	With
Contact Type	Receptacle
Wire Contact Termination Area Plating Material	Tin
Contact Mating Area Plating Material Thickness	2.03 – 5.08 µm [80 – 200 µin]

Termination Features

Termination Method to Wire & Cable	Insulation Displacement (IDC)
------------------------------------	-------------------------------

Mechanical Attachment

Strain Relief	With
Mating Retention	With
Mating Alignment	Without
Contact Retention Type Within Housing	Locking Lance
PCB Mount Alignment	Without
Panel Mount Feature	Without
PCB Mount Retention	Without
Mating Retention Type	Locking Ramp
Connector Mounting Type	Cable Mount (Free-Hanging)

Housing Features

Wire & Cable IDC Installation Type	Closed End
Centerline (Pitch)	3.96 mm [.156 in]
Housing Color	Orange
Housing Material	Nylon

Dimensions



Connector Height	9.02 mm[.355 in]
Product Length	51.51 mm[2.028 in]
Compatible Insulation Diameter Range	2.41 mm[.095 in]
Wire Size	.8 – .9 mm ²

Usage Conditions

Operating Temperature Range	-55 – 105 °C[-67 – 221 °F]
-----------------------------	----------------------------

Operation/Application

Circuit Application	Power
---------------------	-------

Industry Standards

CSA Rating	Certified, LR 7189
UL Rating	Recognized
Agency/Standard	CSA, UL
Approved Standards	UL E28476
UL Flammability Rating	UL 94V-2
Glow Wire Rating	Standard Part - Not Glow Wire

Packaging Features

Packaging Quantity	250
Packaging Method	Box & Carton

Product Compliance

[For compliance documentation, visit the product page on TE.com>](#)

EU RoHS Directive 2011/65/EU	Compliant
EU ELV Directive 2000/53/EC	Compliant
China RoHS 2 Directive MIIT Order No 32, 2016	No Restricted Materials Above Threshold
EU REACH Regulation (EC) No. 1907/2006	Current ECHA Candidate List: JUNE 2023 (235) Candidate List Declared Against: JUNE 2023 (235) Does not contain REACH SVHC
Halogen Content	Low Halogen - Br, Cl, F, I < 900 ppm per homogenous material. Also BFR/CFR/PVC Free
Solder Process Capability	Not applicable for solder process capability

Product Compliance Disclaimer

This information is provided based on reasonable inquiry of our suppliers and represents our current actual knowledge based on the information they provided. This information is subject to change. The part numbers that TE has identified as EU RoHS compliant have a maximum concentration of 0.1% by weight in homogenous materials for lead, hexavalent chromium, mercury, PBB, PBDE, DBP, BBP, DEHP, DIBP, and 0.01% for cadmium, or qualify for an exemption to these limits as defined in the Annexes of Directive 2011/65/EU (RoHS2). Finished electrical and electronic equipment products will be CE marked as required by Directive 2011/65/EU. Components may not be CE marked. Additionally, the part numbers that TE has identified as EU ELV compliant have a maximum concentration of 0.1% by weight in homogenous materials for lead, hexavalent chromium, and mercury, and 0.01% for cadmium, or qualify for an exemption to these limits as defined in the Annexes of Directive 2000/53/EC (ELV). Regarding the REACH Regulation, the information TE provides on SVHC in articles for this part number is based on the latest European Chemicals Agency (ECHA) 'Guidance on requirements for substances in articles' posted at this URL: <https://echa.europa.eu/guidance-documents/guidance-on-reach>

Compatible Parts



TE Part # 58074-1
MTA 50/100/156 MANUAL TOOL FRAME



TE Part # 59804-1
MAINTENANCE TOOL



TE Part # 1-640445-3
13P MTA156 HDR ASSY FL/STR SN



TE Part # 1-640389-3
13P MTA156 HDR ASSY SQ R/A F/L



TE Part # 1-640551-3
13P MTA156 COVER



TE Part # 58247-1
MTA 156 CRIMP HEAD REPAIR DISCRETE



TE Part # 1-644752-3
13P MTA156 HDR ASSY SQ STR F/L



TE Part # 1-640388-3
13P MTA156 HDR ASSY RN STR F/L



TE Part # 1-640383-3
13P MTA156 HDR ASSY STR SQ SN



TE Part # 1-643067-3
13P MTA156 MOLDED COVER



TE Part # 58247-3
MTA 156 CRIMP HEAD PRODUCTION RBBN CABLE



TE Part # 1-643071-3
13P MTA156 FD-THRU COVER



TE Part # 1-640384-3
13P MTA156 HDR ASSY STR RND SN



TE Part # 1-640385-3
13P MTA156 HDR ASSY SQ R/A



TE Part # 1-640643-3
13P MTA156 COVER F/T



TE Part # 1-644751-3
13P MTA156 HDR ASSY R/A



TE Part # 1-644753-3
13P MTA156 HDR ASSY RN STR F/L



TE Part # 58040-1
MTA 156 ARBOR FIXTURE DISCRETE RBN CABLE



TE Part # 58247-2
MTA 156 CRIMP HEAD PRODUCTION DISCRETE



TE Part # 58576-1
MTA 156 PNEUMATIC TOOL FOR BOARD FIXTURE

Also in the Series | MTA 156

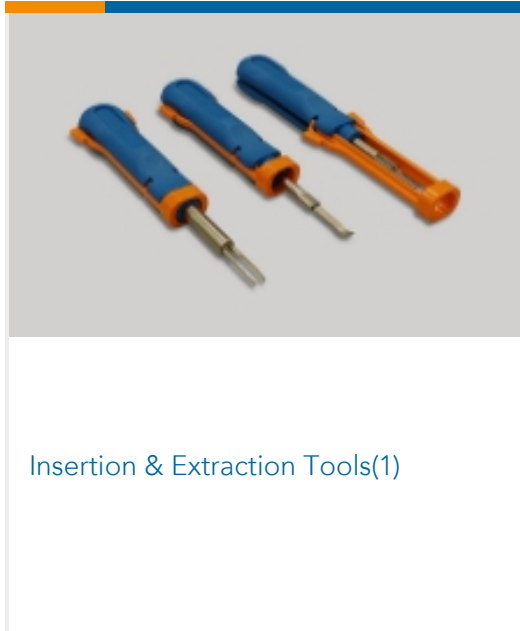

Insertion & Extraction Tools(1)

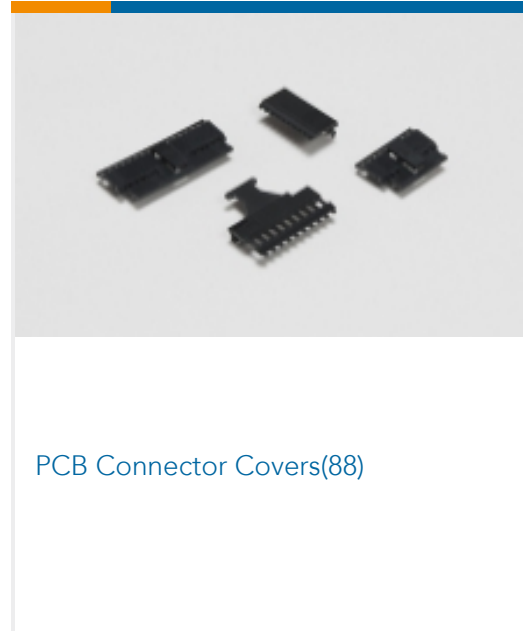

PCB Connector Covers(88)

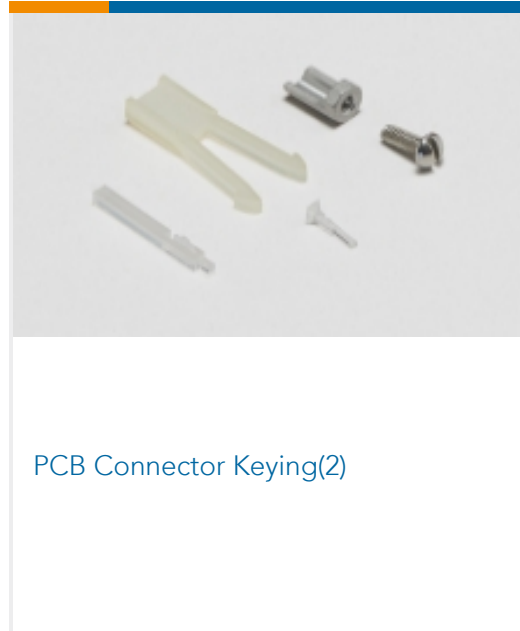

PCB Connector Keying(2)

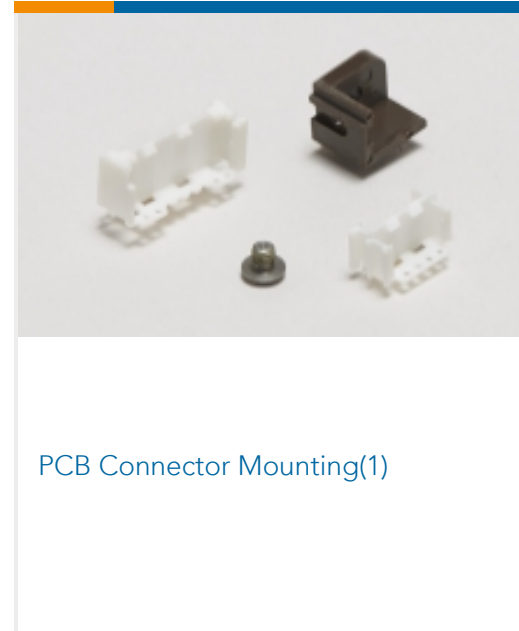

PCB Connector Mounting(1)



PCB Headers & Receptacles(316)

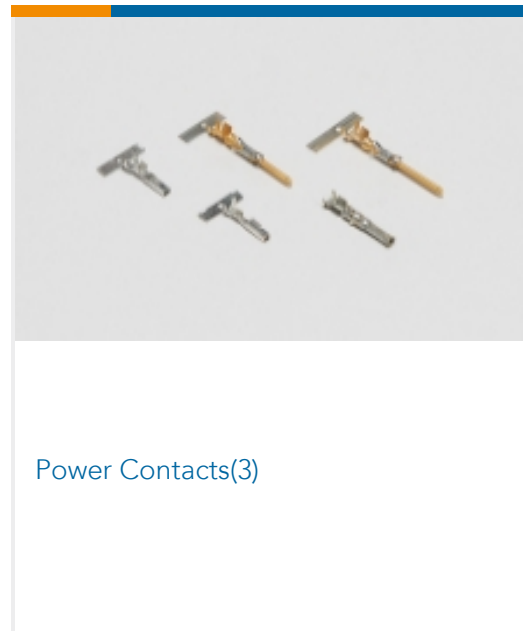

Power Contacts(3)



Rectangular Power Connectors(699)

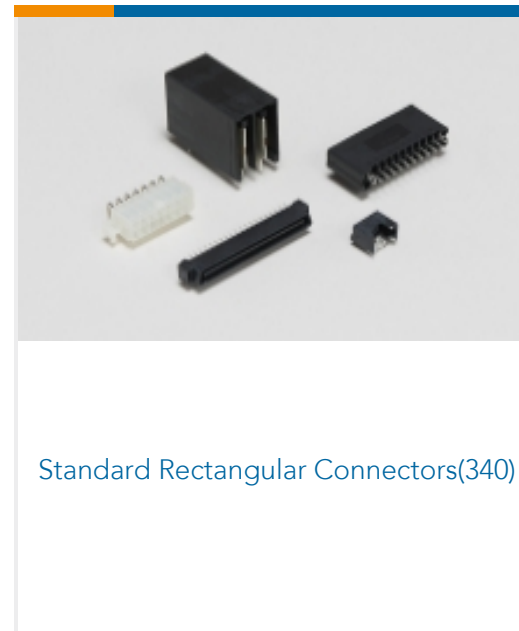

Standard Rectangular Connectors(340)

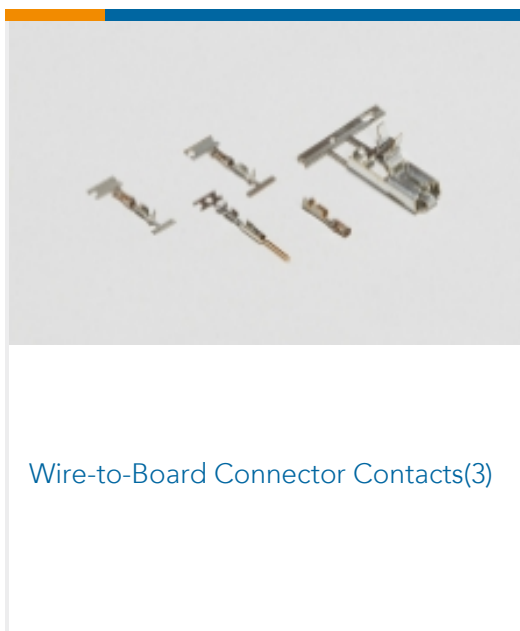

Wire-to-Board Connector Contacts(3)

Customers Also Bought



TE Part #52942-1
TERMINAL,PIDG SPR SPD 12-10 8



TE Part #350922-6
PIN, MATE-N-LOK, UMNL



TE Part #770210-1
UMNL GRND PIN PTPBR

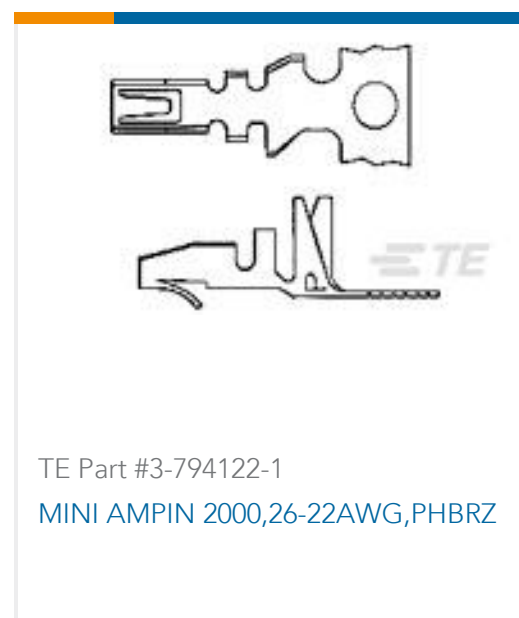

TE Part #3-794122-1
MINI AMPIN 2000,26-22AWG,PHBRZ

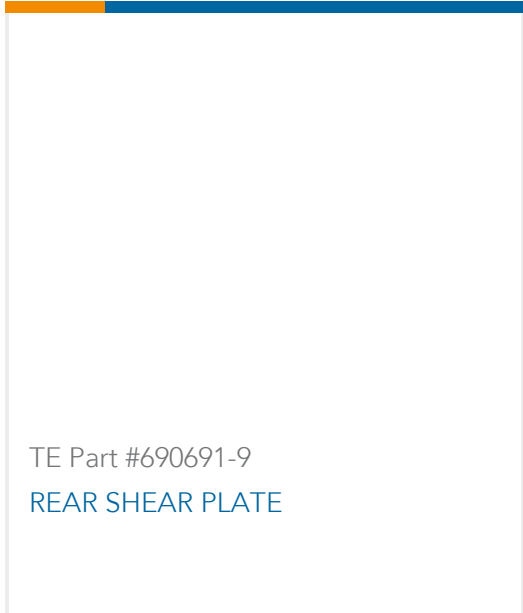

Documents

Product Drawings

[13P MTA156 CONN ASSY 18AWG ORA](#)

English

CAD Files

[3D PDF](#)

3D

Customer View Model

[ENG_CVM_CVM_4-640426-3_K.2d_dxf.zip](#)

English

Customer View Model

[ENG_CVM_CVM_4-640426-3_K.3d_igs.zip](#)

English

Customer View Model

[ENG_CVM_CVM_4-640426-3_K.3d_stp.zip](#)

English

By downloading the CAD file I accept and agree to the [Terms and Conditions](#) of use.

Product Specifications

[Product Specification](#)

English

Product Environmental Compliance

[TE Material Declaration](#)

English

Agency Approvals

[CSA Certificate](#)

4-640426-3

Rectangular Power Connectors, Connector Assembly, Receptacle, Wire-to-Board, 13
Position, 3.96 mm [.156 in] Centerline, Wire & Cable, MTA 156



English