

LOC	DIST	REVISIONS / REVISIONI			
P	LTR REV	DESCRIPTION / DESCRIZIONE	DATE DATA	DWN DIS.	APVD APP.
	A	FIRST ISSUE EC ET00-0065-99(WAS 96-51240)	MAR1999	A.M.	O.C.
	AI	RELEASED FOR PRODUCTION (ET00-0190-99)	06JUL1999	G.S.	O.C.
	B	ADDED LOCKING DEVICE (ECR-06-028677)	11DEC2006	M.P.	O.C.

SECTION A-A
(SEZIONE A-A)

OVERALL DIM. WITH SEC. LOCK OPENED
(INGOMBRO CON AGGANCIO SECONDARIO APERTO)

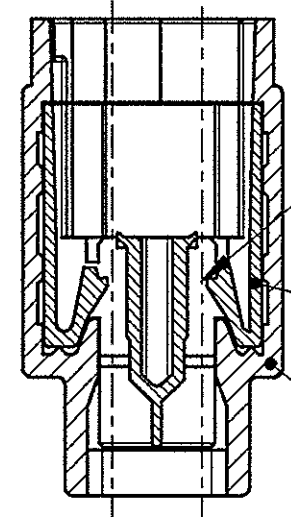
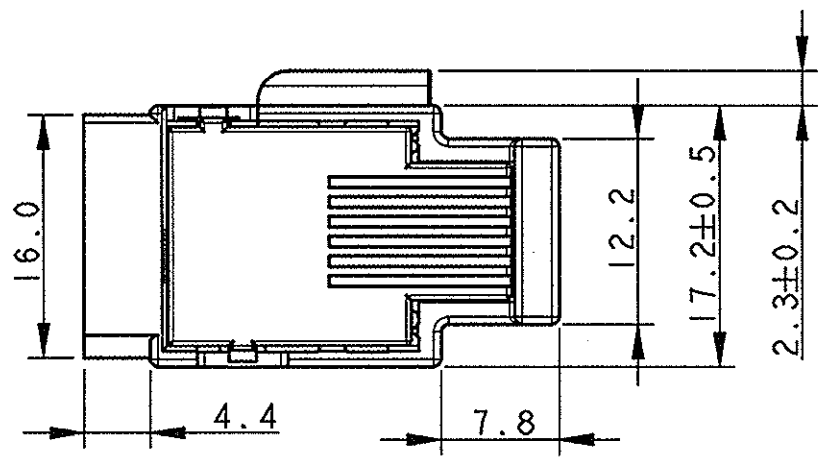

20 CAV. FOR NEW GENERATION MULTILOCK TAB CONTACT P/N 284080-1, 284107-1 AND 284108-1.
 (20 CAV. PER CONTATTI MASCHI NUOVA GENERAZIONE MULTILOCK P/N 284080-1, 284107-1 E 284108-1.)

OVERALL DIM. WITH SEC. LOCK CLOSED
(INGOMBRO CON AGGANCIO SECONDARIO CHIUSO)

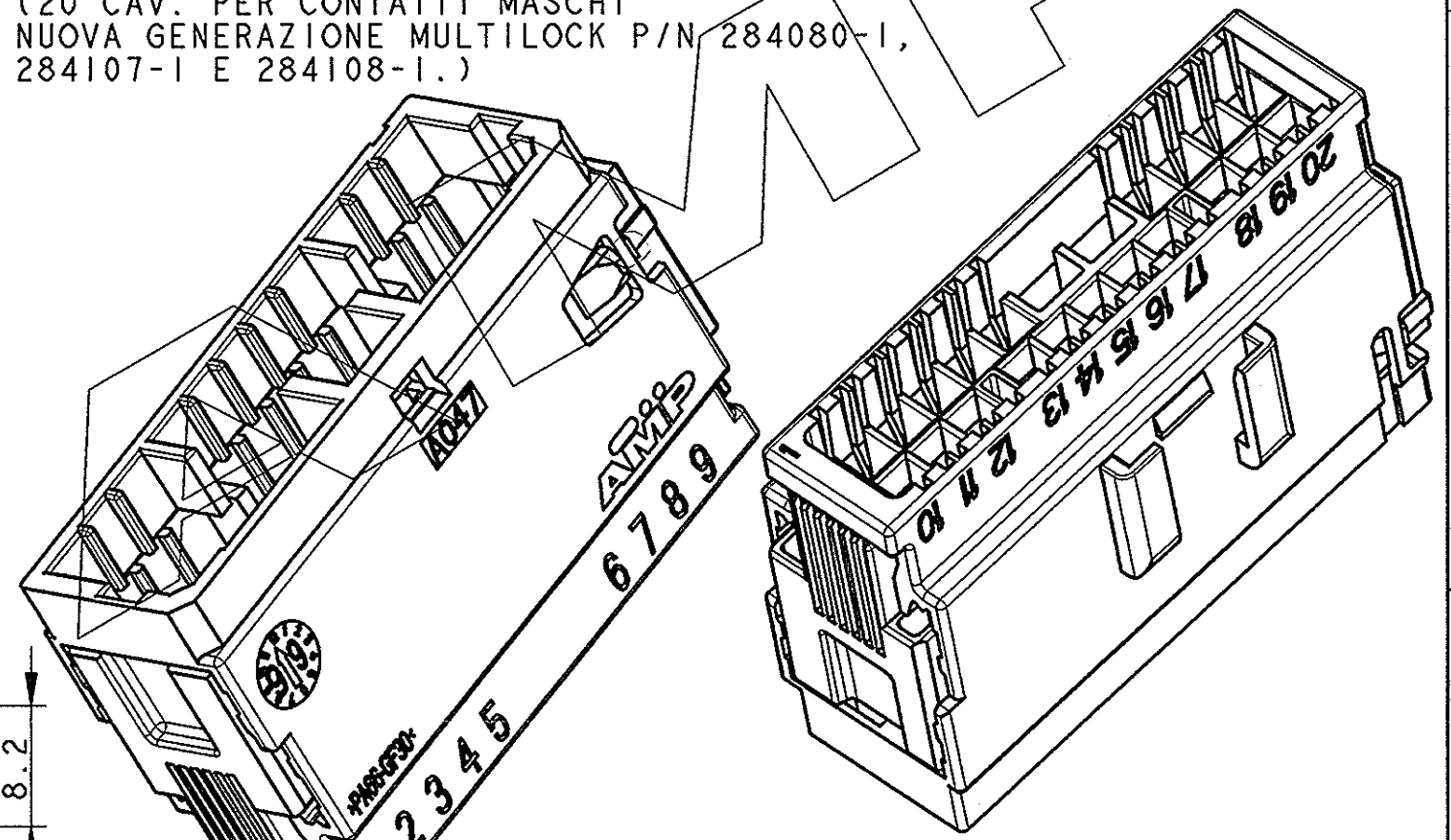
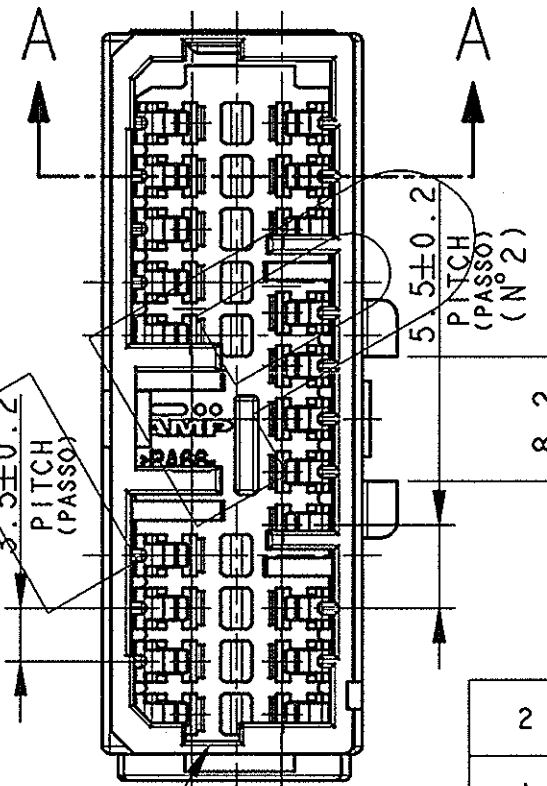
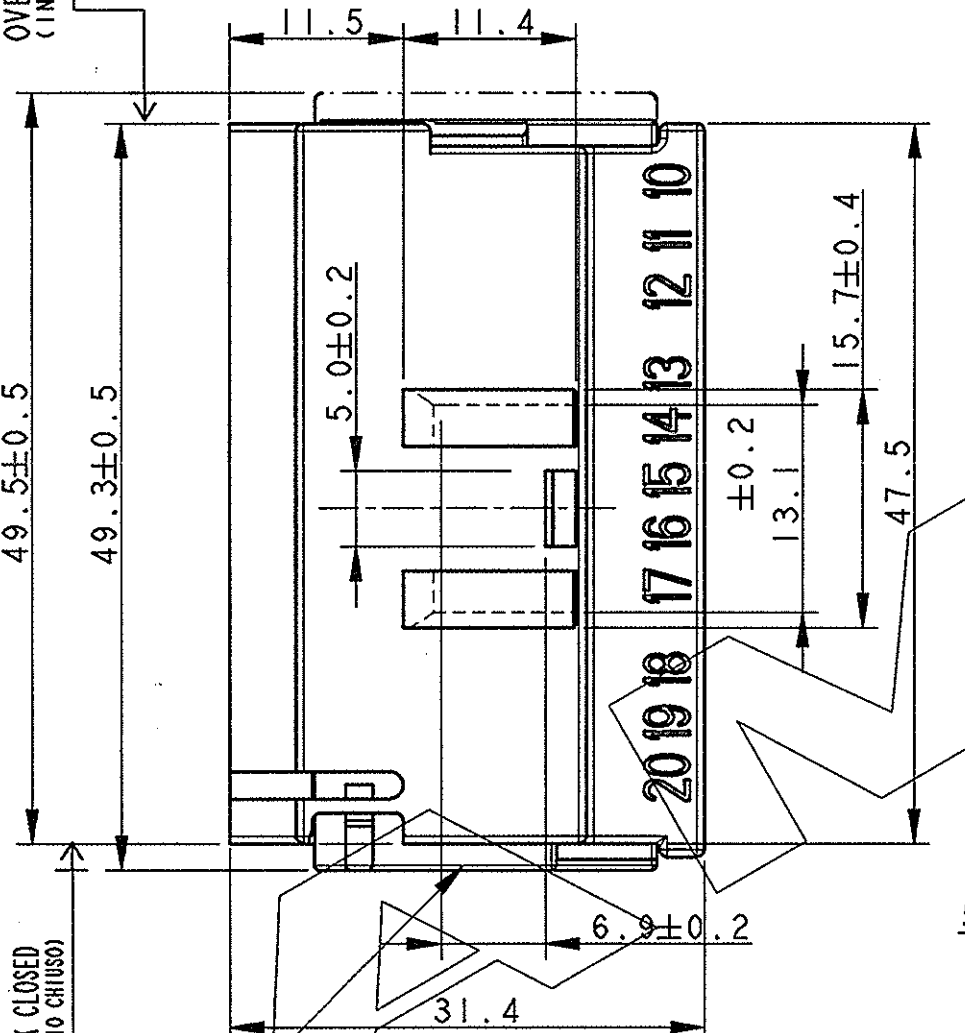

P/N 282994-2 AS SHOWN
(P/N 282994-2 COME MOSTRATO)

ITEM	DESCRIPTION (DESCRIZIONE)	FINISH/COLOUR (FINITURA/COLORE)	MATERIAL (MATERIALE)	PART NUMBER (NUMERO)
2	RECEPTACLE HOUSING (BLOCC. PORTA FEMMINE)	SEE SHEET 2 VED. FOGLIO 2	PA 66 G.F.	SEE SHEET 2 VED. FOGLIO 2
1	SEC. LOCKING DEVICE (AGGANCIO SECONDARIO)	SEE SHEET 2 VED. FOGLIO 2	PA 66 G.F.	SEE SHEET 2 VED. FOGLIO 2

FOR POLARIZATION DETAILS AND COUNTERPARTS P/N'S SEE SHEET 2
 (PER DETTAGLIO POLARIZZAZIONI E P/N'S CONTROPARTI VEDERE FOGLIO 2)

SUPPLIED WITH SEC. LOCKING DEVICE ON PRE-ASSEMBLED POSITION
 (FORNITO CON IL DISPOSITIVO DI AGGANCIO SECONDARIO IN POSIZIONE PRE-ASSEMBLATO)

THIS DRAWING IS A CONTROLLED DOCUMENT FOR AMP INCORPORATED. IT IS SUBJECT TO CHANGE AND THE CONTROLLING ENGINEERING ORGANIZATION SHOULD BE CONTACTED FOR THE LATEST REVISION. / QUESTO DISEGNO E' UN DOCUMENTO DI PROPRIETA' E RESPONSABILITA' DELL'AMP ITALIA S.P.A. SOGGETTO A VARIAZIONI. PER OTTENERE L'ULTIMA REVISIONE DEL DISEGNO CONTATTARE AMP ITALIA S.P.A.		DWN /DIS. 4-MAR-99 ANDREA MARANGON CHK /CONT. 4-MAR-99 OSCARE CANUTO APVD /APP. 4-MAR-99 ALESSANDRO GENTA		AMP ITALIA SpA C.so F.lli Cervi 15 COLLEGNO (TO)	
DIMENSIONS: DIMENSIONI: mm TOLERANCES UNLESS OTHERWISE SPECIFIED: TOLLERANZE: SE NON DIVERSAMENTE SPECIFICATO 0 PLC /DEC ±0.3 1 PLC /DEC ±0.3 2 PLC /DEC ±0.3 3 PLC /DEC ± 4 PLC /DEC ± ANGLES /ANGOLI #2		PRODUCT SPEC SPEC DI PRODOTTO 108-20175 APPLICATION SPEC SPEC DI APPLICAZIONE 114-20095		NAME: 20 POS. NEW GENERATION TAB CONNECTOR for trucks SIZE: A3 CAGE CODE: 00779 DRAWING NO: 282994	
MATERIAL: SEE TABLE (VEDERE TABELLA) FINISH: FINITURA -		WEIGHT: 13.0 g PESO		CUSTOMER DRAWING FOR REFERENCE ONLY / DISEGNO PER CLIENTE SOLO PER RIFERIMENTO SCALE: 2:1 SHEET: 1 OF 2 REV: B	

THIS DRAWING IS UNPUBLISHED. QUESTO DISEGNO NON DEVE ESSERE DIVULGATO O RIPRODOTTO. RELEASED FOR PUBLICATION E' CONSENTITA LA DIVULGAZIONE. ALL RIGHTS RESERVED. TUTTI I DIRITTI SONO RISERVATI. BY AMP INCORPORATED.

LOC 1 DIST -

REVISIONS REVISIONI					
P	LTR REV	DESCRIPTION DESCRIZIONE	DATE DATA	DWN DIS.	APVD APP.
-	-	SEE SHEETS HIE ET (VEDERE FOGLIO 1)	-	-	-

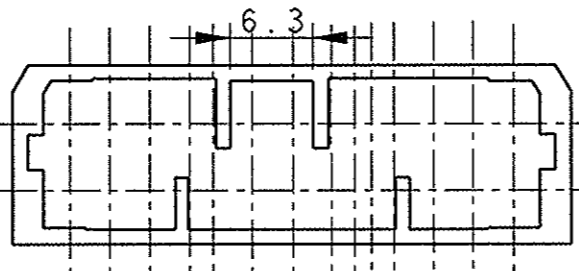
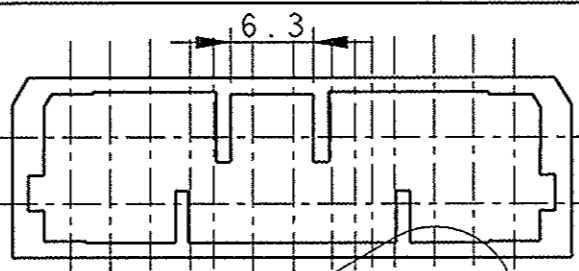
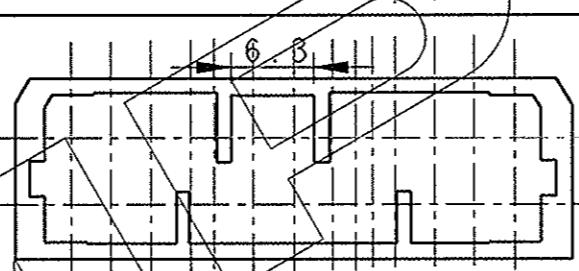
P/N	ITEM 1-2 COLOUR (COLORE)	GRAPHIC REPRESENTATION MATING FACE (RAPPRESENTAZIONE GRAFICA LATO ACCOPPIAMENTO)	P/N FREE HANGING COUNTERPART (CONTROPARTE VOLANTE)
282994-2	BLACK (NERO)		282991-2
282994-3	BLUE (BLU)		282991-3
282994-4	GREY (GRIGIO)		282991-4

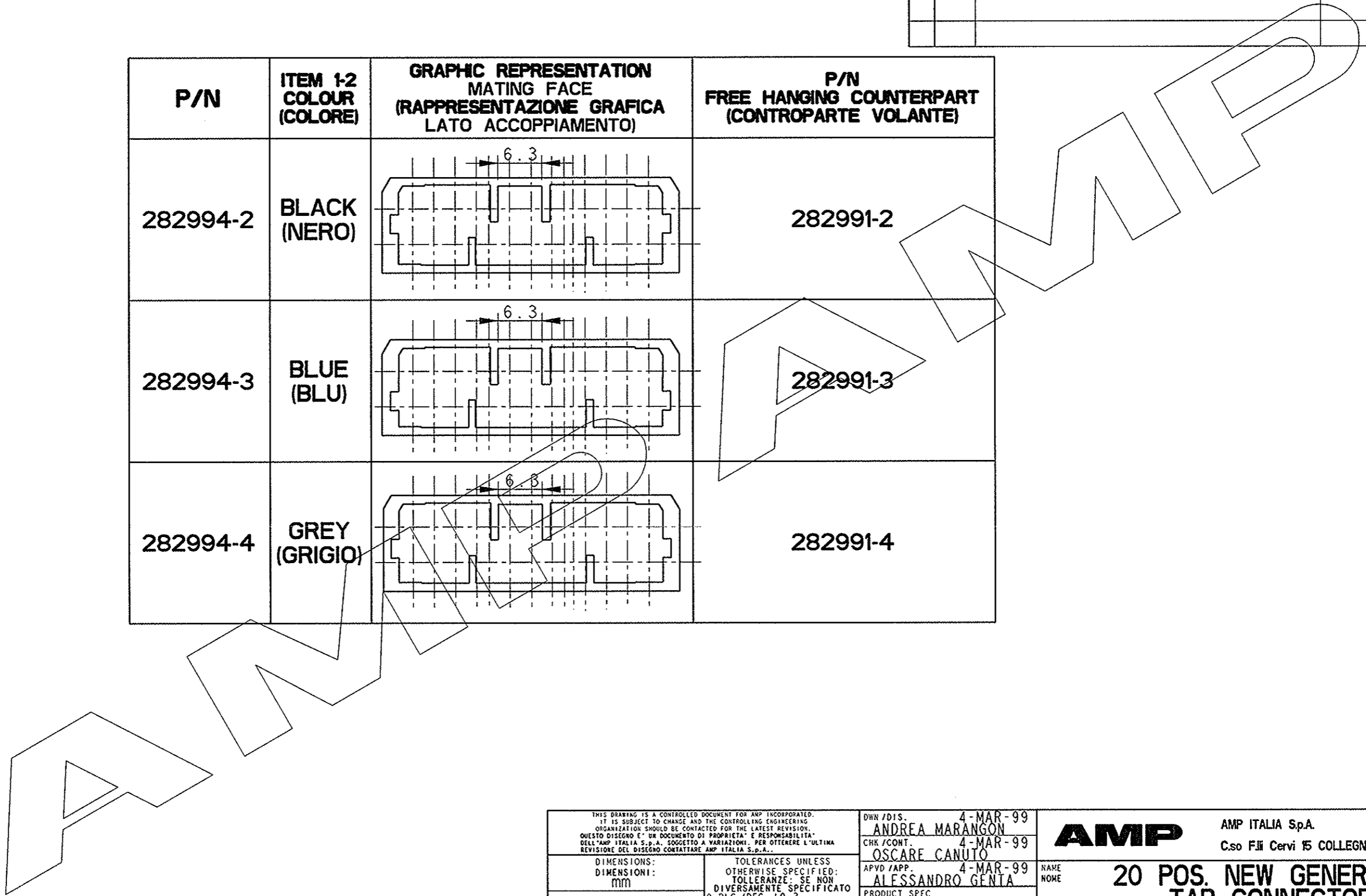

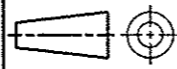
<small>THIS DRAWING IS A CONTROLLED DOCUMENT FOR AMP INCORPORATED. IT IS SUBJECT TO CHANGE AND THE CONTROLLING ENGINEERING ORGANIZATION SHOULD BE CONTACTED FOR THE LATEST REVISION. QUESTO DISEGNO E' UN DOCUMENTO DI PROPRIETA' E RESPONSABILITA' DELL'AMP ITALIA S.p.A. SOGGETTO A VARIAZIONI. PER OTTENERE L'ULTIMA REVISIONE DEL DISEGNO CONTATTARE AMP ITALIA S.p.A.</small>		DWN /DIS. 4-MAR-99 ANDREA MARANGON CHK /CONT. 4-MAR-99 OSCAR CANUTO APVD /APP. 4-MAR-99 ALESSANDRO GENTA		AMP AMP ITALIA Sp.A. C.so F.lli Cervi 15 COLLEGNO (TO)	
DIMENSIONS: DIMENSIONI: mm 		TOLERANCES UNLESS OTHERWISE SPECIFIED: TOLLERANZE: SE NON DIVERSAMENTE SPECIFICATO 0 PLC /DEC ±0.3 1 PLC /DEC ±0.3 2 PLC /DEC ±0.3 3 PLC /DEC ± 4 PLC /DEC ±- ANGLES /ANGOLI ±2		NAME NONE 20 POS. NEW GENERATION TAB CONNECTOR for trucks	
MATERIAL MATERIALE SEE SHEET (VEDERE FOGLIO 1)		FINISH FINITURA -		SIZE A3 CAGE CODE 00779 DRAWING NO. NUMERO C= 282994	
CUSTOMER DRAWING FOR REFERENCE ONLY		DISEGNO PER CLIENTE SOLO PER RIFERIMENTO		SCALE SCALA 2:1 SHEET FOGLIO 2 OF DI 2 REV B	