

CDBV120-G Thru. CDBV140-G

Forward current: 1.0A
Reverse voltage: 20 to 40V
RoHS Device

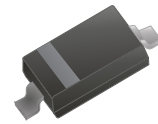

Features

- For use in low voltage, high frequency inverters.
- Free wheeling, and polarity protection applications.

Mechanical Data

- Case: SOD-323, molded plastic.
- Terminals: Solderable per MIL-STD-750, method 2026.
- Polarity: Indicated by cathode end.

Circuit Diagram

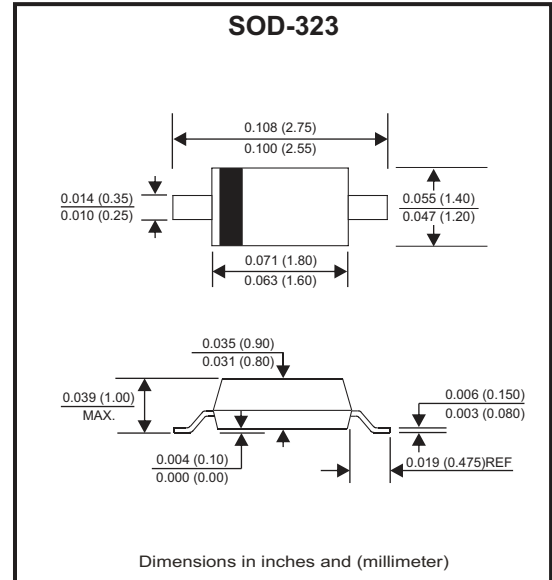

Maximum Ratings (At Ta=25°C, unless otherwise noted)

Parameter	Symbol	CDBV120-G	CDBV130-G	CDBV140-G	Unit
Non-repetitive peak reverse voltage	V_{RM}	20	30	40	V
Peak repetitive peak reverse voltage	V_{RRM}	20	30	40	V
Working peak reverse voltage	V_{RWM}				
DC blocking voltage	V_R				
RMS reverse voltage	$V_{R(RMS)}$	14	21	28	V
Average rectified output current	I_O	1			A
Non-repetitive peak forward surge current @ t=8.3ms	I_{FSM}	9			A
Repetitive peak forward current	I_{FRM}	1.5			A
Power dissipation	P_D	250			mW
Thermal resistance, junction to ambient	$R_{\theta JA}$	400			°C/W
Junction temperature range	T_J	-40 ~ +125			°C
Storage temperature range	T_{STG}	-55 ~ +150			°C

Electrical Characteristics (At Ta=25°C, unless otherwise noted)

Parameter	Conditions	Symbol	Min.	Max.	Unit
Reverse breakdown voltage	CDBV120-G CDBV130-G CDBV140-G $I_R = 1\text{mA}$	$V_{(BR)}$	20 30 40		V
Reverse voltage leakage current	CDBV120-G CDBV130-G CDBV140-G $V_R = 20\text{V}$ $V_R = 30\text{V}$ $V_R = 40\text{V}$	I_R		1	mA
Forward voltage	CDBV120-G CDBV130-G CDBV140-G $I_F = 1\text{A}$	V_F		0.45 0.55 0.60	V
	CDBV120-G CDBV130-G CDBV140-G $I_F = 3\text{A}$			0.75 0.875 0.90	V
Diode capacitance	$V_R = 4\text{V}, f = 1\text{MHz}$	C_D		120	pF

Company reserves the right to improve product design, functions and reliability without notice.

REV:D

TYPICAL RATING AND CHARACTERISTIC CURVES (CDBV120-G thru.CDBV140-G)

Fig.1- Power Derating Curve

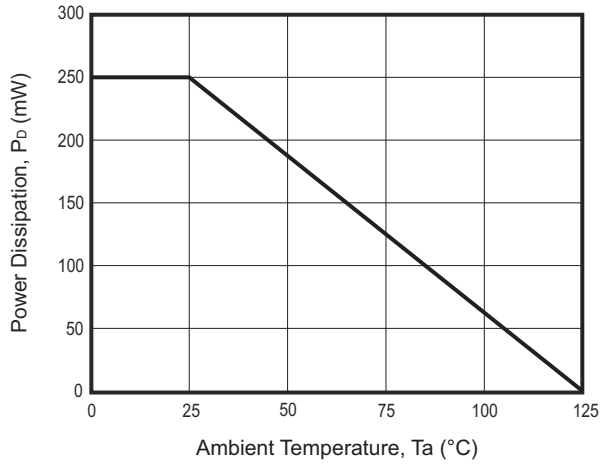
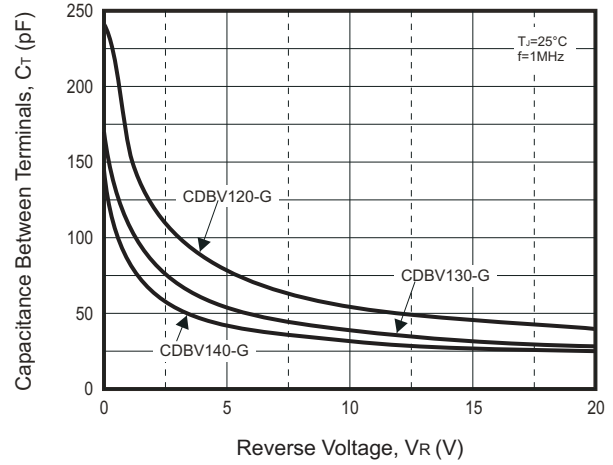

Fig.2- Capacitance Characteristics



TYPICAL RATING AND CHARACTERISTIC CURVES (CDBV120-G)

Fig.3 - Forward Characteristics

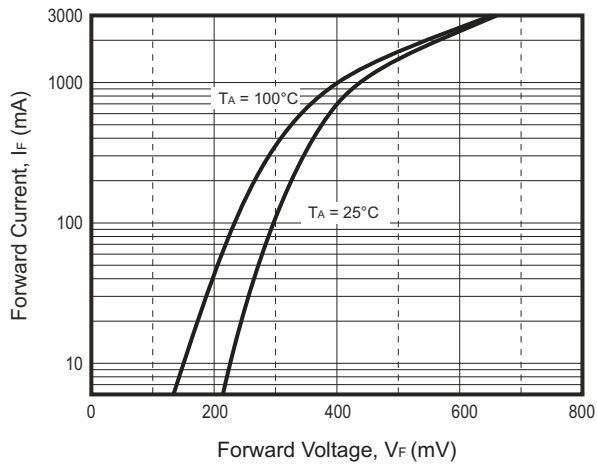
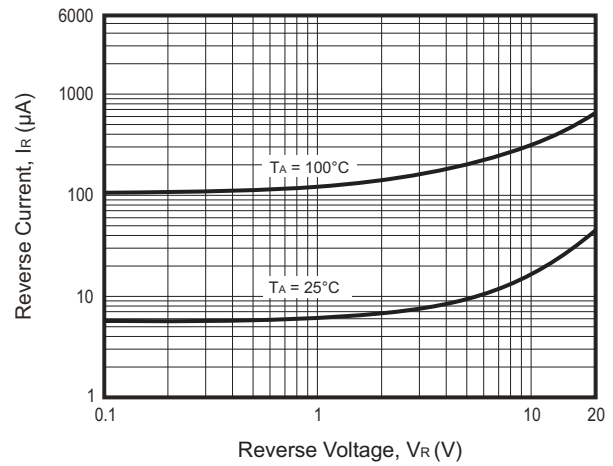

Fig.4 - Reverse Characteristics



TYPICAL RATING AND CHARACTERISTIC CURVES (CDBV130-G)

Fig.5 - Forward Characteristics

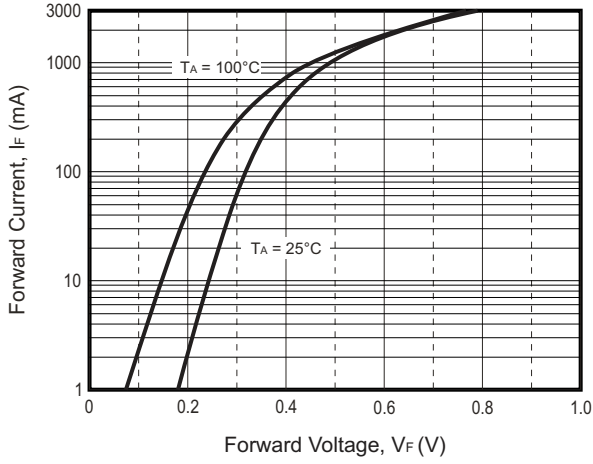
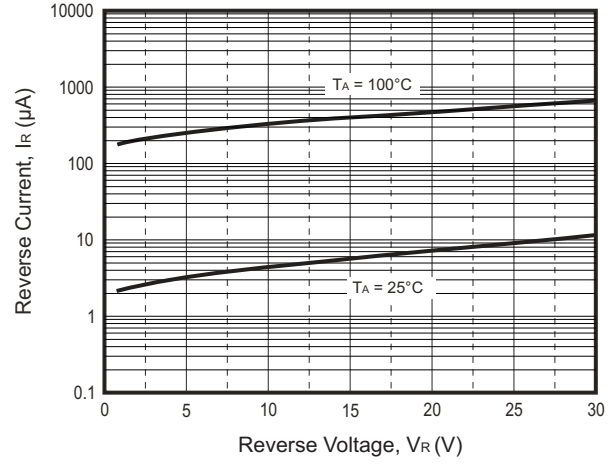

Fig.6 - Reverse Characteristics



TYPICAL RATING AND CHARACTERISTIC CURVES (CDBV140-G)

Fig.7 - Forward Characteristics

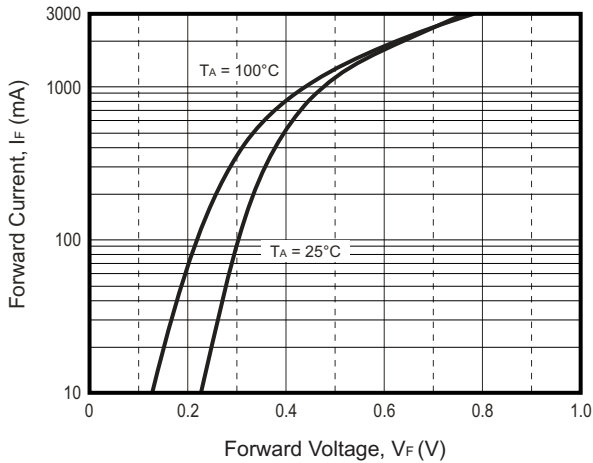
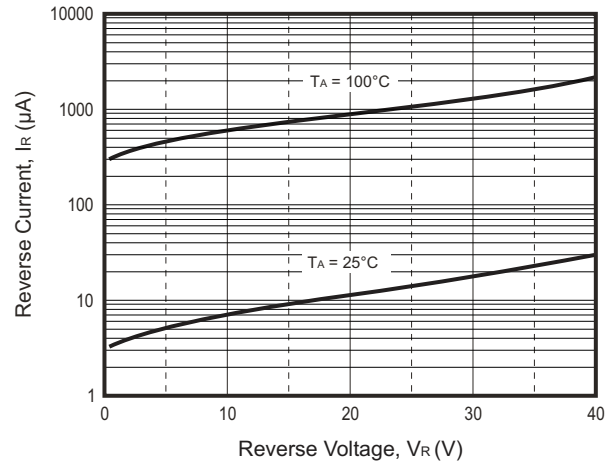
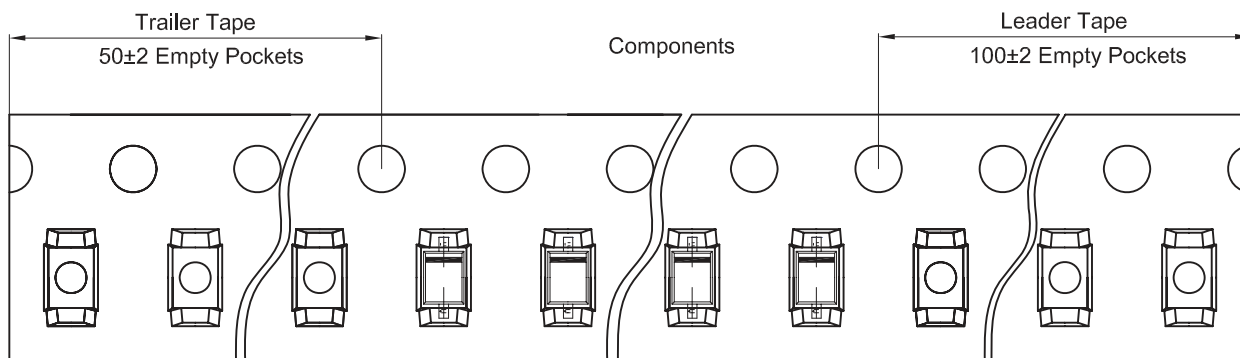
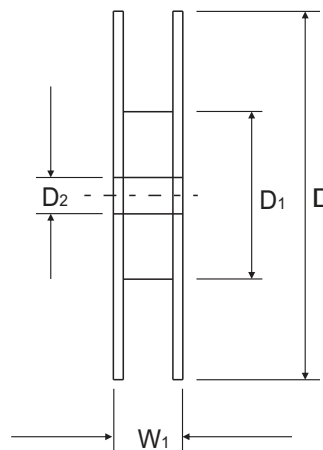
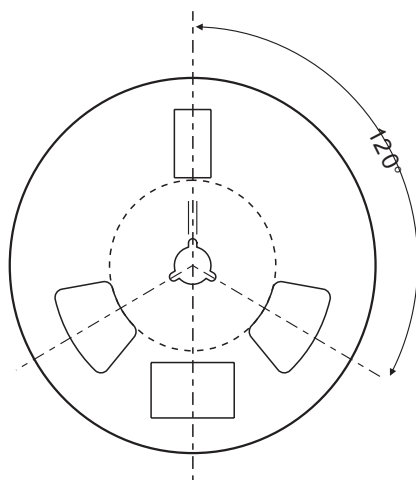
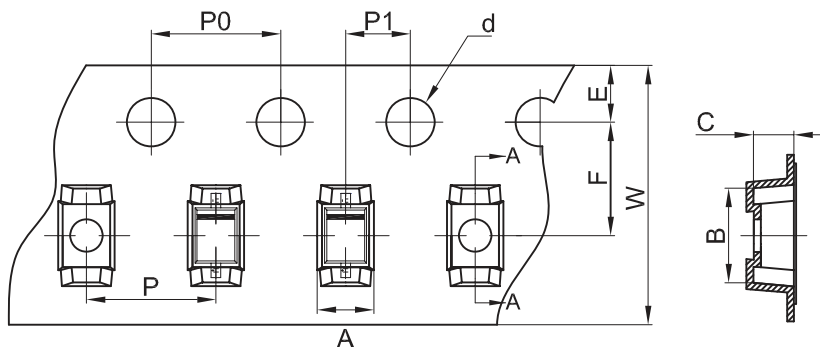

Fig.8 - Reverse Characteristics



Reel Taping Specification



SOD-323	SYMBOL	A	B	C	d	D	D1	D2
	(mm)	1.48 ± 0.05	3.30 ± 0.05	1.25 ± 0.05	1.50 ± 0.10	178 ± 2.00	54.40 ± 1.00	13.00 ± 1.00
	(inch)	0.058 ± 0.002	0.130 ± 0.002	0.049 ± 0.002	0.059 ± 0.004	7.008 ± 0.079	2.142 ± 0.039	0.512 ± 0.039

SOD-323	SYMBOL	E	F	P	P0	P1	W	W1
	(mm)	1.75 ± 0.10	3.50 ± 0.10	4.00 ± 0.10	4.00 ± 0.10	2.00 ± 0.10	8.00 ± 0.30 / - 0.10	12.30 ± 1.00
	(inch)	0.069 ± 0.004	0.138 ± 0.004	0.158 ± 0.004	0.158 ± 0.004	0.079 ± 0.004	0.315 ± 0.012 / - 0.004	0.484 ± 0.039

Company reserves the right to improve product design, functions and reliability without notice.

REV:D

Marking Code

Part Number	Marking Code
CDBV120-G	SJ
CDBV130-G	SK
CDBV140-G	SL



XX = Product type marking code

█ = The marking bar indicates the cathode.

Suggested PAD Layout

SIZE	SOD-323	
	(mm)	(inch)
A	2.15	0.085
B	0.70	0.028
C	0.70	0.028

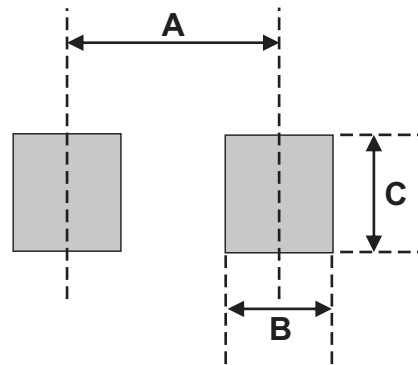

Note:

- 1.General tolerance: $\pm 0.05\text{mm}$.
- 2.The pad layout is for reference purposes only.

Standard Packaging

Case Type	REEL PACK	
	REEL (pcs)	Reel Size (inch)
SOD-323	3,000	7