



Winbond Clock Generator
W83195WG-382
W83195CG-382
For ATI K8 Chipset

Date: Feb/27/2006 Revision: 0.6

W83195WG-382/W83195CG-382



STEPLESS FOR ATI K8 CLOCK GENERATOR

W83195WG-382/W83195CG-382 Data Sheet Revision History

	PAGES	DATES	VERSION	WEB VERSION	MAIN CONTENTS
1	n.a.	01/20/2006	0.5	n.a.	All of the versions before 0.50 are for internal use.
2	15	02/27/2006	0.6	n.a.	Add HTT66 asynchronous mode.
3					
4					
5					
6					
7					
8					
9					
10					

Please note that all data and specifications are subject to change without notice. All the trademarks of products and companies mentioned in this data sheet belong to their respective owners.

LIFE SUPPORT APPLICATIONS

These products are not designed for use in life support appliances, devices, or systems where malfunction of these products can reasonably be expected to result in personal injury. Winbond customers using or selling these products for use in such applications do so at their own risk and agree to fully indemnify Winbond for any damages resulting from such improper use or sales.

W83195WG-382/W83195CG-382



STEPLESS FOR ATI K8 CLOCK GENERATOR

Table of Content

1.	GENERAL DESCRIPTION	1
2.	PRODUCT FEATURES	1
3.	PIN CONFIGURATION	2
4.	BLOCK DIAGRAM	2
5.	PIN DESCRIPTION.....	3
6.	FREQUENCY SELECTION BY HARDWARE OR SOFTWARE	5
7.	I ² C CONTROL AND STATUS REGISTERS	6
7.1	Register 0: (Default : 00h)	6
7.2	Register 1: (Default : XXh)	6
7.3	Register 2: (Default : 03h)	7
7.4	Register 3: (Default : 03h)	7
7.5	Register 4: (Default : FEh)	8
7.6	Register 5: (Default : 02h)	8
7.7	Register 6: (Default : FFh)	9
7.8	Register 7: Winbond Chip ID – Project Code Register (Default : 06h)	10
7.9	Register 8: (Default :D0h)	10
7.10	Register 9: (Default : 7Ah)	10
7.11	Register 10: Reserved (Default : 3Bh)	11
7.12	Register 11: (Default : 0Eh)	11
7.13	Register 12: (Default : XXh)	11
	Table-2 CPU, SRC, PCI divider ratio selection Table	11
7.14	Register 13: (Default : 3Fh)	12
7.15	Register 14: (Default : D0h)	12
7.16	Register 15: (Default : 5Ch)	12
7.17	Register 16: (Default : 24h)	13
7.18	Register 17: Reserved (Default : 07h)	14
7.19	Register 18: Reserved (Default : 7Ah)	14
7.20	Register 19: (Default : 04h)	14
7.21	Register 20: (Default : 88h)	15
7.22	Register 21: (Default : ECh)	15
	Table3: SRC & ATIG Frequency Selection Table	16
8.	ACCESS INTERFACE	17
8.1	Block Write protocol	17

W83195WG-382/W83195CG-382



STEPLESS FOR ATI K8 CLOCK GENERATOR

8.2	Block Read protocol	17
8.3	Byte Write protocol	17
8.4	Byte Read protocol.....	17
9.	SPECIFICATIONS	18
9.1	ABSOLUTE MAXIMUM RATINGS	18
9.2	General Operating Characteristics	18
9.3	Skew Group timing clock.....	18
9.4	CPU 0.7V Electrical Characteristics	19
9.5	SRC 0.7V Electrical Characteristics	19
9.6	ATIG 0.7V Electrical Characteristics.....	19
9.7	PCI Electrical Characteristics	20
9.8	USB Electrical Characteristics	20
9.9	REF Electrical Characteristics	20
10.	ORDERING INFORMATION.....	21
11.	HOW TO READ THE TOP MARKING.....	21
12.	PACKAGE DRAWING AND DIMENSIONS.....	22

W83195WG-382/W83195CG-382



STEPLESS FOR ATI K8 CLOCK GENERATOR

1. GENERAL DESCRIPTION

The W83195WG-382/W83195CG-382 is a Clock Synthesizer for ATI K8 serial chipsets. W83195WG-382/ W83195CG-382 provides all clocks required for the high-speed microprocessor and provides step-less frequency programming and 32 different frequencies of CPU, PCI, and SRC clocks setting, all clocks are externally selectable with smooth transitions.

The W83195WG-382/ W83195CG-382 has watchdog timer and reset output pin to support auto-reset when systems hanging caused by improper frequency setting. It also support CPU TURBO function when system has heavy loading.

The W83195WG-382/W83195CG-382 provides I²C serial bus interface to program the registers to enable or disable each clock outputs and provides programmable S.S.T. scale to reduce EMI.

The W83195WG-382/W83195CG-382 accepts a 14.318 MHz reference crystal as its input and runs on a 3.3V supply.

2. PRODUCT FEATURES

- 2 pair push-pull Differential clock outputs for CPU.
- 6 pair current-mode Differential clock outputs for SRC.
- 2 pair current-mode Differential clock outputs for ATIG programmable.
- 1 PCI clock output.
- 1 48 MHz clock output for USB.
- 3 14.318MHz REF clock outputs.
- 1 HTT 66MHz clock output.
- Smooth frequency switch with selections from 100 to 400MHz.
- Step-less frequency programming.
- CPU TURBO function support.
- I²C 2-wire serial interface and support byte read/write and block read/write.
- Programmable S.S.T. scale to reduce EMI in M/N mode.
- Programmable registers to enable/disable each output and select modes.
- Programmable clock outputs slew rate control and skew control.
- Watch Dog Timer and RESET# output pins
- 56 pin TSSOP/SSOP package.

W83195WG-382/W83195CG-382



STEPLESS FOR ATI K8 CLOCK GENERATOR

3. PIN CONFIGURATION

XIN	1	56	VDDREF
XOUT	2	55	GND
VDD48	3	54	⁵ FSA/REF0
*TURBO_SEL/USB_48	4	53	⁵ FSB/REF1
GND	5	52	⁵ FSC/REF2
*PD#	6	51	VDDPCI
SCLK	7	50	PCICLK0
SDATA	8	49	GND
RESET#	9	48	VDDHTT
⁴ CLKREQA#	10	47	HTTCLK0
⁴ TURBO/ ⁴ CLKREQB#	11	46	GND
SRCT7	12	45	CPUCLK8T0
SRCC7	13	44	CPUCLK8C0
VDDSRC	14	43	VDDCPU
GND	15	42	GND
SRCT6	16	41	CPUCLK8T1
SRCC6	17	40	CPUCLK8C1
SRCT5	18	39	VDDA
SRCC5	19	38	GNDA
GND	20	37	IREF
VDDSRC	21	36	GND
SRCT4	22	35	VDDSRC
SRCC4	23	34	SRCT0
SRCT3	24	33	SRCC0
SRCC3	25	32	VDDATI
GND	26	31	GND
ATIGT1	27	30	ATIGT0
ATIGC1	28	29	ATIGC0

#: Active low
*: Internal pull up resistor 120K to VDD
&: Internal Pull-down resistor 120K to GND

4. BLOCK DIAGRAM

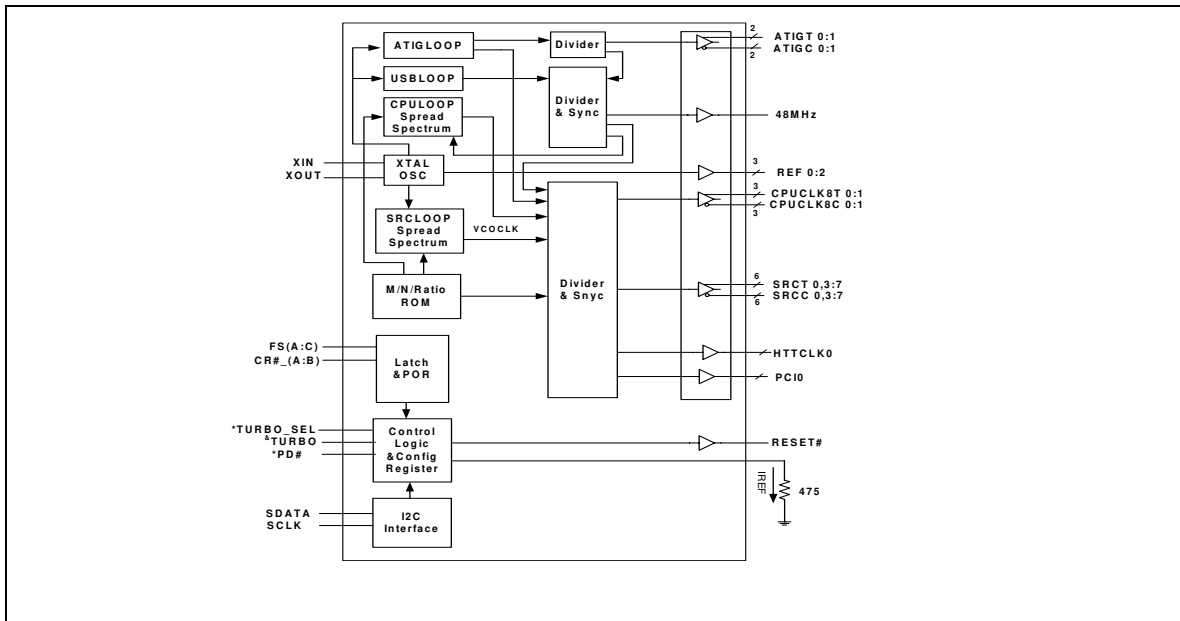

W83195WG-382/W83195CG-382



STEPLESS FOR ATI K8 CLOCK GENERATOR

5. PIN DESCRIPTION

PIN	PIN NAME	TYPE	DESCRIPTION
1	XIN	IN	Crystal output at 14.318MHz nominally with internal loading capacitors (18pF).
2	XOUT	OUT	Crystal input with internal loading capacitors (18pF) and feedback resistors.
3	VDD48	PWR	Power supply for USB_48
4	*TURBO_SEL/USB_48	I/O	Real time input pin to change frequency to a pre-programmed. 3.3V USB 48Mhz clock output.
5	GND	PWR	Ground pin
6	*PD#	IN	Power down mode
7	SCLK	IN	Serial clock of I ² C 2-wire control interface.
8	SDATA	I/O	Serial data of I ² C 2-wire control interface.
9	RESET#	OUT	System reset signal when the watchdog is time out.
10	&CLKREQA#	IN	Dynamic output control 0 = active, 1 = inactive
11	&TURBO/&CLKREQB#	IN	Turbo function control. Dynamic output control 0 = active, 1 = inactive
12	SRCT7	OUT	0.7V current mode differential clock output for SRC
13	SRCC7	OUT	0.7V current mode differential clock output for SRC
14	VDDSRC	PWR	Power supply for SRC
15	GND	PWR	Ground pin
16	SRCT6	OUT	0.7V current mode differential clock output for SRC
17	SRCC6	OUT	0.7V current mode differential clock output for SRC
18	SRCT5	OUT	0.7V current mode differential clock output for SRC
19	SRCC5	OUT	0.7V current mode differential clock output for SRC
20	GND	PWR	Ground pin
21	VDDSRC	PWR	Power supply for SRC
22	SRCT4	OUT	0.7V current mode differential clock output for SRC
23	SRCC4	OUT	0.7V current mode differential clock output for SRC
24	SRCT3	OUT	0.7V current mode differential clock output for SRC
25	SRCC3	OUT	0.7V current mode differential clock output for SRC
26	GND	PWR	Ground pin
27	ATIGT1	OUT	0.7V current mode differential clock output for ATIG
28	ATIGC1	OUT	0.7V current mode differential clock output for ATIG

W83195WG-382/W83195CG-382



STEPLESS FOR ATI K8 CLOCK GENERATOR

29	ATIGC0	OUT	0.7V current mode differential clock output for ATIG
30	ATIGT0	OUT	0.7V current mode differential clock output for ATIG
31	GND	PWR	Ground pin
32	VDDATIG	PWR	Power supply for ATIG
33	SRCC0	OUT	0.7V current mode differential clock output for SRC
34	SRCT0	OUT	0.7V current mode differential clock output for SRC
35	VDDSRC	PWR	Power supply for SRC
36	GND	PWR	Ground pin
37	IREF	OUT	Deciding the reference current for the differential pairs. The pin was connected to the precision resistor tied to ground to decide the appropriate current; 475 ohm is the standard value.
38	GND A	PWR	Ground pin for PLL core.
39	VDDA	PWR	3.3V power supply for PLL core.
40	CPUCLK8C1	OUT	3.3V Push Pull differential clock output for AMD K8
41	CPUCLK8T1	OUT	3.3V Push Pull differential clock output for AMD K8
42	GND	PWR	Ground pin
43	VDDCPU	PWR	Power supply for CPU
44	CPUCLK8C0	OUT	3.3V Push Pull differential clock output for AMD K8
45	CPUCLK8T0	OUT	3.3V Push Pull differential clock output for AMD K8
46	GND	PWR	Ground pin
47	HTTCLK0	OUT	3.3V HTT clock output.
48	VDDHTT	PWR	Power supply for HTTCLK
49	GND	PWR	Ground pin
50	PCICLK0	OUT	3.3V PCI clock output.
51	VDDPCI	PWR	Power supply for PCI
52	&FSC/REF2	I/O	FSC CPU frequency select/3.3V REF 14.318Mhz clock output.
53	&FSB/REF1	I/O	FSB CPU frequency select/3.3V REF 14.318Mhz clock output.
54	&FSA/REF0	I/O	FSA CPU frequency select/3.3V REF 14.318Mhz clock output.
55	GND	PWR	Ground pin
56	VDDREF	PWR	Power supply for REF

W83195WG-382/W83195CG-382



STEPLESS FOR ATI K8 CLOCK GENERATOR

6. FREQUENCY SELECTION BY HARDWARE OR SOFTWARE

This frequency table is used at power on latched FS [2:0] value or software programming at SSEL [4:0] (Register 0 bit 7 ~ 3). If FS [2:0] no any external circuit to modify power on status the Gray shading is Hardware default frequency.

BIT 7	BIT 6	BIT 5	BIT 4	BIT 3	CPU (MHZ)	SRC (MHZ)	PCI (MHZ)
FS4	FS3	FS2	FS1	FS0			
0	0	0	0	0	266.68	100.00	33.33
0	0	0	0	1	133.34	100.00	33.33
0	0	0	1	0	200.01	100.00	33.33
0	0	0	1	1	166.59	111.06	33.32
0	0	1	0	0	333.17	111.06	33.32
0	0	1	0	1	100.00	100.00	33.33
0	0	1	1	0	400.01	100.00	33.33
0	0	1	1	1	200.06	100.03	33.34
0	1	0	0	0	266.68	100.00	33.33
0	1	0	0	1	133.34	100.00	33.33
0	1	0	1	0	200.01	100.00	33.33
0	1	0	1	1	166.59	111.06	33.32
0	1	1	0	0	333.17	111.06	33.32
0	1	1	0	1	100.00	100.00	33.33
0	1	1	1	0	400.01	100.00	33.33
0	1	1	1	1	200.06	100.03	33.34
1	0	0	0	0	100.00	100.00	33.33
1	0	0	0	1	133.34	100.00	33.33
1	0	0	1	0	200.01	100.00	33.33
1	0	0	1	1	166.59	111.06	33.32
1	0	1	0	0	199.90	99.95	33.32
1	0	1	0	1	266.68	100.00	33.33
1	0	1	1	0	400.01	100.00	33.33
1	0	1	1	1	333.30	111.10	33.33
1	1	0	0	0	100.00	100.00	33.33
1	1	0	0	1	133.34	100.00	33.33
1	1	0	1	0	200.01	100.00	33.33
1	1	0	1	1	166.59	111.06	33.32
1	1	1	0	0	199.90	99.95	33.32
1	1	1	0	1	266.68	100.00	33.33
1	1	1	1	0	400.01	100.00	33.33
1	1	1	1	1	333.30	111.10	33.33

W83195WG-382/W83195CG-382



STEPLESS FOR ATI K8 CLOCK GENERATOR

7. I²C CONTROL AND STATUS REGISTERS

(The register No. is increased by 1 if use byte data read/write protocol)

7.1 Register 0: (Default : 00h)

BIT	AFFECTED PIN/ FUNCTION NAME(S)	PWD	AFFECTED PIN / FUNCTION DESCRIPTION	TYPE
7	SSEL<4>	0	Software frequency table selection through I ² C	R/W
6	SSEL<3>	0		
5	SSEL<2>	0		
4	SSEL<1>	0		
3	SSEL<0>	0		
2	EN_SSEL	0	Enable software table selection FS[4:0]. 0 = Hardware table setting (Jump mode). 1 = Software table setting through Bit7~3 . (Jumpleless mode)	R/W
1	SPSPEN	0	Enable spread spectrum mode under clock output. 0 = Spread Spectrum mode disable 1 = Spread Spectrum mode enable	R/W
0	EN_SAFE_FREQ	0	After watchdog timeout 0 = Reload the hardware FS [4:0] latched pins setting. 1 = Reload the desirable frequency table selection defined at Reg-5 Bit 4~0.	R/W

7.2 Register 1: (Default : XXh)

BIT	AFFECTED PIN/ FUNCTION NAME(S)	PWD	FUNCTION DESCRIPTION	TYPE
7	Reserved	1	Reserved	R/W
6	CPUEN<1>	1	CPUCLKT1/C1 output control 1: Enable 0: Disable	R/W
5	CPUEN<0>	1	CPUCLKT0/C0 output control 1: Enable 0: Disable	R/W
4	Reserved	X	Reserved	R
3	Reserved	X	Reserved	R
2	FS2_BACK	X	Power on latched value of FS2 pin. Default : 0	R
1	FS1_BACK	X	Power on latched value of FS1 pin. Default : 0	R
0	FS0_BACK	X	Power on latched value of FS0 pin. Default : 0	R

W83195WG-382/W83195CG-382



STEPLESS FOR ATI K8 CLOCK GENERATOR

7.3 Register 2: (Default : 03h)

BIT	AFFECTED PIN/ FUNCTION NAME(S)	PWD	FUNCTION DESCRIPTION	TYPE
7	CLREQA7#_Ctr	0	SRCCLK7 is controlled by the CLREQA# pin 1: Controllable 0: Uncontrollable	R/W
6	CLREQA6#_Ctr	0	SRCCLK6 is controlled by the CLREQA# pin 1: Controllable 0: Uncontrollable	R/W
5	CLREQA5#_Ctr	0	SRCCLK5 is controlled by the CLREQA# pin 1: Controllable 0: Uncontrollable	R/W
4	CLREQA4#_Ctr	0	SRCCLK4 is controlled by the CLREQA# pin 1: Controllable 0: Uncontrollable	R/W
3	CLREQA3#_Ctr	0	SRCCLK3 is controlled by the CLREQA# pin 1: Controllable 0: Uncontrollable	R/W
2	CLREQA0#_Ctr	0	SRCCLK0 is controlled by the CLREQA# pin 1: Controllable 0: Uncontrollable	R/W
1	Reserved	1	Reserved	R/W
0	Reserved	1	Reserved	R/W

7.4 Register 3: (Default : 03h)

BIT	AFFECTED PIN/ FUNCTION NAME(S)	PWD	FUNCTION DESCRIPTION	TYPE
7	CLREQB7#_Ctr	0	SRCCLK7 is controlled by the CLREQB# pin 1: Controllable 0: Uncontrollable	R/W
6	CLREQB6#_Ctr	0	SRCCLK6 is controlled by the CLREQB# pin 1: Controllable 0: Uncontrollable	R/W
5	CLREQB5#_Ctr	0	SRCCLK5 is controlled by the CLREQB# pin 1: Controllable 0: Uncontrollable	R/W
4	CLREQB4#_Ctr	0	SRCCLK4 is controlled by the CLREQB# pin 1: Controllable 0: Uncontrollable	R/W
3	CLREQB3#_Ctr	0	SRCCLK3 is controlled by the CLREQB# pin 1: Controllable 0: Uncontrollable	R/W

W83195WG-382/W83195CG-382



STEPLESS FOR ATI K8 CLOCK GENERATOR

2	CLREQB0#_Ctr	0	SRCCLK0 is controlled by the CLREQB# pin 1: Controllable 0: Uncontrollable	R/W
1	PCIEN	1	PCI0 output control 1: Enable 0: Disable	R/W
0	HTTEN	1	HTTCLK0 output control 1: Enable 0: Disable	R/W

7.5 Register 4: (Default : FEh)

BIT	AFFECTED PIN/ FUNCTION NAME(S)	PWD	FUNCTION DESCRIPTION	TYPE
7	Reserved	1	Reserved	R/W
6	Reserved	1	Reserved	R/W
5	Reserved	1	Reserved	R/W
4	REFEN<2>	1	PREF2 output control 1: Enable 0: Disable	R/W
3	REFEN<1>	1	PREF1 output control 1: Enable 0: Disable	R/W
2	REFEN<0>	1	PREF0 output control 1: Enable 0: Disable	R/W
1	F48EN	1	PUSB48 output control 1: Enable 0: Disable	R/W
0	Reserved	0	Reserved	R/W

7.6 Register 5: (Default : 02h)

BIT	AFFECTED PIN/ FUNCTION NAME(S)	PWD	FUNCTION DESCRIPTION	TYPE
7	Reserved	0	Reserved	R/W
6	CNT_EN	0	Program this bit => 1 : Enable Watchdog Timer feature. 0 : Disable Watchdog Timer feature. Enable WD sequence => Program this bit to 1 firstly, then program the Reg-20 to start the counting Read-back this bit => During timer count down the bit read back to 1. If count to zero, this bit read back to 0.	R/W

W83195WG-382/W83195CG-382



STEPLESS FOR ATI K8 CLOCK GENERATOR

5	WD_TIMEOUT	0	Read Back only. Timeout Flag. 1 : Watchdog has ever started and count to zero. 0 : a.) Watchdog is restarted and counting. b.) Power on default state	R
4	SAF_FREQ<4>	0	These bits will be reloaded in Reg-0 to select frequency table. As the watchdog is timeout and EN_SAFE_FREQ=1.	R/W
3	SAF_FREQ<3>	0		
2	SAF_FREQ<2>	0		
1	SAF_FREQ<1>	1		
0	SAF_FREQ<0>	0		

7.7 Register 6: (Default : FFh)

BIT	AFFECTED PIN/ FUNCTION NAME(S)	PWD	FUNCTION DESCRIPTION	TYPE
7	SRCEN<7>	1	SRC7 output control 1: Enable 0: Disable	R/W
6	SRCEN<6>	1	SRC6 output control 1: Enable 0: Disable	R/W
5	SRCEN<5>	1	SRC5 output control 1: Enable 0: Disable	R/W
4	SRCEN<4>	1	SRC4 output control 1: Enable 0: Disable	R/W
3	SRCEN<3>	1	SRC3 output control 1: Enable 0: Disable	R/W
2	ATIGEN<1>	1	ATIG1 output control 1: Enable 0: Disable ATI clock can't be controlled by CLKREQ# pins	R/W
1	ATIGEN<0>	1	ATIG0 output control 1: Enable 0: Disable ATI clock can't be controlled by CLKREQ# pins	R/W
0	SRCEN<0>	1	SRC0 output control 1: Enable 0: Disable	R/W

W83195WG-382/W83195CG-382



STEPLESS FOR ATI K8 CLOCK GENERATOR

7.8 Register 7: Winbond Chip ID – Project Code Register (Default : 06h)

BIT	AFFECTED PIN/ FUNCTION NAME(S)	PWD	FUNCTION DESCRIPTION	TYPE
7	CHIP_ID [7]	0	Winbond Chip ID.W83195C/W G -382 (BA5A06).	R
6	CHIP_ID [6]	0	Winbond Chip ID.	R
5	CHIP_ID [5]	0	Winbond Chip ID.	R
4	CHIP_ID [4]	0	Winbond Chip ID.	R
3	CHIP_ID [3]	0	Winbond Chip ID.	R
2	CHIP_ID [2]	1	Winbond Chip ID.	R
1	CHIP_ID [1]	1	Winbond Chip ID.	R
0	CHIP_ID [0]	0	Winbond Chip ID.	R

7.9 Register 8: (Default :D0h)

BIT	AFFECTED PIN/ FUNCTION NAME(S)	PWD	FUNCTION DESCRIPTION	TYPE
7	NVAL<8>	1	Programmable N divisor value. Bit 7 ~0 are defined in the Register 9.	R/W
6	NVAL<9>	1	Programmable N divisor value. Bit 7 ~0 are defined in the Register 9.	R/W
5	MVAL<5>	0	Programmable M divisor	R/W
4	MVAL<4>	1		
3	MVAL<3>	0		
2	MVAL<2>	0		
1	MVAL<1>	0		
0	MVAL<0>	0		

7.10 Register 9: (Default : 7Ah)

BIT	AFFECTED PIN/ FUNCTION NAME(S)	PWD	FUNCTION DESCRIPTION	TYPE
7	NVAL<7>	0	Programmable N divisor bit 7 ~0. The bit 8,9 is defined in Register 8.	R/W
6	NVAL<6>	1		
5	NVAL<5>	1		
4	NVAL<4>	1		
3	NVAL<3>	1		
2	NVAL<2>	0		
1	NVAL<1>	1		
0	NVAL<0>	0	Default value follow FS=0	

W83195WG-382/W83195CG-382



STEPLESS FOR ATI K8 CLOCK GENERATOR

7.11 Register 10: Reserved (Default : 3Bh)

7.12 Register 11: (Default : 0Eh)

BIT	AFFECTED PIN/ FUNCTION NAME(S)	PWD	FUNCTION DESCRIPTION	TYPE
7	SPH VAL<3>	0	Spread Spectrum Up Counter bit 3 ~ bit 0.	R/W
6	SPH VAL<2>	0		
5	SPH VAL<1>	0		
4	SPH VAL<0>	0		
3	SPL VAL<3>	1	Spread Spectrum Down Counter bit 3 ~ bit 0 2's complement representation. Ex: 1 -> 1111 ; 2 -> 1110 ; 7 -> 1001 ; 8 -> 1000	
2	SPL VAL<2>	1		
1	SPL VAL<1>	1		
0	SPL VAL<0>	0		

7.13 Register 12: (Default : XXh)

BIT	AFFECTED PIN/ FUNCTION NAME(S)	PWD	FUNCTION DESCRIPTION	TYPE
7	Reserved	0	Reserved	R/W
6	KVAL<9>	X	Define the PCI divider ratio	R/W
5	KVAL<5>	X	Table-2 integrate the all divider configuration	
4	KVAL<4>	X	Define the SRC divider ratio	R/W
3	KVAL<3>	X	Refer to Table-2	
2	KVAL<2>	X	Define the CPU divider ratio Refer to Table-2	R/W
1	KVAL<1>	X		
0	KVAL<0>	X		

Table-2 CPU, SRC, PCI divider ratio selection Table

LSB MSB		HTT/PCI		SRC		CPU			
		BIT5		BIT3		BIT1,0			
		0	1	0	1	00	01	10	11
Bit2/ Bit4/ Bit9	0	Reserved	Div10	Reserved	Div6	Div2	Div3	Div4	Div6
	1	Div12	Div15	Div8	Div10	Div8	Div8	Div8	Div8

W83195WG-382/W83195CG-382



STEPLESS FOR ATI K8 CLOCK GENERATOR

7.14 Register 13: (Default : 3Fh)

BIT	AFFECTED PIN/ FUNCTION NAME(S)	PWD	FUNCTION DESCRIPTION	TYPE
7	EN_MN_PROG	0	0: Output frequency depend on frequency table 1: Program all clock frequency by changing M/N value The equation is $VCO = 14.318MHz * (N+4) / M.$ Once the watchdog timer timeout, the bit will be clear. Then the frequency will be decided by hardware default FS<4:0> or desired frequency select SAF_FREQ[4:0] depend on EN_SAFE_FREQ (Reg0 – bit0).	
6	Reserved	0	Reserved	R/W
5	Reserved	1	Reserved	R/W
4	Reserved	1		
3	IVAL<3>	1	Charge pump current selection	R/W
2	IVAL<2>	1		
1	IVAL<1>	1		
0	IVAL<0>	1		

7.15 Register 14: (Default : D0h)

BIT	AFFECTED PIN/ FUNCTION NAME(S)	PWD	FUNCTION DESCRIPTION	TYPE
7	Reserved	1	Reserved	R/W
6	Reserved	1	Reserved	R/W
5	SPCNT<5>	0	Spread Spectrum Programmable time, the resolution is 280ns. Default period is 11.8us	R/W
4	SPCNT<4>	1		
3	SPCNT<3>	0		
2	SPCNT<2>	0		
1	SPCNT<1>	0		
0	SPCNT<0>	0		

7.16 Register 15: (Default : 5Ch)

BIT	AFFECTED PIN/ FUNCTION NAME(S)	PWD	FUNCTION DESCRIPTION	TYPE
7	INV_CPU	0	Invert the CPUCLKT1/0 phase 0: Default 1: Inverse	R/W
6	Reserved	1	Reserved	R/W

W83195WG-382/W83195CG-382



STEPLESS FOR ATI K8 CLOCK GENERATOR

5	DRI_CONT	0	SRCT/ ATIG output state in during POWER DOWN assertion. 1: Driven (2*Iref) 0: Tristate (Floating) SRCT/ ATIG output state in during STOP Mode assertion. 1: Driven (6*Iref) 0: Tristate (Floating) Complementary parts always tri-state (floating) in power down or stop mode.	R/W
4	Reserved	1	Reserved	R/W
3	CPU2HTT_SYNC	1	CPU align with HTT 1 : Enable 0 : Disable	R/W
2	AZSKEW<2>	1	CPU1 to HTT66 skew control. Skew resolution is 300ps The decision of skew direction is same as ASKEW<2:0> setting	R/W
1	AZSKEW<1>	0		
0	AZSKEW<0>	0		

7.17 Register 16: (Default : 24h)

BIT	AFFECTED PIN/ FUNCTION NAME(S)	PWD	FUNCTION DESCRIPTION	TYPE
7	INV_SRC	0	Invert the SRC phase 0: Default 1: Inverse	R/W
6	INV_PCI	0	Invert the HTT & PCI phase 0: Default 1: Inverse	R/W
5	CSKEW<2>	1	CPUCLKT1 to CPUCLKT0 skew control Skew resolution is 300ps The decision of skew direction is same as CSKEW<2:0> setting	R/W
4	CSKEW<1>	0		
3	CSKEW<0>	0		
2	PSKEW<2>	1	CPU1 to PCI skew control Skew resolution is 300ps The decision of skew direction is same as PSKEW<2:0> setting	R/W
1	PSKEW<1>	0		
0	PSKEW<0>	0		

W83195WG-382/W83195CG-382



STEPLESS FOR ATI K8 CLOCK GENERATOR

7.18 Register 17: Reserved (Default : 07h)

BIT	AFFECTED PIN/ FUNCTION NAME(S)	PWD	FUNCTION DESCRIPTION	TYPE
7	Reserved	0	Reserved	R/W
6	Reserved	0	Reserved	R/W
5	Reserved	0	Reserved	R/W
4	TURBO_EN	0	Real mode overclocking CPU. 1: Enable 0: Disable This bit should be enable before using real mode overclocking feature.	R/W
3	Reserved	0	Reserved	R/W
2	Reserved	1	Reserved	
1	NtVAL<9>	1	Dynamic programmable N divisor bit 9,8.	R/W
0	NtVAL<8>	1		

7.19 Register 18: Reserved (Default : 7Ah)

BIT	AFFECTED PIN/ FUNCTION NAME(S)	PWD	FUNCTION DESCRIPTION	TYPE
7	NtVAL<7>	0	Real-time overclocking Dynamic programmable N divisor bit 7 ~0. The bit 9,8 is defined in Register 17. Default value follow FS=2	R/W
6	NtVAL<6>	1		
5	NtVAL<5>	1		
4	NtVAL<4>	1		
3	NtVAL<3>	1		
2	NtVAL<2>	0		
1	NtVAL<1>	1		
0	NtVAL<0>	0		

7.20 Register 19: (Default : 04h)

BIT	AFFECTED PIN/ FUNCTION NAME(S)	PWD	FUNCTION DESCRIPTION	TYPE
7	SRC_FS<4>	0	SRC frequency table. See Table-3.	R/W
6	SRC_FS<3>	0	SRC_FS<4> also is spread spectrum enable bit.	R/W
5	SRC_FS<2>	0		R/W

W83195WG-382/W83195CG-382



STEPLESS FOR ATI K8 CLOCK GENERATOR

4	SRC_FS<1>	0		
3	SRC_FS<0>	0		
2	CENTERSKEW<2>	1	CPU1 center skew control Skew resolution is 300ps The decision of skew direction is same as CENTERSKEW<2:0> setting	R/W
1	CENTERSKEW<1>	0		
0	CENTERSKEW<0>	0		

7.21 Register 20: (Default : 88h)

BIT	AFFECTED PIN/ FUNCTION NAME(S)	PWD	FUNCTION DESCRIPTION	TYPE
7	Reserved	1	Reserved	R/W
6	SEC<6>	0	Setting the down count depth (Failure decision). One bit resolution represent 250ms. Default time depth is 8*250ms = 2.0 second. If the watchdog timer is counting, this register will return present down count value.	R/W
5	SEC<5>	0		
4	SEC<4>	0		
3	SEC<3>	1		
2	SEC<2>	0		
1	SEC<1>	0		
0	SEC<0>	0		

7.22 Register 21: (Default : ECh)

BIT	AFFECTED PIN/ FUNCTION NAME(S)	PWD	FUNCTION DESCRIPTION	TYPE
7	Reserved	1	Reserved	R/W
6	CPU2SRC_SYNC	1	CPU align with SRC 1 : Enable 0 : Disable	R/W
5	CPU2PCI_SYNC	1	CPU align with PCI 1 : Enable 0 : Disable	
4	Reserved	0	Reserved	R/W
3	Reserved	1	Reserved	R/W
2	SRCSKEW<2>	1	CPU1 to SRC skew control Skew resolution is 300ps The decision of skew direction is same as SRCSKEW<2:0> setting	R/W
1	SRCSKEW<1>	0		R/W
0	SRCSKEW<0>	0		R/W

W83195WG-382/W83195CG-382



STEPLESS FOR ATI K8 CLOCK GENERATOR

Table3: SRC & ATIG Frequency Selection Table

BIT 7	BIT 6	BIT 5	BIT 4	BIT 3	SRC,ATIG (MHZ)	SPREAD(%)
FS4	FS3	FS2	FS1	FS0		
0	0	0	0	0	100.00	0
0	0	0	0	1	100.00	0
0	0	0	1	0	100.00	0
0	0	0	1	1	100.00	0
0	0	1	0	0	101.00	0
0	0	1	0	1	101.00	0
0	0	1	1	0	101.00	0
0	0	1	1	1	101.00	0
0	1	0	0	0	102.00	0
0	1	0	0	1	102.00	0
0	1	0	1	0	102.00	0
0	1	0	1	1	102.00	0
0	1	1	0	0	104.00	0
0	1	1	0	1	104.00	0
0	1	1	1	0	104.00	0
0	1	1	1	1	104.00	0
1	0	0	0	0	100.00	-0.5
1	0	0	0	1	100.00	-0.5
1	0	0	1	0	100.00	-0.5
1	0	0	1	1	100.00	-0.5
1	0	1	0	0	101.00	-0.5
1	0	1	0	1	101.00	-0.5
1	0	1	1	0	101.00	-0.5
1	0	1	1	1	101.00	-0.5
1	1	0	0	0	102.00	-0.5
1	1	0	0	1	102.00	-0.5
1	1	0	1	0	102.00	-0.5
1	1	0	1	1	102.00	-0.5
1	1	1	0	0	104.00	-0.5
1	1	1	0	1	104.00	-0.5
1	1	1	1	0	104.00	-0.5
1	1	1	1	1	104.00	-0.5

W83195WG-382/W83195CG-382



STEPLESS FOR ATI K8 CLOCK GENERATOR

8. ACCESS INTERFACE

The W83195BR-382 provides I²C Serial Bus for microprocessor to read/write internal registers. In the W83195BR-382 is provided Block Read/Block Write and Byte-Data Read/Write protocol. The I²C address is defined at 0xD2.

The register number is increased by one if using byte data read/write protocol.

Example: In block mode, byte number of program register is 1
 In byte mode, byte number of program register is 2 (Byte number of block mode +1)

8.1 Block Write protocol

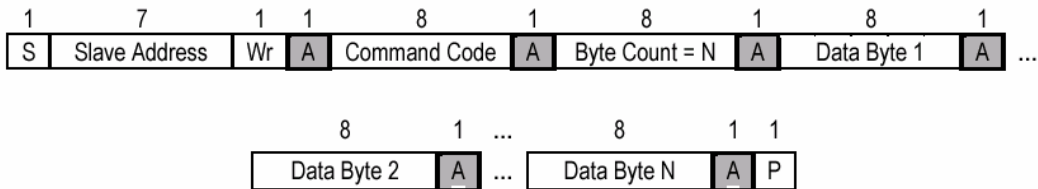

8.2 Block Read protocol

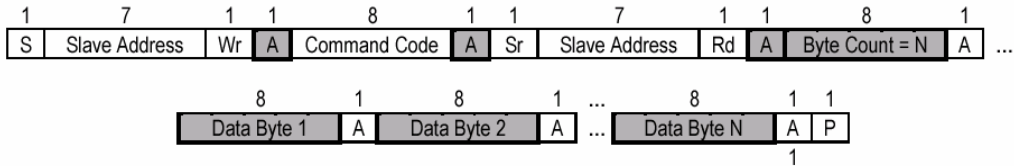

In block mode, the command code must filled 8'h00

8.3 Byte Write protocol

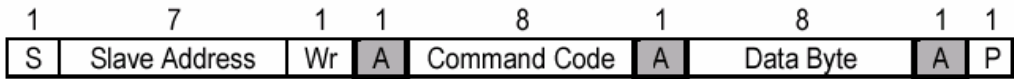

8.4 Byte Read protocol

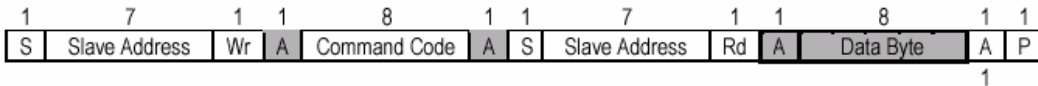

W83195WG-382/W83195CG-382



STEPLESS FOR ATI K8 CLOCK GENERATOR

9. SPECIFICATIONS

9.1 ABSOLUTE MAXIMUM RATINGS

Stresses greater than those listed in this table may cause permanent damage to the device. Precautions should be taken to avoid application of any voltage higher than the maximum rated voltages to this circuit. Subjection to maximum conditions for extended periods may affect reliability. Unused inputs must always be tied to an appropriate logic voltage level (Ground or VDD).

PARAMETER	RATING
Absolute 3.3V Core Supply Voltage	-0.5V to +4.6V
Absolute 3.3V I/O Supply Voltage	- 0.5V to + 4.6V
Operating 3.3V Core Supply Voltage	3.135V to 3.465V
Operating 3.3V I/O Supply Voltage	3.135V to 3.465V
Storage Temperature	- 65°C to + 150°C
Ambient Temperature	- 55°C to + 125°C
Operating Temperature	0°C to + 70°C
Input ESD protection (Human body model)	2000V

9.2 General Operating Characteristics

<i>VDD = 3.3V ± 5 %, TA = 0°C to +70°C,</i>					
PARAMETER	SYMBOL	MIN	MAX	UNITS	TEST CONDITIONS
Input Low Voltage	V _{IL}		0.8	V _{dc}	
Input High Voltage	V _{IH}	2.0		V _{dc}	
Output Low Voltage	V _{OL}		0.4	V _{dc}	
Output High Voltage	V _{OH}	2.4		V _{dc}	
Operating Supply Current	I _{dd}		350	mA	CPU = 100 to 400 MHz PCI = 33.3 Mhz with load 10pF
Input pin capacitance	C _{in}		5	pF	
Output pin capacitance	C _{out}		6	pF	
Input pin inductance	L _{in}		7	nH	

9.3 Skew Group timing clock

<i>VDD = 3.3V ± 5 %, TA = 0°C to +70°C, CI=10pF</i>				
Parameter	Min	Max	Units	Test Conditions
CPU pair to CPU pair Skew		100	ps	Measure Crossing point
SRC pair to SRC pair Skew		125	ps	Measure Crossing point
PCI to PCI Skew		250	ps	Measured at 1.5V
48MHz to 48MHz Skew		1000	ps	Measured at 1.5V

W83195WG-382/W83195CG-382



STEPLESS FOR ATI K8 CLOCK GENERATOR

9.4 CPU 0.7V Electrical Characteristics

VDDC= 3.3V ± 5 %, TA = 0°C to +70°C, Test load Rs=33, Rp=49.9 Cl=2pF, Vol=0.175V, Voh=0.525V, Vr=475, IREF=2.32mA, Ioh=6*IREF

Parameter	Min	Max	Units	Test Conditions
Rise Time	175	700	ps	Measure Single Ended waveform
Fall Time	175	700	ps	Measure Single Ended waveform
Absolute crossing point Voltages	250	550	mV	Measure Single Ended waveform
Voltage High	660	850	mV	Measure Single Ended waveform
Voltage Low	-150		mV	Measure Single Ended waveform
Cycle to Cycle jitter		100	ps	Measure Differential waveform
Duty Cycle	45	55	%	Measure Differential waveform

9.5 SRC 0.7V Electrical Characteristics

VDDS= 3.3V ± 5 %, TA = 0°C to +70°C, Test load Rs=33, Rp=49.9 Cl=2pF, Vol=0.175V, Voh=0.525V, Vr=475, IREF=2.32mA, Ioh=6*IREF

Parameter	Min	Max	Units	Test Conditions
Rise Time	175	700	ps	Measure Single Ended waveform
Fall Time	175	700	ps	Measure Single Ended waveform
Absolute crossing point Voltages	250	550	mV	Measure Single Ended waveform
Voltage High	660	850	mV	Measure Single Ended waveform
Voltage Low	-150		mV	Measure Single Ended waveform
Cycle to Cycle jitter		100	ps	Measure Differential waveform
Duty Cycle	45	55	%	Measure Differential waveform

9.6 ATIG 0.7V Electrical Characteristics

VDDPE= 3.3V ± 5 %, TA = 0°C to +70°C, Test load Rs=33, Rp=49.9 Cl=2pF, Vol=0.175V, Voh=0.525V, Vr=475, IREF=2.32mA, Ioh=6*IREF

Parameter	Min	Max	Units	Test Conditions
Rise Time	175	700	ps	Measure Single Ended waveform
Fall Time	175	700	ps	Measure Single Ended waveform
Absolute crossing point Voltages	250	550	mV	Measure Single Ended waveform
Voltage High	660	850	mV	Measure Single Ended waveform
Voltage Low	-150		mV	Measure Single Ended waveform
Cycle to Cycle jitter		100	ps	Measure Differential waveform
Duty Cycle	45	55	%	Measure Differential waveform

W83195WG-382/W83195CG-382



STEPLESS FOR ATI K8 CLOCK GENERATOR

9.7 PCI Electrical Characteristics

<i>VDDP= 3.3V ± 5 %, TA = 0°C to +70°C, Test load, Cl=10pF,</i>				
Parameter	Min	Max	Units	Test Conditions
Rise Time	500	2000	ps	Vol=0.4V, Voh=2.4V
Fall Time	500	2000	ps	Voh=2.4V, Vol=0.4V
Cycle to Cycle jitter		250	ps	Measured at 1.5V
Duty Cycle	45	55	%	Measured at 1.5V
Pull-Up Current Min	-33		mA	Vout=1.0V
Pull-Up Current Max		-33	mA	Vout=3.135V
Pull-Down Current Min	30		mA	Vout=1.95V
Pull-Down Current Max		38	mA	Vout=0.4V

9.8 USB Electrical Characteristics

<i>VDD48= 3.3V ± 5 %, TA = 0°C to +70°C, Test load, Cl=10pF,</i>				
Parameter	Min	Max	Units	Test Conditions
Rise Time	500	2000	ps	Vol=0.4V, Voh=2.4V
Fall Time	500	2000	ps	Voh=2.4V, Vol=0.4V
Cycle to Cycle jitter		300	ps	Measured at 1.5V
Duty Cycle	45	55	%	Measured at 1.5V
Pull-Up Current Min	-29		mA	Vout=1.0V
Pull-Up Current Max		-23	mA	Vout=3.135V
Pull-Down Current Min	29		mA	Vout=1.95V
Pull-Down Current Max		27	mA	Vout=0.4V

9.9 REF Electrical Characteristics

<i>VDD= 3.3V ± 5 %, TA = 0°C to +70°C, Test load, Cl=10pF,</i>				
Parameter	Min	Max	Units	Test Conditions
Rise Time	500	2000	ps	Vol=0.4V, Voh=2.4V
Fall Time	500	2000	ps	Voh=2.4V, Vol=0.4V
Cycle to Cycle jitter		700	ps	Measured at 1.5V
Duty Cycle	45	55	%	Measured at 1.5V
Pull-Up Current Min	-33		mA	Vout=1.0V
Pull-Up Current Max		-33	mA	Vout=3.135V
Pull-Down Current Min	30		mA	Vout=1.95V
Pull-Down Current Max		38	mA	Vout=0.4V

W83195WG-382/W83195CG-382



STEPLESS FOR ATI K8 CLOCK GENERATOR

10. ORDERING INFORMATION

PART NUMBER	PACKAGE TYPE	PRODUCTION FLOW
W83195WG-382	56 PIN TSSOP	Commercial, 0°C to +70°C
W83195CG-382	56 PIN SSOP	Commercial, 0°C to +70°C

11. HOW TO READ THE TOP MARKING

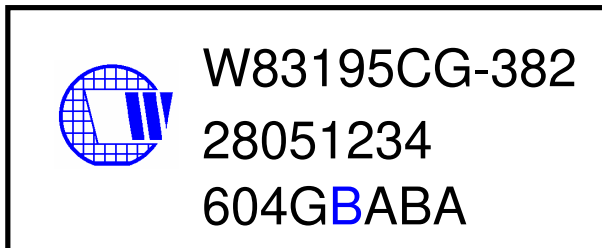
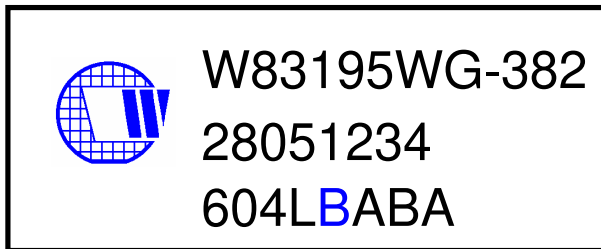

1st line: Winbond logo and the type number: W83195WG-382/W83195CG-382

2nd line: Tracking code 2 8051234

2: wafers manufactured in Winbond FAB 2

8051234: wafer production series lot number

3rd line: Tracking code 604 L B A BA

604: packages made in '2006, week 04

L: assembly house ID; O means OSE, G means GR, L means Lingsen

B: Internal use code

A: IC revision

BA: mask version

All the trademarks of products and companies mentioned in this data sheet belong to their respective owners.

Publication Release Date: Feb 2006

Revision 0.6

W83195WG-382/W83195CG-382



STEPLESS FOR ATI K8 CLOCK GENERATOR

12. PACKAGE DRAWING AND DIMENSIONS

56 PIN TSSOP-240mil

56-Lead 6.10 mm. Body, 0.50 mm. Pitch TSSOP (240 mil)

SYMBOL	In Millimeters		In Inches	
	COMMON DIMENSIONS		COMMON DIMENSIONS	
A	—	1.20	—	.047
A1	0.05	0.15	.002	.006
A2	0.80	1.05	.032	.041
b	0.17	0.27	.007	.011
c	0.09	0.20	.0035	.008
D	SEE VARIATIONS		SEE VARIATIONS	
E	8.10 BASIC		0.319 BASIC	
E1	6.00	6.20	.236	.244
e	0.50 BASIC		0.020 BASIC	
L	0.45	0.75	.018	.030
N	SEE VARIATIONS		SEE VARIATIONS	
a	0°	8°	0°	8°
aaa	—	0.10	—	.004

N	D mm.		D (inch)	
	MIN	MAX	MIN	MAX
56	13.90	14.10	.547	.555

Reference Doc.: JEDEC Publication 95, MO-153
10-0039

56 PIN SSOP-300mil

SYMBOL	DIMENSION IN MM			DIMENSION IN INCH		
	MIN.	NOM	MAX.	MIN.	NOM	MAX.
A	2.41	2.57	2.79	0.095	0.101	0.110
A1	0.20	0.30	0.41	0.008	0.012	0.016
A2	2.24	2.29	2.34	0.088	0.090	0.092
b	0.20	0.25	0.34	0.008	0.010	0.0135
c	0.13	—	0.25	0.005	—	0.010
D	18.2	18.42	18.54	0.720	0.725	0.730
H _B	10.16	10.31	10.41	0.400	0.406	0.410
E	7.42	7.52	7.59	0.292	0.296	0.299
e	0.51	0.64	0.76	0.020	0.025	0.030
L	0.61	0.81	1.02	0.024	0.032	0.040
L1	—	1.40	—	—	0.055	—
Y	—	—	0.08	—	—	0.003
θ	0	—	8	0	—	8

W83195WG-382/W83195CG-382



STEPLESS FOR ATI K8 CLOCK GENERATOR

Important Notice

Winbond products are not designed, intended, authorized or warranted for use as components in systems or equipment intended for surgical implantation, atomic energy control instruments, airplane or spaceship instruments, transportation instruments, traffic signal instruments, combustion control instruments, or for other applications intended to support or sustain life. Further more, Winbond products are not intended for applications wherein failure of Winbond products could result or lead to a situation wherein personal injury, death or severe property or environmental damage could occur.

Winbond customers using or selling these products for use in such applications do so at their own risk and agree to fully indemnify Winbond for any damages resulting from such improper use or sales.



Headquarters

No. 4, Creation Rd. III,
Science-Based Industrial Park,
Hsinchu, Taiwan
TEL: 886-3-5770066
FAX: 886-3-5665577
<http://www.winbond.com.tw/>

Taipei Office

9F, No.480, Rueiguang Rd.,
Neihu District, Taipei, 114,
Taiwan, R.O.C.
TEL: 886-2-8177-7168
FAX: 886-2-8751-3579

Winbond Electronics Corporation America Winbond Electronics (Shanghai) Ltd

2727 North First Street, San Jose,
CA 95134, U.S.A.
TEL: 1-408-9436666
FAX: 1-408-5441798

27F, 2299 Yan An W. Rd. Shanghai,
200336 China
TEL: 86-21-62365999
FAX: 86-21-62365998

Winbond Electronics Corporation Japan

7F Daini-ueno BLDG, 3-7-18
Shinyokohama Kohoku-ku,
Yokohama, 222-0033
TEL: 81-45-4781881
FAX: 81-45-4781800

Winbond Electronics (H.K.) Ltd.

Unit 9-15, 22F, Millennium City,
No. 378 Kwun Tong Rd.,
Kowloon, Hong Kong
TEL: 852-27513100
FAX: 852-27552064

*Please note that all data and specifications are subject to change without notice.
All the trade marks of products and companies mentioned in this data sheet belong to their respective owners.*

Publication Release Date: Feb 2006

Revision 0.6