

# MJ14001 (PNP), MJ14002\* (NPN), MJ14003\* (PNP)

\*Preferred Devices

## High-Current Complementary Silicon Power Transistors

Designed for use in high-power amplifier and switching circuit applications.

### Features

- High Current Capability –  $I_C$  Continuous = 60 Amperes
- DC Current Gain –  $h_{FE} = 15-100$  @  $I_C = 50$  Adc
- Low Collector–Emitter Saturation Voltage –  $V_{CE(sat)} = 2.5$  Vdc (Max) @  $I_C = 50$  Adc
- Pb–Free Packages are Available\*

### MAXIMUM RATINGS ( $T_J = 25^\circ\text{C}$ unless otherwise noted)

Rating	Symbol	Value	Unit
Collector–Emitter Voltage MJ14001 MJ14002/03	$V_{CEO}$	60 80	Vdc
Collector–Base Voltage MJ14001 MJ14002/03	$V_{CBO}$	60 80	Vdc
Emitter–Base Voltage	$V_{EBO}$	5.0	Vdc
Collector Current – Continuous	$I_C$	60	Adc
Base Current – Continuous	$I_B$	15	Adc
Emitter Current – Continuous	$I_E$	75	Adc
Total Power Dissipation @ $T_C = 25^\circ\text{C}$ Derate Above $25^\circ\text{C}$	$P_D$	300 1.71	W W/ $^\circ\text{C}$
Operating and Storage Junction Temperature Range	$T_J, T_{stg}$	-65 to +200	$^\circ\text{C}$

Maximum ratings are those values beyond which device damage can occur. Maximum ratings applied to the device are individual stress limit values (not normal operating conditions) and are not valid simultaneously. If these limits are exceeded, device functional operation is not implied, damage may occur and reliability may be affected.

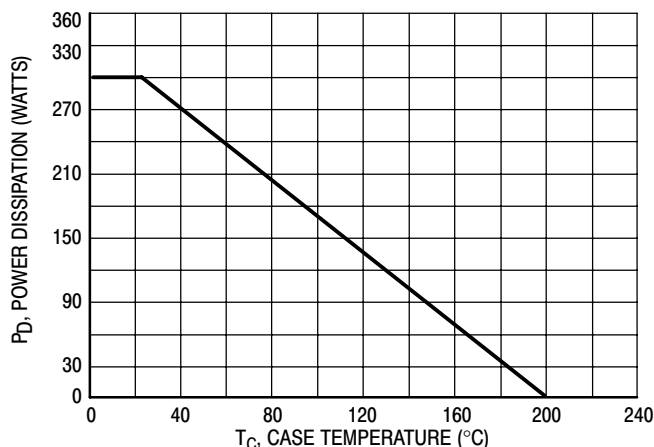

Figure 1. Power Derating



ON Semiconductor®

<http://onsemi.com>

## 60 AMPERE COMPLEMENTARY SILICON POWER TRANSISTORS 60–80 VOLTS, 300 WATTS

### MARKING DIAGRAM

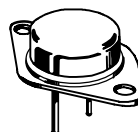

TO–204 (TO–3)  
CASE 197A  
STYLE 1

MJ1400x = Device Code  
          xx = 1, 2, or 3  
G      = Pb–Free Package  
A      = Location Code  
YY     = Year  
WW     = Work Week  
MEX    = Country of Origin

### ORDERING INFORMATION

Device	Package	Shipping
MJ14001	TO–3	100 Units/Tray
MJ14001G	TO–3 (Pb–Free)	100 Units/Tray
MJ14002	TO–3	100 Units/Tray
MJ14002G	TO–3 (Pb–Free)	100 Units/Tray
MJ14003	TO–3	100 Units/Tray
MJ14003G	TO–3 (Pb–Free)	100 Units/Tray

Preferred devices are recommended choices for future use and best overall value.

\*For additional information on our Pb–Free strategy and soldering details, please download the ON Semiconductor Soldering and Mounting Techniques Reference Manual, SOLDERRM/D.

# MJ14001 (PNP), MJ14002\* (NPN), MJ14003\* (PNP)

## THERMAL CHARACTERISTICS

Characteristic	Symbol	Max	Unit
Thermal Resistance, Junction-to-Case	$R_{\theta JC}$	0.584	$^{\circ}C/W$

## ELECTRICAL CHARACTERISTICS ( $T_C = 25^{\circ}C$ unless otherwise noted)

Characteristic	Symbol	Min	Max	Unit
<b>OFF CHARACTERISTICS</b>				
Collector-Emitter Sustaining Voltage (Note 1) ( $I_C = 200 \text{ mAdc}$ , $I_B = 0$ )	$V_{CE(sus)}$	60 80	– –	Vdc
Collector Cutoff Current ( $V_{CE} = 30 \text{ Vdc}$ , $I_B = 0$ ) ( $V_{CE} = 40 \text{ Vdc}$ , $I_B = 0$ )	$I_{CEO}$	– –	1.0 1.0	mA
Collector Cutoff Current ( $V_{CE} = 60 \text{ Vdc}$ , $V_{BE(off)} = 1.5 \text{ V}$ ) ( $V_{CE} = 80 \text{ Vdc}$ , $V_{BE(off)} = 1.5 \text{ V}$ )	$I_{CEX}$	– –	1.0 1.0	mA
Collector Cutoff Current ( $V_{CB} = 60 \text{ Vdc}$ , $I_E = 0$ ) ( $V_{CB} = 80 \text{ Vdc}$ , $I_E = 0$ )	$I_{CBO}$	– –	1.0 1.0	mA
Emitter Cutoff Current ( $V_{BE} = 5.0 \text{ Vdc}$ , $I_C = 0$ )	$I_{EBO}$	–	1.0	mA
<b>ON CHARACTERISTICS</b>				
DC Current Gain (Note 1) ( $I_C = 25 \text{ Adc}$ , $V_{CE} = 3.0 \text{ V}$ ) ( $I_C = 50 \text{ Adc}$ , $V_{CE} = 3.0 \text{ V}$ ) ( $I_C = 60 \text{ Adc}$ , $V_{CE} = 3.0 \text{ V}$ )	$h_{FE}$	30 15 5.0	– 100 –	–
Collector-Emitter Saturation Voltage (Note 1) ( $I_C = 25 \text{ Adc}$ , $I_B = 2.5 \text{ Adc}$ ) ( $I_C = 50 \text{ Adc}$ , $I_B = 5.0 \text{ Adc}$ ) ( $I_C = 60 \text{ Adc}$ , $I_B = 12 \text{ Adc}$ )	$V_{CE(sat)}$	– – –	1.0 2.5 3.0	Vdc
Base-Emitter Saturation Voltage (Note 1) ( $I_C = 25 \text{ Adc}$ , $I_B = 2.5 \text{ Adc}$ ) ( $I_C = 50 \text{ Adc}$ , $I_B = 5.0 \text{ Adc}$ ) ( $I_C = 60 \text{ Adc}$ , $I_B = 12 \text{ Adc}$ )	$V_{BE(sat)}$	– – –	2.0 3.0 4.0	Vdc
<b>DYNAMIC CHARACTERISTICS</b>				
Output Capacitance ( $V_{CB} = 10 \text{ Vdc}$ , $I_E = 0$ , $f = 0.1 \text{ MHz}$ )	$C_{ob}$	–	2000	pF

1. Pulse Test: Pulse Width  $\leq 300 \mu s$ , Duty Cycle  $\leq 2.0\%$ .

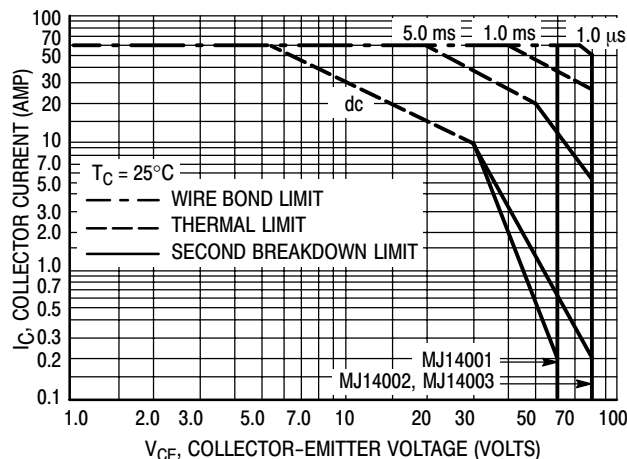

**Figure 2. Maximum Rated Forward Biased Safe Operating Area**

There are two limitations on the power handling ability of a transistor: average junction temperature and second breakdown. Safe operating area curves indicate  $I_C - V_{CE}$  limits of the transistor that must be observed for reliable operation: i.e., the transistor must not be subjected to greater dissipation than the curves indicate.

The data of Figure 2 is based on  $T_{J(pk)} = 200^{\circ}C$ ;  $T_C$  is variable depending on conditions. Second breakdown pulse limits are valid for duty cycles to 10% provided  $T_{J(pk)} \leq 200^{\circ}C$ .  $T_{J(pk)}$  may be calculated from the data in Figure 13. At high case temperatures, thermal limitations will reduce the power that can be handled to values less than the limitations imposed by second breakdown.

# MJ14001 (PNP), MJ14002\* (NPN), MJ14003\* (PNP)

## TYPICAL ELECTRICAL CHARACTERISTICS

MJ14002 (NPN)

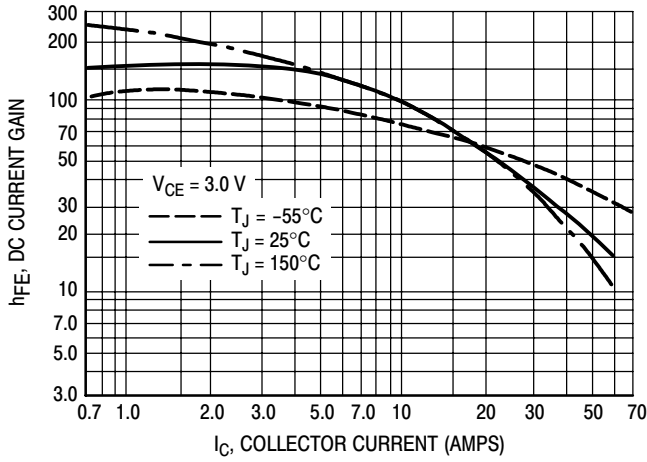

Figure 3. DC Current Gain

MJ14001, MJ14003 (PNP)

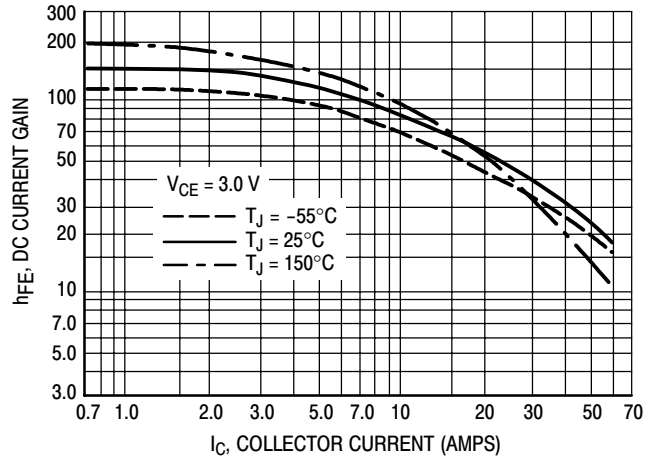

Figure 4. DC Current Gain

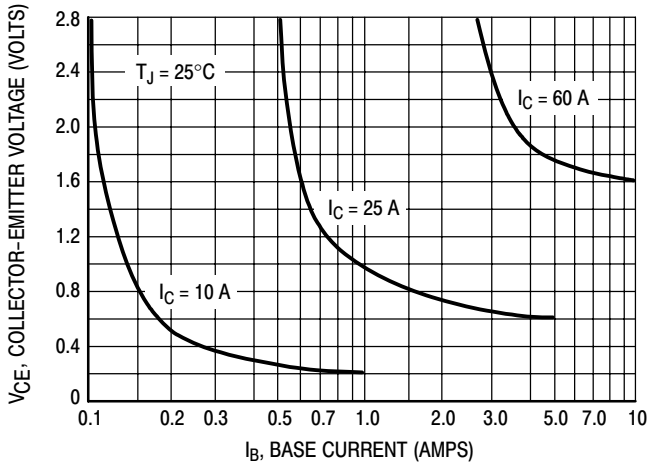

Figure 5. Collector Saturation Region

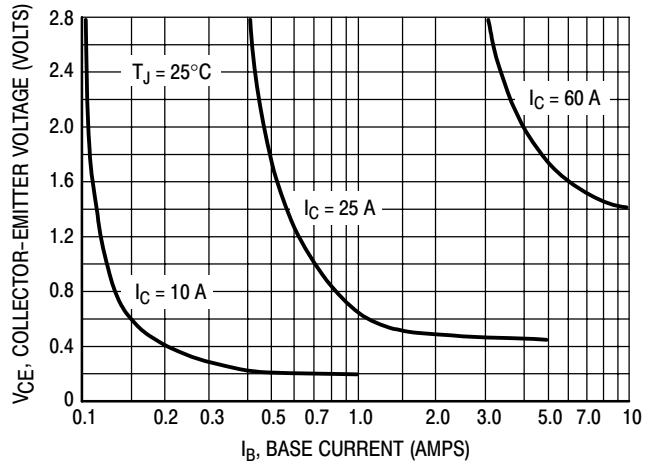

Figure 6. Collector Saturation Region

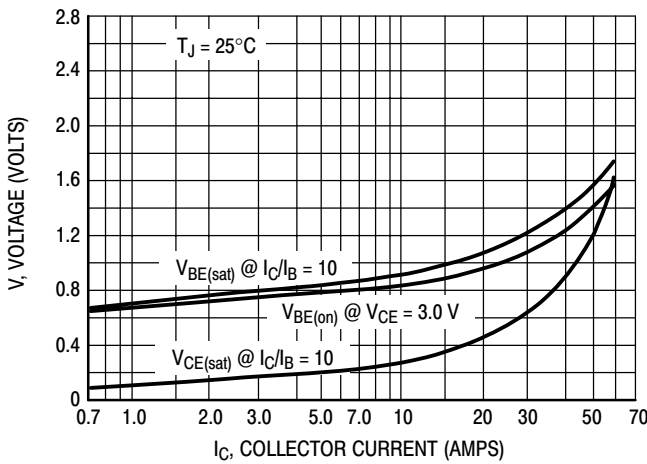

Figure 7. "On" Voltages

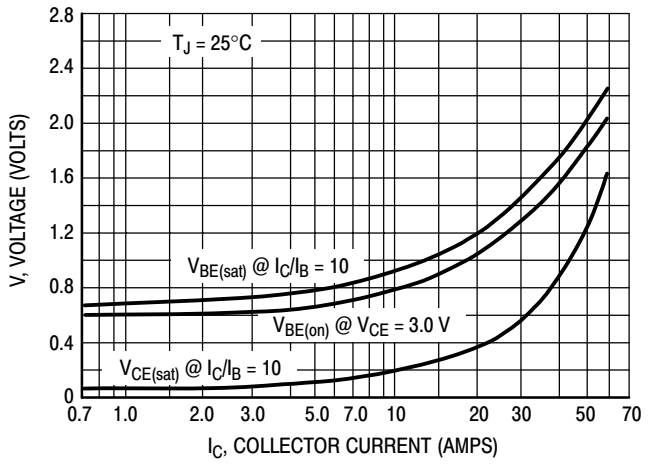

Figure 8. "On" Voltages

# MJ14001 (PNP), MJ14002\* (NPN), MJ14003\* (PNP)

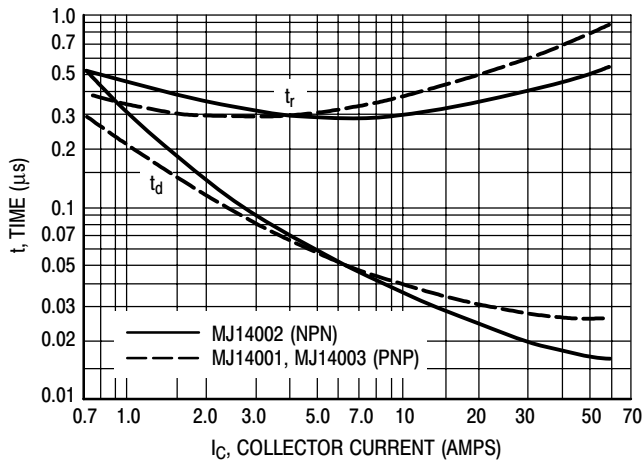

Figure 9. Turn-On Switching Times

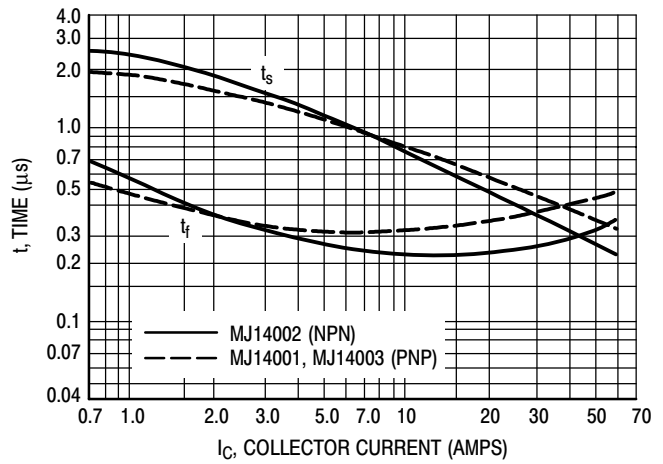

Figure 10. Turn-Off Switching Times

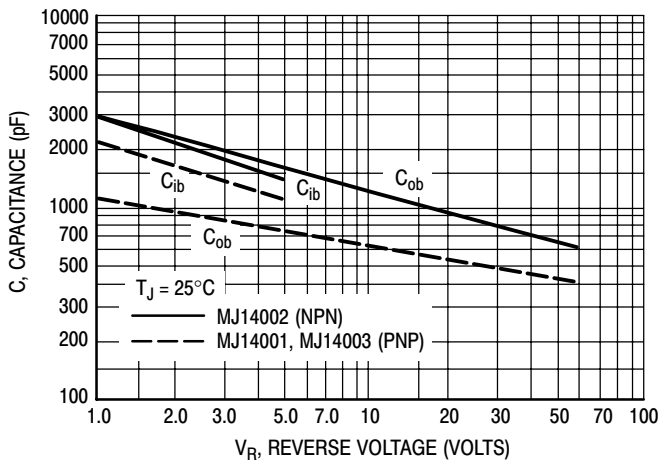
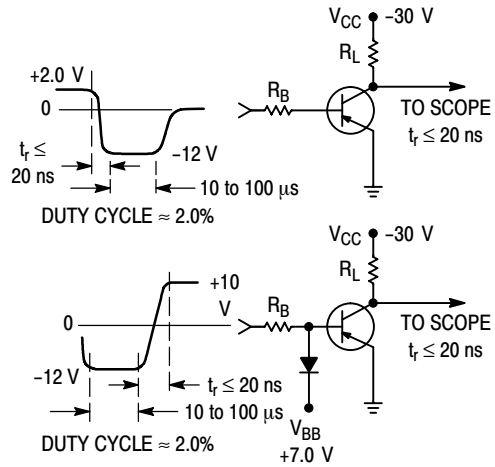

Figure 11. Capacitance Variation



FOR CURVES OF FIGURES 3 & 6,  $R_B$  &  $R_L$  ARE VARIED. INPUT LEVELS ARE APPROXIMATELY AS SHOWN. FOR NPN CIRCUITS, REVERSE ALL POLARITIES.

Figure 12. Switching Test Circuit

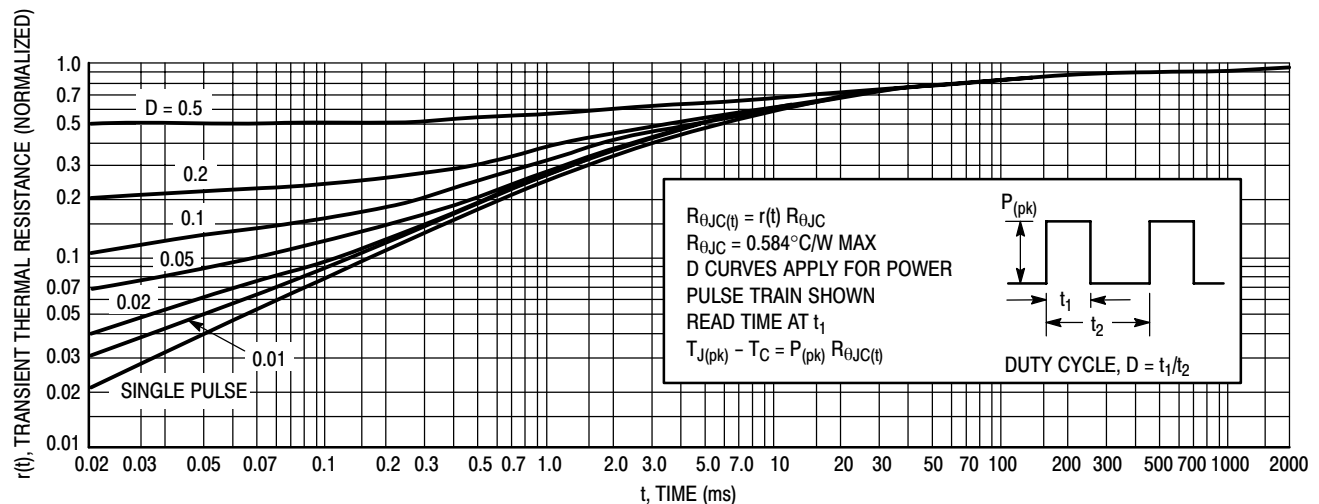
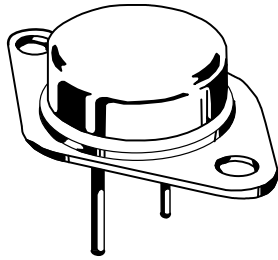

Figure 13. Thermal Response

# MECHANICAL CASE OUTLINE

## PACKAGE DIMENSIONS

ON Semiconductor®



SCALE 1:1

TO-204 (TO-3)  
CASE 197A-05  
ISSUE K

DATE 21 FEB 2000

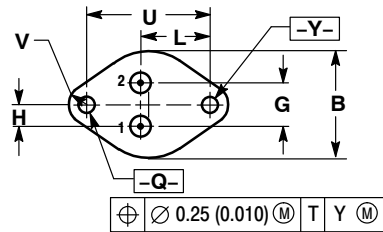
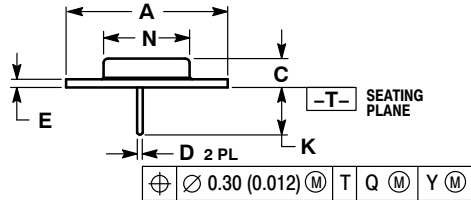

- NOTES:
- DIMENSIONING AND TOLERANCING PER ANSI Y14.5M, 1982.
  - CONTROLLING DIMENSION: INCH.

DIM	INCHES		MILLIMETERS	
	MIN	MAX	MIN	MAX
A	1.530 REF		38.86 REF	
B	0.990	1.050	25.15	26.67
C	0.250	0.335	6.35	8.51
D	0.057	0.063	1.45	1.60
E	0.060	0.070	1.53	1.77
G	0.430 BSC		10.92 BSC	
H	0.215 BSC		5.46 BSC	
K	0.440	0.480	11.18	12.19
L	0.665 BSC		16.89 BSC	
N	0.760	0.830	19.31	21.08
Q	0.151	0.165	3.84	4.19
U	1.187 BSC		30.15 BSC	
V	0.131	0.188	3.33	4.77

### GENERIC MARKING DIAGRAM\*

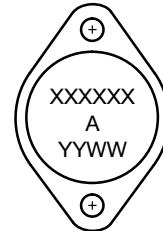

XXXXXX = Specific Device Code  
A = Assembly Location  
YY = Year  
WW = Work Week

\*This information is generic. Please refer to device data sheet for actual part marking.

- |  |  |   |  |
|--|--|---|--|
| STYLE 1:<br>PIN 1. BASE<br>2. EMITTER<br>CASE: COLLECTOR | STYLE 2:<br>PIN 1. EMITTER<br>2. BASE<br>CASE: COLLECTOR | STYLE 3:<br>PIN 1. GATE<br>2. SOURCE<br>CASE: DRAIN | STYLE 4:<br>PIN 1. ANODE = 1<br>2. ANODE = 2<br>CASE: CATHODES |
|--|--|---|--|

DOCUMENT NUMBER:	98ASB42128B	Electronic versions are uncontrolled except when accessed directly from the Document Repository. Printed versions are uncontrolled except when stamped "CONTROLLED COPY" in red.
STATUS:	ON SEMICONDUCTOR STANDARD	
NEW STANDARD:		
DESCRIPTION:	TO-204 (TO-3)	PAGE 1 OF 2



ISSUE	REVISION	DATE
K	LEGALLY CHANGED TO ON	21 FEB 2000

**ON Semiconductor** and  are registered trademarks of Semiconductor Components Industries, LLC (SCILLC). SCILLC reserves the right to make changes without further notice to any products herein. SCILLC makes no warranty, representation or guarantee regarding the suitability of its products for any particular purpose, nor does SCILLC assume any liability arising out of the application or use of any product or circuit, and specifically disclaims any and all liability, including without limitation special, consequential or incidental damages. "Typical" parameters which may be provided in SCILLC data sheets and/or specifications can and do vary in different applications and actual performance may vary over time. All operating parameters, including "Typicals" must be validated for each customer application by customer's technical experts. SCILLC does not convey any license under its patent rights nor the rights of others. SCILLC products are not designed, intended, or authorized for use as components in systems intended for surgical implant into the body, or other applications intended to support or sustain life, or for any other application in which the failure of the SCILLC product could create a situation where personal injury or death may occur. Should Buyer purchase or use SCILLC products for any such unintended or unauthorized application, Buyer shall indemnify and hold SCILLC and its officers, employees, subsidiaries, affiliates, and distributors harmless against all claims, costs, damages, and expenses, and reasonable attorney fees arising out of, directly or indirectly, any claim of personal injury or death associated with such unintended or unauthorized use, even if such claim alleges that SCILLC was negligent regarding the design or manufacture of the part. SCILLC is an Equal Opportunity/Affirmative Action Employer.

**onsemi**, **Onsemi**, and other names, marks, and brands are registered and/or common law trademarks of Semiconductor Components Industries, LLC dba "**onsemi**" or its affiliates and/or subsidiaries in the United States and/or other countries. **onsemi** owns the rights to a number of patents, trademarks, copyrights, trade secrets, and other intellectual property. A listing of **onsemi**'s product/patent coverage may be accessed at [www.onsemi.com/site/pdf/Patent-Marking.pdf](http://www.onsemi.com/site/pdf/Patent-Marking.pdf). **onsemi** reserves the right to make changes at any time to any products or information herein, without notice. The information herein is provided "as-is" and **onsemi** makes no warranty, representation or guarantee regarding the accuracy of the information, product features, availability, functionality, or suitability of its products for any particular purpose, nor does **onsemi** assume any liability arising out of the application or use of any product or circuit, and specifically disclaims any and all liability, including without limitation special, consequential or incidental damages. Buyer is responsible for its products and applications using **onsemi** products, including compliance with all laws, regulations and safety requirements or standards, regardless of any support or applications information provided by **onsemi**. "Typical" parameters which may be provided in **onsemi** data sheets and/or specifications can and do vary in different applications and actual performance may vary over time. All operating parameters, including "Typicals" must be validated for each customer application by customer's technical experts. **onsemi** does not convey any license under any of its intellectual property rights nor the rights of others. **onsemi** products are not designed, intended, or authorized for use as a critical component in life support systems or any FDA Class 3 medical devices or medical devices with a same or similar classification in a foreign jurisdiction or any devices intended for implantation in the human body. Should Buyer purchase or use **onsemi** products for any such unintended or unauthorized application, Buyer shall indemnify and hold **onsemi** and its officers, employees, subsidiaries, affiliates, and distributors harmless against all claims, costs, damages, and expenses, and reasonable attorney fees arising out of, directly or indirectly, any claim of personal injury or death associated with such unintended or unauthorized use, even if such claim alleges that **onsemi** was negligent regarding the design or manufacture of the part. **onsemi** is an Equal Opportunity/Affirmative Action Employer. This literature is subject to all applicable copyright laws and is not for resale in any manner.

## ADDITIONAL INFORMATION

### TECHNICAL PUBLICATIONS:

Technical Library: [www.onsemi.com/design/resources/technical-documentation](http://www.onsemi.com/design/resources/technical-documentation)  
onsemi Website: [www.onsemi.com](http://www.onsemi.com)

### ONLINE SUPPORT: [www.onsemi.com/support](http://www.onsemi.com/support)

For additional information, please contact your local Sales Representative at [www.onsemi.com/support/sales](http://www.onsemi.com/support/sales)