

CTL0805FRD1T DATASHEET

Chip Type LED, 0805, Flat Lens, Red



VENKEL LTD.

Part Number	Size	Emitting Color	Emitting Material	Lens-Color	Luminous Intensity ($I_F=20\text{mA}$) mcd	Wavelength nm λ_P	Viewing Angle ($2\theta_{1/2}$)
CTL0805FRD1T	0805	Red	AlGaInP	Water Clear	50 min 80 typ	640	140°

Electrical & Optical Specifications ($T_A=25^\circ\text{C}$)		RD1 (AlGaInP)	Unit
Forward Voltage (Min.) ($I_F=20\text{mA}$)	V_F	1.5	V
Forward Voltage (Max.) ($I_F=20\text{mA}$)	V_F	2.4	V
Reverse Current (Max) ($V_R=5\text{V}$)	I_R	10	μA
Peak Wavelength (Typ.) ($I_F=20\text{mA}$)	λ_P	640	nm
Dominant Wavelength (Typ.) ($I_F=20\text{mA}$)	λ_D	630	nm
Spectral Line Half Width (Typ.) ($I_F=20\text{mA}$)	$\Delta\lambda$	20	nm

Absolute Maximum Ratings ($T_A=25^\circ\text{C}$)		RD1 (AlGaInP)	Unit
Reverse Voltage	V_R	5	V
DC Forward Current	I_F	25	mA
Peak Forward Current 1/10 Duty Cycle @ 10KHz	I_{FP}	75	mA
Power Dissipation	P_D	60	mW
Operating Temperature	T_A	-40 ~ +85	°C
Storage Temperature	T_{stg}	-40 ~ +100	

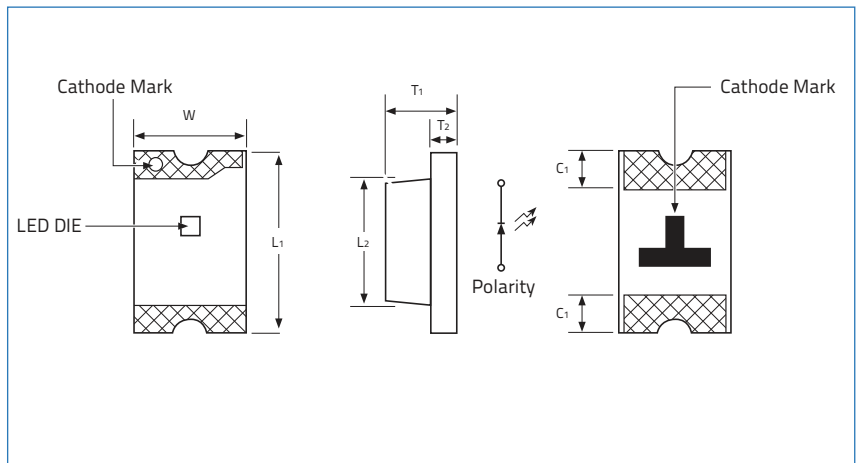

Dimensions		Units: Inches (mm)	
L_1	L_2	T_1	T_2
0.079±0.004 (2.0±0.1)	0.055±0.004 (1.4±0.1)	0.0314±0.004 (0.8±0.1)	0.0118±0.004 (0.3±0.1)
W	C		
0.049±0.004 (1.25±0.1)	0.016±0.004 (0.4±0.1)		

Soldering Pad Layout

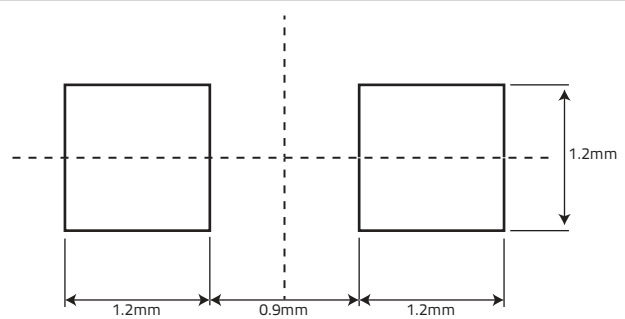

Tolerances are all ±0.1mm

CTL0805FRD1T DATASHEET

Chip Type LED, 0805, Flat Lens, Red



VENKEL LTD.

Graphs

Fig.1 Forward Current vs Forward Voltage

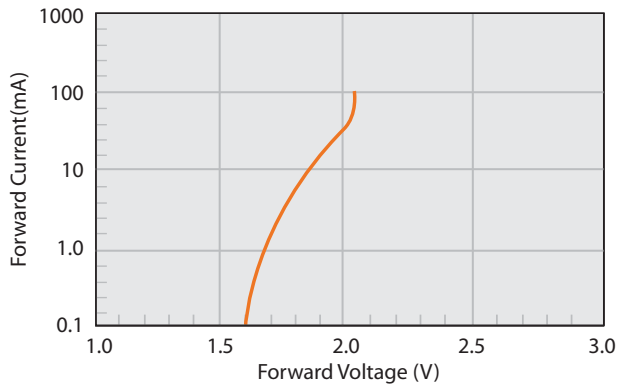

Fig.4 Relative Intensity vs Temperature

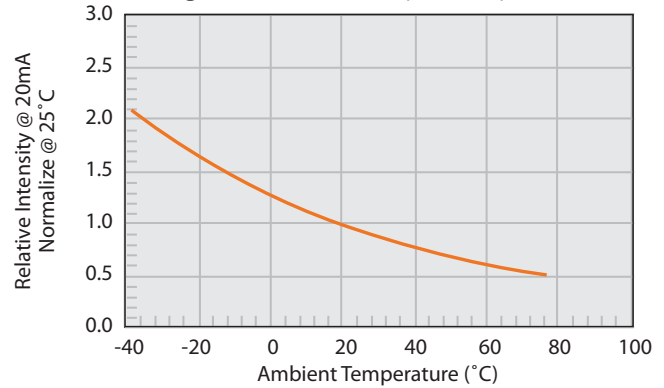

Fig.2 Relative Intensity vs Forward Current

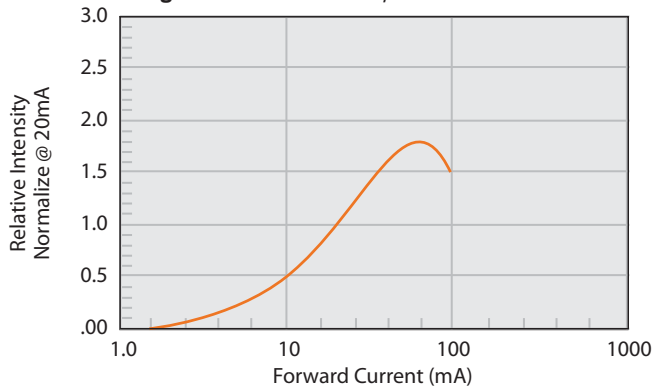

Fig.5 Relative Intensity vs Wavelength

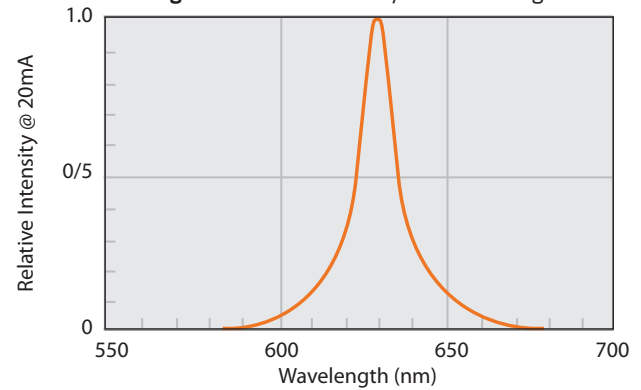

Fig.3 Current vs Temp

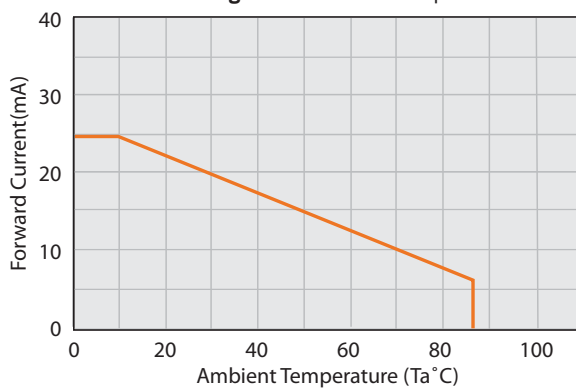
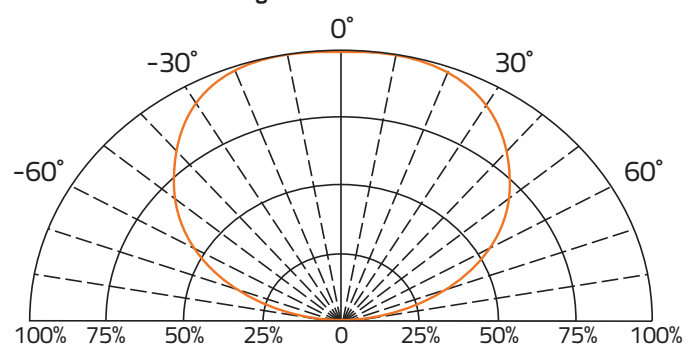

Fig. 6 Direct Radiation



Environmental information

RoHS Status	6 of 6 Compliant
REACH Status	Compliant
Halogen Status	Halogen Free
Conflict Mineral Status	Conflict Mineral Free
Moisture Sensitivity Level (MSL)	3

Reflow profile

Max Reflow Temperature	260°C
Number of Reflow Cycles	2

CTL0805FRD1T DATASHEET

Chip Type LED, 0805, Flat Lens, Red



VENKEL LTD.

Label Example

Item: CTL0805FRD1T

Chip Type LED,0805,Flat Lens,RED

Qty: 4000

D/C: 1616

Lot: 20160502001

BIN/HUE: P/30

VF: 1.8-2.0

VENKEL LTD

YOUR SINGLE SOURCE FOR SURFACE MOUNT PASSIVES

Codes:

VF: Forward Voltage | BIN: Luminous Intensity | HUE: Dominant Wavelength

Luminous Intensity Classification (BIN Code)

BIN Code	Iv(mcd) at 20mA	
	Min.	Max.
P	50	80
Q	80	125
R	125	200
S	200	320

Dominant Wavelength Classification (HUE Code)

HUE Code	λ_D (nm) at 20mA	
	Min.	Max.
29	624	627
30	627	630
31	630	633
32	633	636

CTL0805FRD1T DATASHEET

Chip Type LED, 0805, Flat Lens, Red



VENKEL LTD.

Reel Specifications Units: mm

M	C	F	E	G
178±1.50	56.0±1.0	12.0±1.0	60.0±1.0	9.0±1.0

Packaging Specifications

Reel Size:	7"
Quantity per Reel :	4,000

Storage Specifications

1. Storage temperature and RH: 5°C~35°C, RH60%
2. Once the package is opened, the LEDs should be used within a week. Otherwise, they should be kept in a moisture proof bag with desiccant. We suggest that you use this product within one year from date code.
3. If opened for more than one week in an atmosphere of 5°C~35°C, RH60%. The parts should be heat treated at 60°C±5°C for 15 hours.

Tape Specifications Units: mm

T	W	A	B	F
0.87±0.5	8.0±0.3	2.22±0.5	1.36±0.1	3.5±0.2
E	H	J	D	G
1.75±0.1	4.0±0.2	2.0±0.1	1.5±0.1	4.0±0.2

CTL0805FRD1T DATASHEET

Chip Type LED, 0805, Flat Lens, Red



VENKEL LTD.

Environmental Test Criteria			
Classification	Test Item	Test Condition	Sample Size
Endurance Test	Operating Life	1. Ta=25°C 2. If=20mA 3. t=1000hrs (-24hrs, +72hrs)	22
	High Temperature Storage	1. Ta=105°C±5°C 2. t=1000hrs (-24hrs, +72hrs)	22
	Low Temperature Storage	1. Ta=-40°C±5°C 2. t=1000hrs (-24hrs, +72hrs)	22
	High Temperature, High Humidity Storage	1. Ta=85°C 2. RH=85% 3. t=1000hrs(-24hrs, +72hrs)	22
Environmental Test	Thermal Shock	1. Ta=100°C±5°C & -40°C±5°C 20min / 10sec / 20min 3. Total: 100 cycles total	22
	Temperature Cycling	1. 100°C±5°C & -40°C±5°C 30mins / 5mins / 30mins 2. 100 Cycles	22
	IR Reflow	1. T=260°C Max. 10 seconds Max 2. 6 Min	22

Drive Method

LED is a current operated drive, and therefore it requires some kind of current limiting incorporated into the driver circuit. This current limiting typically takes the form of a current limiting resistor placed in series with the LED. Consider worst case voltage variations that can occur across the current limiting resistor placed in series with the LED. The forward current should not be allowed to change by more than 40% of its desired value.

Circuit model A

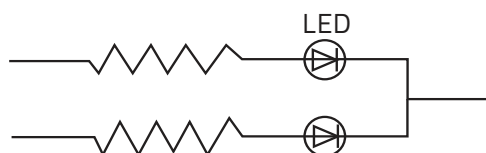

Circuit model B

