

FR FAMILY EVALUATION BOARD STARTERKIT MB91364

USER GUIDE

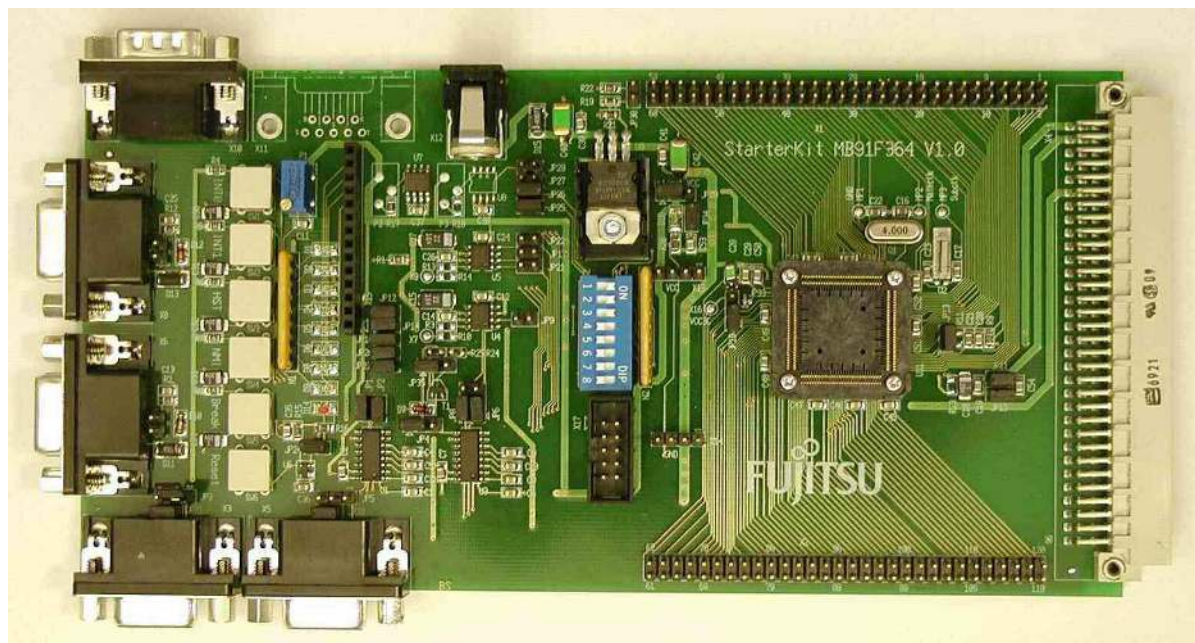

Revision History

Date	Issue
12.09.2002	V1.0 First Release
07/02/2003	V1.1, Disclaimer corrected

This document contains 25 pages.

Warranty and Disclaimer

To the maximum extent permitted by applicable law, Fujitsu Microelectronics Europe GmbH restricts its warranties and its liability for **STARTERKITMB91364 and all its deliverables** (eg. software include or header files, application examples, target boards, evaluation boards, engineering samples of IC's etc.), its performance and any consequential damages, on the use of the Product in accordance with (i) the terms of the License Agreement and the Sale and Purchase Agreement under which agreements the Product has been delivered, (ii) the technical descriptions and (iii) all accompanying written materials. In addition, to the maximum extent permitted by applicable law, Fujitsu Microelectronics Europe GmbH disclaims all warranties and liabilities for the performance of the Product and any consequential damages in cases of unauthorised decompiling and/or reverse engineering and/or disassembling. **Note, STARTERKITMB91364 and all its deliverables are intended and must only be used in an evaluation laboratory environment.**

1. Fujitsu Microelectronics Europe GmbH warrants that the Product will perform substantially in accordance with the accompanying written materials for a period of 90 days from the date of receipt by the customer. Concerning the hardware components of the Product, Fujitsu Microelectronics Europe GmbH warrants that the Product will be free from defects in material and workmanship under use and service as specified in the accompanying written materials for a duration of 1 year from the date of receipt by the customer.
2. Should a Product turn out to be defect, Fujitsu Microelectronics Europe GmbH's entire liability and the customer's exclusive remedy shall be, at Fujitsu Microelectronics Europe GmbH's sole discretion, either return of the purchase price and the license fee, or replacement of the Product or parts thereof, if the Product is returned to Fujitsu Microelectronics Europe GmbH in original packing and without further defects resulting from the customer's use or the transport. However, this warranty is excluded if the defect has resulted from an accident not attributable to Fujitsu Microelectronics Europe GmbH, or abuse or misapplication attributable to the customer or any other third party not relating to Fujitsu Microelectronics Europe GmbH.
3. To the maximum extent permitted by applicable law Fujitsu Microelectronics Europe GmbH disclaims all other warranties, whether expressed or implied, in particular, but not limited to, warranties of merchantability and fitness for a particular purpose for which the Product is not designated.
4. To the maximum extent permitted by applicable law, Fujitsu Microelectronics Europe GmbH's and its supplier's liability are restricted to intention and gross negligence.

NO LIABILITY FOR CONSEQUENTIAL DAMAGES

To the maximum extent permitted by applicable law, in no event shall Fujitsu Microelectronics Europe GmbH and its suppliers be liable for any damages whatsoever (including but without limitation, consequential and/or indirect damages for personal injury, assets of substantial value, loss of profits, interruption of business operation, loss of information, or any other monetary or pecuniary loss) arising from the use of the Product.

Should one of the above stipulations be or become invalid and/or unenforceable, the remaining stipulations shall stay in full effect

Contents

REVISION HISTORY	2
WARRANTY AND DISCLAIMER	3
CONTENTS	4
1 OVERVIEW	5
1.1 Abstract.....	5
1.2 Features.....	5
1.3 General Description.....	6
2 INSTALLATION	7
3 JUMPERS AND SWITCHES.....	8
3.1 Jumper Overview	8
3.2 Operating-Mode (S2).....	10
3.3 Power Supply Voltage (JP: 19, 29, 33, 34).....	11
3.4 Analogue Power Supply Voltage (JP: 11, 13, 15).....	12
3.5 RS232- and LIN-Interfaces (JP: 1, 2, 6, 8, 9, 10, 17, 18, 21, 22, 31, 32).....	12
3.6 CAN Interface (JP: 25, 26)	14
3.7 Reset-Generation (JP: 3, 4, 5, 24, 35).....	15
3.8 Buttons INT0, INT1, HST, NMI, Break, Reset (JP: 12, 14, 16, 20, 23, 24)	16
4 PROGRAMMING THE INTERNAL FLASH.....	17
4.1 Fujitsu MB91360 Flash Programmer	17
5 CONNECTORS	19
5.1 Power connector (X12).....	19
5.2 Edge connector (X1, X2)	19
5.3 UART"A", UART"B" (X3, X5)	19
5.4 LIN"A", LIN"B" Interface (X6, X8).....	20
5.5 CAN Interface connector (X10).....	20
5.6 USER-LEDs & LC-Display (optional)	20
5.7 VG96 connector (X4).....	21
6 SILK-PLOT OF THE BOARD	23
7 RELATED PRODUCTS	24
8 INFORMATION IN THE WWW.....	25

1 Overview

1.1 Abstract

The STARTERKIT MB91364 is a low cost multifunctional evaluation board for the Fujitsu 32-Bit Flash microcontroller MB91F364 series.

It can be used stand alone for software development and testing or as a simple target board to work with the emulator system.

The board allows the designer immediately to start with the software development before his own final target system is available.

1.2 Features

- ▶ Supports 32-Bit MB91F364
- ▶ LQFP-120 package can be used (FPT-120P-M21)
- ▶ 9-12V unstabilized external DC power supply
- ▶ 5V internal power supply available
- ▶ In-Circuit serial Flash programming
- ▶ All resources available for evaluation
- ▶ All pins routed to connectors
- ▶ 4 MHz main crystal
- ▶ Two UART Interfaces
- ▶ Two LIN-Transceivers
- ▶ One High-Speed CAN Transceiver
- ▶ 8 User LEDs
- ▶ Reset-, Break-, NMI-Buttons
- ▶ Two buttons configurable for external interrupts
- ▶ 96pin VG connector

The target board will be delivered with the MB91F364 microcontroller.

This microcontroller contains a 'burn-in'-boot loader for programming the flash.

**This board must only be used for test applications
in an evaluation laboratory environment.**

1.3 General Description

The STARTERKIT MB91364 is designed to support the 32Bit MB91F364 microcontroller.

It can be used as a stand alone evaluation board or as a target board for emulator debugger.

The evaluation board supports following package: FPT-120P-M21 (0.50mm, 16mm x 16mm)

By default, the board is supplied with a socketed 4MHz crystal as the main oscillation clock. Using the internal PLL of the μ C, internal clock rates up to 32MHz can be achieved.

Two separate RS232 transceivers are available to connect the on-chip UARTs to the 9-pin D-Sub connectors (X3, X5). The transceivers generate the adequate RS232 levels for the receive (RXD) and transmit (TXD) lines. The DTR line or the RTS line of the connector can be selected by jumpers (JP3, JP4, JP5) to generate a system reset. The RTS signal can be shortcut to CTS using the jumpers JP31 and JP32.

In-circuit-programming (asynchronous) can be done via UART0 (UART"A",X3) using the Burn-In Bootloader of the microcontroller.

UART5 and UART6 are capable for LIN-operation. Two TLE6259 Single Wire LIN-transceivers have been included to drive the bus line in LIN-systems for automotive and industrial applications. UART6 can be connected selectable (JP6, JP8) to a LIN- or RS232-transceiver (X5, X6).

If the board is used as an emulator target board, the microcontroller must be removed from the socket and the corresponding probe cable has to be used:

Probe Cable: **FR360-PROBE-364**

Header Socket: **NQPACK120SD + HQPACK120SD**

All pins of the microcontroller are connected to the edge connectors X1 and X2 and are directly available to the user. Furthermore, the most important signals are available on the VG64 connector (X4).

The on-board voltage regulator allows the user to connect a unregulated DC input voltage between +9V to +12V. In case of any modifications of the board, care should be taken that the total power consumption will not damage the regulator.

There are six push button switches on the board, used for Reset, HST, Break, NMI and two for External Interrupts Int0 and Int1.

Eight user-LEDs are connected via a 1K pull up resistor network to Port PJ. If these LEDs are not required, the resistor network can be removed to disconnect the LEDs and to free the port.

The operating mode of the microcontroller can be selected by the Dip-switch S2.

2 Installation

Carefully remove the board from the shipping carton.

Check first if there are any damages before power on the evaluation board.

For the power supply a DC input voltage of 9V – 12V is recommended. The positive voltage (+) must be connected to the shield, and ground (GND) must be connected to the centre of the connector X12!

After power-on, the green power-on LED (D16) should be on. If the LED does not light switch off the power supply and check the default jumper settings.

By default, the evaluation board is equipped with a MB91F364 and the device has been programmed with a test program. So after power-on a running light for the eight user LEDs can be seen. Furthermore, a welcome string is continuously output with 9600 baud on UART channels (UART"A"). Please use 1:1 cable for PC-connection.

The in-circuit programming allows the user to program it's own application into the Flash-memory. How to program the Flash memory is described in chapter 4.

If the board is used as an emulator target board, switch off the power supply and remove the microcontroller from the socket. Now the probe cable can be mounted into the socket. Take care of pin 1 marking onto the socket and fix the probe cable with screws.

Do not use other probe cable than for LQFP-120 package only!

Connect the probe cable to the emulation pod. Check all DIP-switch-settings of the evaluation board and the emulation pod.

For the power on sequence the emulator system must be switched on first, after that, switch on the evaluation board. Please look at the corresponding user manuals for the emulator how to set up the emulator system. After the power on the 'Reset'-LED of the emulator must be off and the 'Vcc'-LED must be on.

If the Reset LED is still lighting, then check the DIP-switch-settings of the emulator system and the power supply of the evaluation board.

3 Jumpers and Switches

This chapter describes all jumpers and switches which can be modified on the evaluation board. The default setting is shown with a grey shaded area. All jumpers and switches are named directly on the board, so it is very easy to set the jumpers according to the features.

3.1 Jumper Overview

Jumper	Description / Function	Type	Default	Coordinates
JP1	UART A (TXD)	Jumper 2 pol	closed	HJ 21
JP2	UART A (RXD)	Jumper 2 pol	closed	HJ 21
JP3	DTR/RTS	Jumper 3 pol	open	K 27
JP4	RESET UART A/B	Jumper 3 pol	open	J 20
JP5	DTR/RTS	Jumper 3 pol	open	K 22
JP6	UART/LIN B (RXD)	Jumper 3 pol	1-2	HJ 18
JP8	UART/LIN B (TXD)	Jumper 3 pol	1-2	HJ 19
JP9	LIN B enable	Jumper 2 pol	open	G 17
JP10	Master-Mode	Jumper 2 pol	open	J 27
JP11	AVcc	Jumper 2 pol	closed	H 4/5
JP12	SW INT0	Jumper 2 pol	closed	G 21
JP13	AVcc=AVRH	Jumper 2 pol	closed	G 6
JP14	SW INT1	Jumper 2 pol	closed	G 21
JP15	AVss	Jumper 2 pol	closed	H 4/5
JP16	SW HST	Jumper 2 pol	closed	GH 21
JP17	LIN A enable	Jumper 2 pol	open	F 17
JP18	Master-Mode	Jumper 2 pol	open	F 27
JP19	VDDI	Jumper 3 pol	1-2	G 11/12
JP20	SW NMI	Jumper 2 pol	closed	H 21
JP21	LIN A (RXD)	Jumper 2 pol	open	F 17
JP22	LIN A (TXD)	Jumper 2 pol	open	F 17
JP23	SW Break	Jumper 2 pol	closed	H 21
JP24	RESET	Jumper 2 pol	closed	J 23
JP25	CAN A (TXD)	Jumper 2 pol	closed	E 17
JP26	CAN A (RXD)	Jumper 2 pol	closed	E 17
JP29	int/ext VCC	Jumper 3 pol	1-2	E 13/14
JP31	RTS-CTS	Jumper 2 pol	closed	K 27
JP32	RTS-CTS	Jumper 2 pol	closed	K 22
JP33	Pin64	sold-Jumper	open	G 11
JP34	MCU_VCC	Jumper 2pol	closed	E 13
JP35	Reset inverter	Jumper 3 pol	open	H 19/20

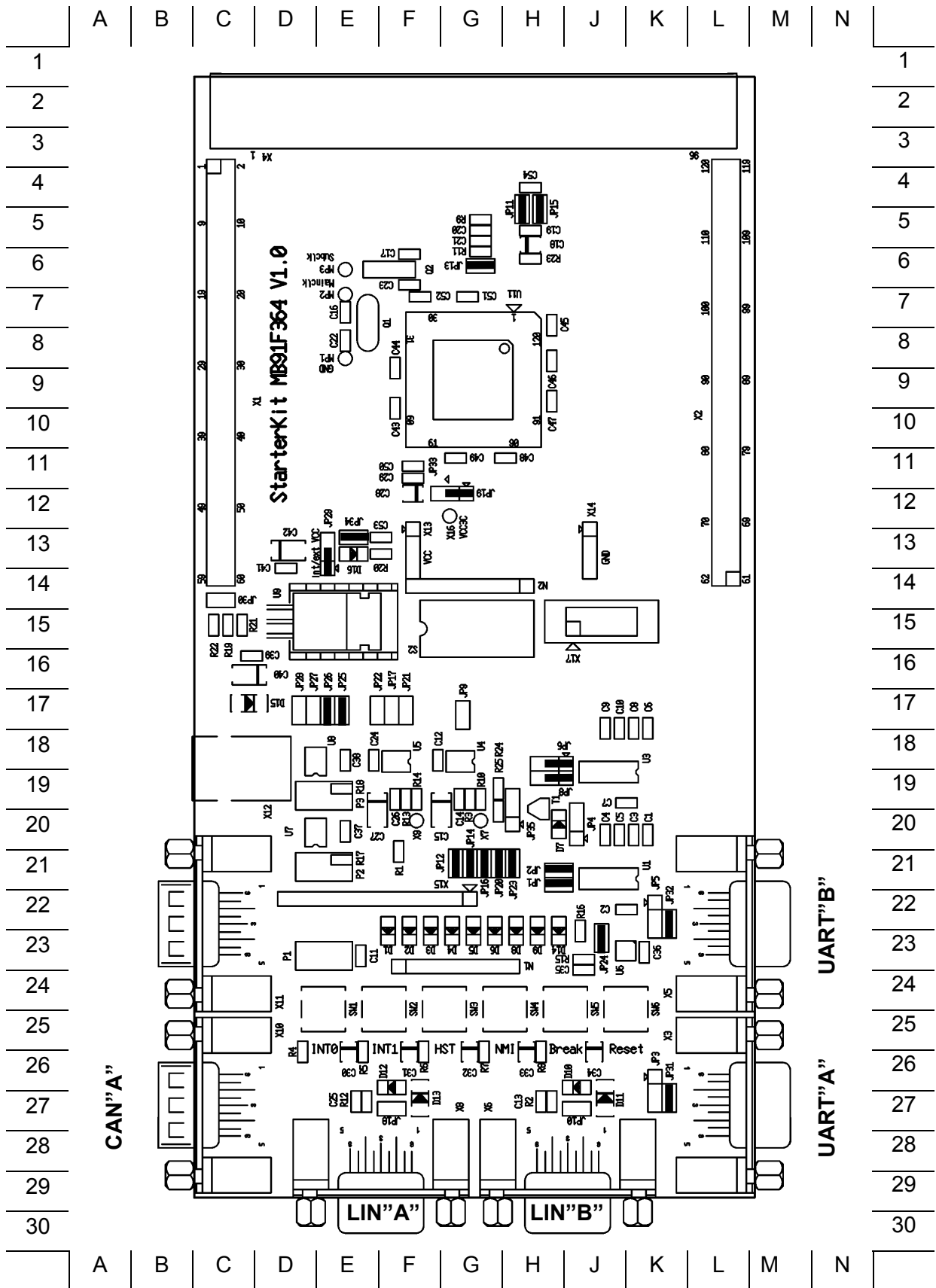

3.2 Operating-Mode (S2)

The DIP-switch S2 is used to set the operating mode of the μ C.

Ensure that the mode pin settings correspond to the operation-mode of the application.

For more detailed information please check the Hardware-Manual of the microcontroller.

DIP switch	Setting	Logical value
S2/1 (MD0)	ON (closed)	0 (low)
	OFF (open)	1 (high)
S2/2 (MD1)	ON (closed)	0 (low)
	OFF (open)	1 (high)
S2/3 (MD2)	ON (closed)	0 (low)
	OFF (open)	1 (high)
S2/4 (SELCLK)	ON (closed)	0 (low)
	OFF (open)	1 (high)
S2/4-8	not connected (all OFF)	

Default: MD0, 1, 2 = 0 0 0, SELCLK = 1

By default, the Single Chip Mode is selected.

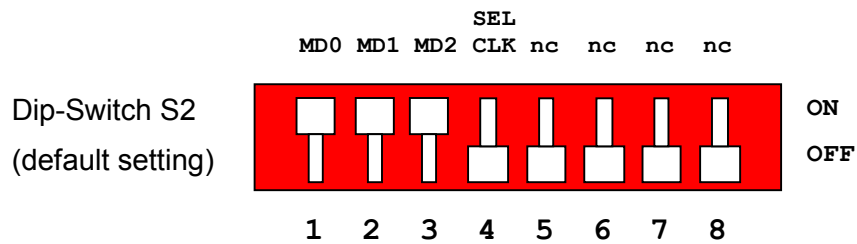

3.3 Power Supply Voltage (JP: 19, 29, 33, 34)

Vcc and GND (Vss) are both connected to the edge-connector (X4) in order to supply additional circuitry. However, if the current requirements exceed the maximum ratings of the on board voltage regulator LM317T, the board also can be powered externally via the edge-connector. But in that case take care of the input-voltage. Neither a voltage regulation nor an over-voltage-protection does exist for an external power-supply.

JP19 VDDI selection (test purposes only)

JP29 Power Supply selection

In case that the board is powered via the VG-connector (X4), a regulated 5V power source has to be used.

JP33 By this solder-Jumper Pin64 of the microcontroller can be connected to ground, in order to improve the EMI behaviour else this pin can be left open.

Note: Do not jumper JP64 if an engineering-sample (MB91F364ES) is used !
The engineering-sample are connected internally to Vcc3C instead of GND (Vss).

JP34 This Jumper is used to connect the Vcc supply voltage to the μ C.
Connecting an Ampere-meter allows measuring of the power-supply-current of the microcontroller (Icc).

Jumper	Setting	Description
JP19 (VDDI)	1 - 2	VDDI is connected to +5V (MCUVcc)
	2 - 3	VDDI is connected to VCC3C (test purposes only)
JP29 (Vcc)	1 - 2	On-board voltage regulation
	2 - 3	External power-supply from X4 pin 1
JP33 (Pin64)	ON (closed)	Pin64 is connected to GND (mass production only)
	OFF (open)	Pin 64 is unconnected (for engineering samples)
JP34 (MCUVcc)	ON (closed)	Power supply Vcc connected to μ C
	OFF (open)	Disconnected from Power supply Vcc

Default: JP19 = 1-2, JP29 = 1-2, JP33 = OFF, JP34 = ON,

By default, the on-board Voltage regulation is used and the microcontroller is powered.

3.4 Analogue Power Supply Voltage (JP: 11, 13, 15)

The MB91F364 has one 12-channel 10-bit A/D-converter.

The power supply as well as the positive reference voltage for the A/D-converter can be provided internally or externally.

JP11, JP15 connect power supply voltages (AVcc and AVss)

JP13 connect reference voltages (AVRH to AVcc)

Jumper	Setting	Description
JP11 (AVcc)	ON (closed)	AVcc is connected to Vcc
	OFF (open)	AVcc is disconnected from Vcc
JP13 (AVRH)	ON (closed)	AVRH is connected to AVcc
	OFF (open)	AVRH defined by resistor network*1
JP15 (AVss)	ON (closed)	AVss is connected to GND
	OFF (open)	AVss is disconnected from GND

*1 By default the resistor network (R11 and R23) is not mounted on the board

Default: JP11, JP13, JP15 are closed

By default, the A/D-converter supply and reference voltage is +5V.

Note:

If JP11 and JP15 are open, the user has to supply an adequate analogue voltage supply (AVcc and AVss) to the A/D-converter.

If JP13 is open, the resistors R11 and R23 define AVRH. By default, the resistor network (R11 and R23) is not mounted on the board.

3.5 RS232- and LIN-Interfaces (JP: 1, 2, 6, 8, 9, 10, 17, 18, 21, 22, 31, 32)

On the MB91F364 three UART-channels are available.

Two of them are capable for LIN-communication.

Two UART-transceivers with RS232 level and two LIN-transceivers are available.

UART0 is dedicated for RS232, UART5 is dedicated for LIN and UART6 can be used for either RS232 or LIN-communication.

UART0 also is used by the Burn-In Bootloader.

Some jumpers interface the μ C to the related transceivers in order to generate the adequate RS232/LIN-levels. If the UART/LIN-interface is not required, the corresponding jumpers should be left open.

3.5.1 UART"A"

JP1, JP2 connects UART0 to the RS232-transceiver (U1, X3)

JP31 Some Flash-programming-Tools needs a connection between CTS and RTS

Jumper	Setting	Description
JP1 (UART"A"TxD)	ON (closed)	SOT0 is connected to RS232-Transceiver
	OFF (open)	SOT0 is disconnected from RS232-Transceiver
JP2 (UART"A"RxD)	ON (closed)	SIN0 is connected to RS232-Transceiver
	OFF (open)	SIN0 is disconnected from RS232-Transceiver
JP31 (RTS-CTS)	ON (closed)	RTS and CTS is shortcut on X3
	OFF (open)	RTS and CTS is not shortcut on X3

Default: JP1=ON, JP2=ON, JP31 = OFF

By default, UART0 of MB91F364 is used as UART"A".

3.5.2 LIN"A"

JP21, JP22 connects UART5 to the LIN-transceiver (U5, X8)

JP17 enable LIN-Transceiver

JP18 LIN Master-mode

Jumper	Setting	Description
JP17 (LIN enable)	open	LIN-transceiver is disabled
	closed	LIN-transceiver is enabled
JP18 (LIN Master)	open	LIN Slave-mode
	closed	LIN Master-mode
JP21 (LIN"A"RXD)	open	SIN5 is disconnected from LIN-Transceiver
	closed	SIN5 is connected to LIN-Transceiver
JP22 (LIN"A"TXD)	open	SOT5 is disconnected from LIN-Transceiver
	closed	SOT5 is connected to LIN-Transceiver

Default: JP17, JP18, JP21, JP22 = open

By default, UART5 of MB91F364 is not used as LIN-interface.

3.5.3 UART" B" / LIN" B"-interface

JP6, JP8 select between UART (U3, X5) or LIN transceiver (U4, X6) for UART6

JP9 enable LIN-Transceiver

JP10 LIN Master-mode

JP32 Some Flash-programming-Tools needs a connection between CTS and RTS

Jumper	Setting	Description
JP6 (RxD)	1 - 2	SIN6 is connected to RS232-Transceiver
	2 - 3	SIN6 is connected to LIN-Transceiver
JP8 (TxD)	1 - 2	SOT6 is connected to RS232-Transceiver
	2 - 3	SOT6 is connected to LIN-Transceiver
JP9 (LIN" B" enable)	open	LIN-transceiver is disabled
	closed	LIN-transceiver is enabled
JP10 (LIN " B" Master)	open	LIN Slave-mode
	closed	LIN Master-mode
JP32 (RTS-CTS)	ON (closed)	RTS and CTS is shortcut on X5
	OFF (open)	RTS and CTS is not shortcut on X5

Default: JP6 = 1-2, JP8 = 1-2, JP9 = open, JP10 = open, JP32 = OFF

By default, UART6 of MB91F364 is used as UART " B".

3.6 CAN Interface (JP: 25, 26)

One high-speed CAN-transceiver is available on the STARTERKIT MB91364.

JP25, JP26 connects the CAN-Port to the CAN-transceiver (U7, X10).

If the CAN interface is not used, the jumpers should be left open.

Jumper	Setting	Description
JP25 (TX0)	Open	TX is disconnected from CAN-Transceiver (U7, X10)
	Closed	TX is connected to CAN-Transceiver (U7, X10)
JP26 (RX0)	Open	RX is disconnected from CAN-Transceiver (U7, X10)
	Closed	RX is connected to CAN-Transceiver (U7, X10)

Default: JP25, JP26 = Closed

By default, the CAN transceiver is connected to the microcontroller

3.7 Reset-Generation (JP: 3, 4, 5, 24, 35)

Additional to the internal Power-On-Reset the microcontroller can be reset by an external Reset-circuit (Voltage-Monitor) and by the UARTs, too.

JP3, JP5 As well the DTR-line as the RTS-Line of UART"A" / UART"B" can be used to generate a system-reset.

JP4 This jumper selects whether the DTR/RTS line from UART"A" or UART"B" will generate a system-reset.

JP24 open this jumper if no external Reset shall be generated.
In this case only the internal reset is active (e.g.: power-on)

JP35 The polarity of the DTR/RTS line can be invert by this jumper.
Remove the jumper in order to disable the reset logic.

Jumper	Setting	Description
JP3 (DTR / RTS "A")	1-2	DTR of UART0 is selected
	2-3	RTS of UART0 is selected
JP4 (UART"A"/"B")	1-2	UART"A" is used to generate Reset
	2-3	UART"B" is used to generate Reset
JP5 (DTR / RTS "B")	1-2	DTR of UART6 is selected
	2-3	RTS of UART6 is selected
JP24 (Main Reset)	closed	external Reset generation is active
	open	no external Reset generation
JP35 (Polarity)	1-2	No polarity inversion for the DTR/RTS signal
	2-3	Polarity inversion for the DTR/RTS signal

Default: JP24 = closed (JP3, JP4, JP5 and JP35 are not set)

By default, the external Reset generation is active. The Reset by UART is disabled.

Note:

While a reset signal is asserted the red Reset-LED D14 is lit.

During normal operation this LED should be off!

If JP35 (Polarity) is set than JP3, JP4 and JP5 have to be set, too.

If the reset LED is steadily on, check the power supply input voltage and the settings for the reset-generation by UART.

3.8 Buttons INT0, INT1, HST, NMI, Break, Reset (JP: 12, 14, 16, 20, 23, 24)

JP12, JP14: Two push buttons can be used to trigger the external interrupts INT0 and INT1

JP16: One button can be used hardware standby

JP20: One Button can be used for non-maskable interrupt

JP23: One Button can be used for break

JP24: One Button can be used for manually reset

Jumper	Setting	Description
JP12 (INT0)	Closed	INT0 of MB91364 is connected to Push-button "INT0"
	Open	no connection to INT0 of MB91364
JP14 (INT1)	Closed	INT1 of MB91364 is connected to Push-button "INT1"
	Open	no connection to INT1 of MB91364
JP16 (HST)	Closed	HSTX of MB91364 is connected to Push-button "HST"
	Open	no connection to HSTX of MB91364
JP20 (NMI)	Closed	NMIX of MB91364 is connected to Push-button "NMI"
	Open	no connection to NMIX of MB91364
JP23 (Break)	Closed	BREAKX of MB91364 is connected to Push-button "Break"
	Open	no connection to BREAKX of MB91364
JP24 (Reset)	Closed	INITX of MB91364 is connected to Push-button "Reset"
	Open	no connection to INTITX of MB91364

Default: JP12, JP14, JP16, JP20, JP23, JP24 = Closed

By default, INT0, INT1, HSTX, NMIX, BREAKX, INITX of the microcontroller are connected to the Push buttons.

4 Programming the internal Flash

The Flash device MB91F364 has an internal bootloader in order to download an user-application. The UART0 (X3) is used for communication with the Front-end-PC-software.

The tool „MB91360 Flash Programmer“ is a general flash programming tool that can be used to program any user-applications to the Flash-ROM of the microcontroller.

Make sure you have installed the Flash Programmer V3.2 or newer from CD-ROM, Disk or from our Web-site. The package includes the executable (Flashprg.exe) as well as some binary files (Brloadxx.bin) and a user's guide (Flashprg.pdf).

CAUTION :

Take special care not to write anything to the „security vector“ at location 0x0FFEF4.

In that case, the Flash-device can only be re-programmed by an external programmer.

See the hardware manual for more details.

4.1 Fujitsu MB91360 Flash Programmer

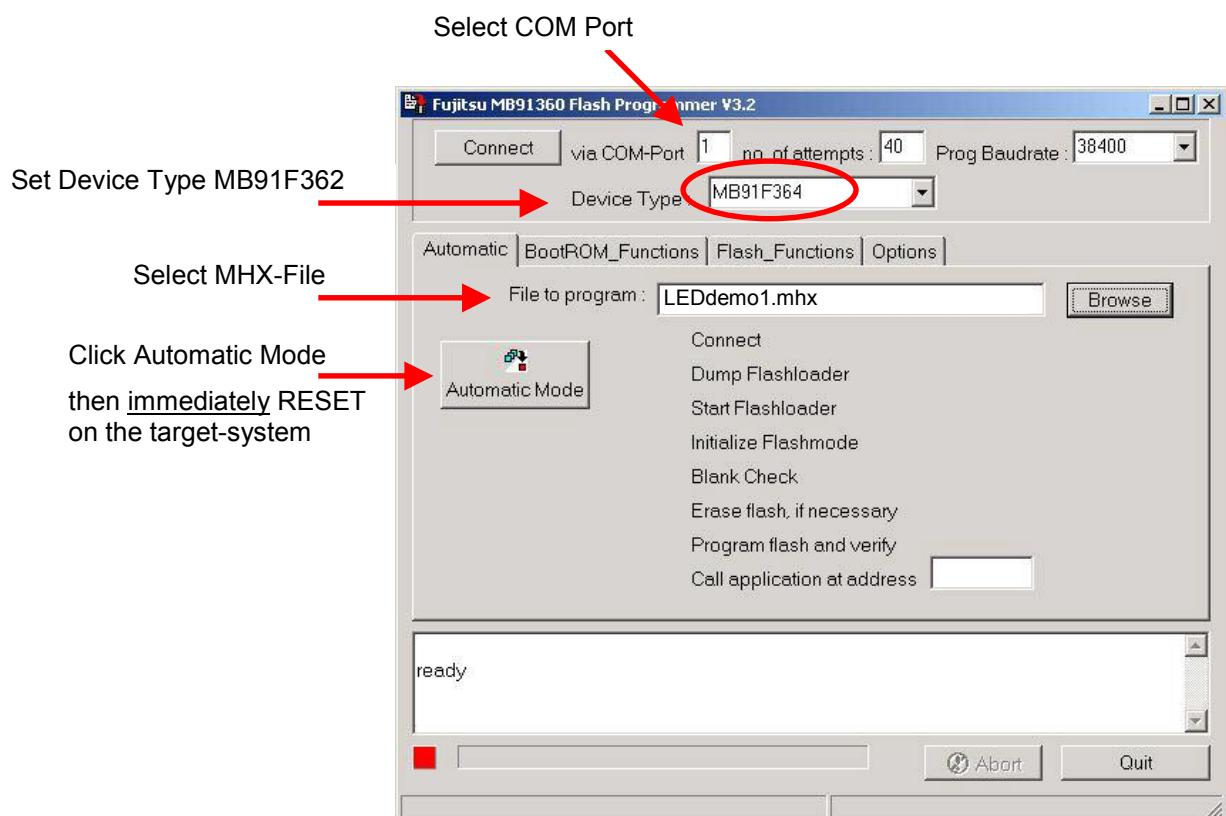

Follow these steps to use the MB91360 Flash Programmer:

1. Power off the board
2. Be sure to have the STARTERKIT in single-chip-mode.
Check the position of the Dip-switch S2:

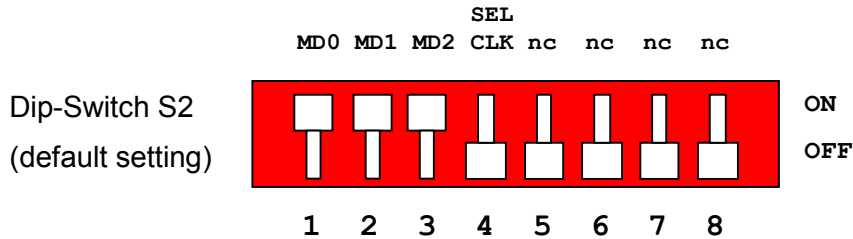

3. Connect the RS232-cable from any PC-COM-port to UART"A".
4. Power on the board
5. Check that the Reset LED is off. Otherwise change the DTR polarity (JP35) and check the power supply voltage.
6. Specify a hex-file in the "file to program"-field. It must be a Motorola™ Hex-File: "* .MHX"
Be sure that you have selected the format-converter within the Softune Workbench in order to get the Motorola™ Hex-File when the project is built.
7. Specify the COM-port and the desired baudrate for programming.
8. Click on **Automatic Mode**
9. Press immediately RESET on the STARTERKIT.
10. The programming sequence will be executed automatically.

**DO NOT INTERRUPT THE FLASH PROGRAMMING !
DO NOT SWITCH OFF THE POWER DURING PROGRAMMING !
Otherwise the FLASH-ROM can be damaged permanently !**

11. After a successful programming procedure, press the reset-button to re-initialise the STARTERKIT and close the Flash Programmer.
12. For more information and trouble shooting, see the „MB91360 Serial flash programmer user's guide“ (Flashprg.pdf) which is included in the installation.

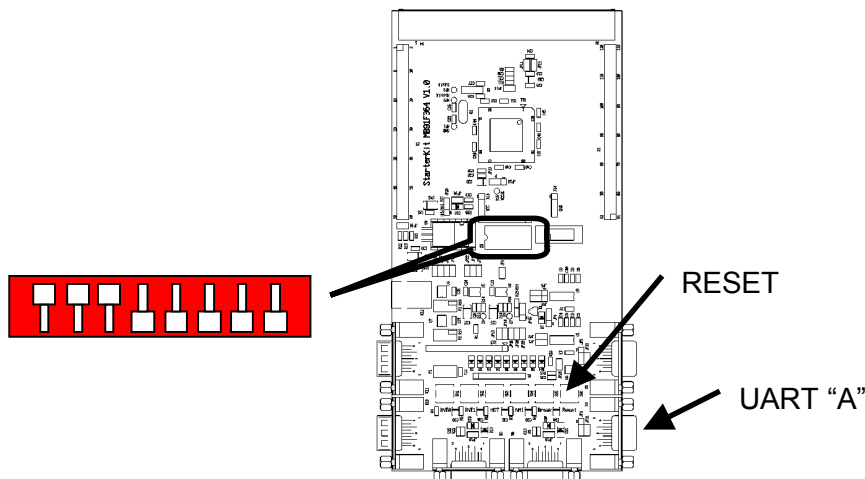

5 Connectors

5.1 Power connector (X12)

The following figure shows the power connection jack X12. This connector is used to connect an external unregulated DC power supply voltage (9V-12V DC) to the evaluation board.

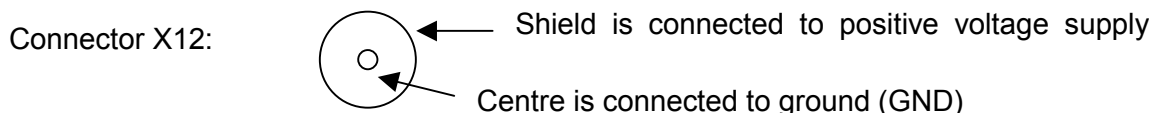

It is recommended to use 9V to keep the power dissipation to a minimum. Otherwise, an additional heat sink for the linear voltage regulator might be necessary.

5.2 Edge connector (X1, X2)

All pins of the microcontroller (LQFP-120 package) are directly connected to X1 and X2, both are 2 x 30 Pin headers, as follows:

Connector	MCU Pins
X1 (1 – 60)	1 – 60
X2 (61 – 120)	61 – 120

The odd pin numbers are located on the one side and the even pin numbers are located on the other side of the connector.

On the PCB, the corresponding pin numbers of the μ C are written next to the connector pins.

5.3 UART"A", UART"B" (X3, X5)

Two 9-pin D-Sub female connectors are used for the serial interfaces UART"A" and UART"B".

TXD is the transmit output, RXD is the receive input.

The DTR signal can be used to generate a reset.

Please use 1:1 cable for PC-connection.

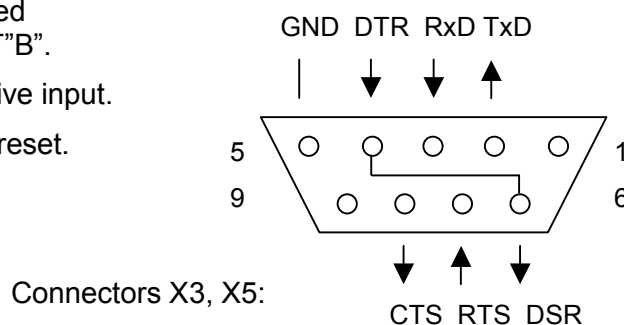

5.4 LIN"A", LIN"B" Interface (X6, X8)

Two 9-pin D-Sub female connectors are used for the LIN-communication.

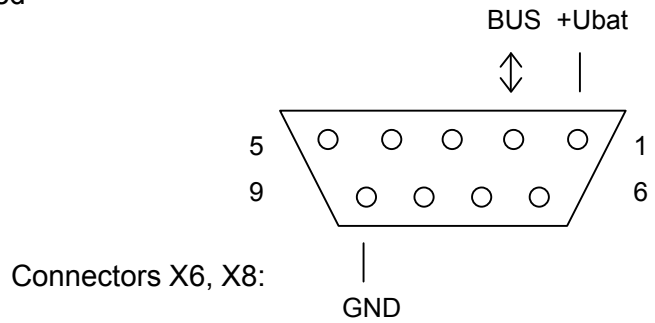

5.5 CAN Interface connector (X10)

One 9-pin D-Sub male connector is used for the CAN interface.

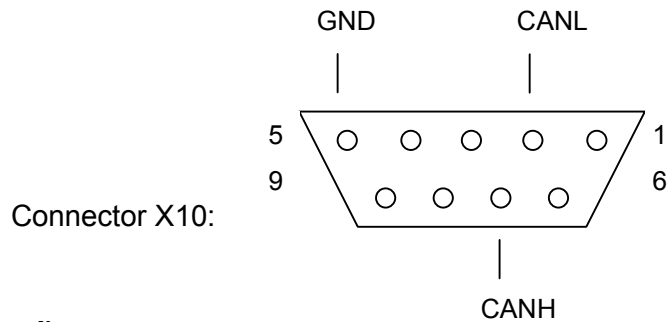

5.6 USER-LEDs & LC-Display (optional)

Eight LEDs are reserved for user-application. In order to disconnect the LEDs from the related microcontroller port, the resistor network N1 can be removed.

Instead of the user-LEDs one alphanumeric LC-Display (optional) can be connected.

The following control-signals are reserved:

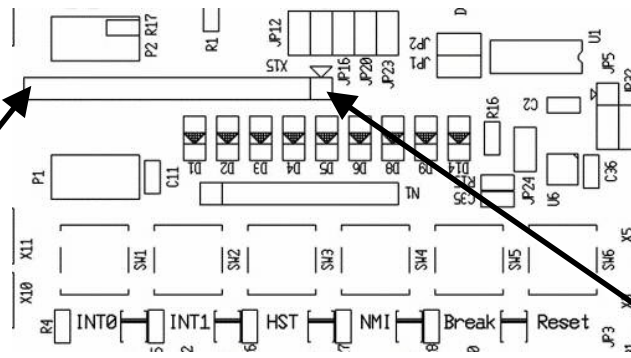

	14	13	12	11	10	9	8	7	6	5	4	3	2	1
LCD	D6	D5	D4	D3	-	-	-	-	E	R/W	RS	V0	VCC	GND
LED	D9	D8	D6	D5				D4	D3	D2	D1			
MCU	110	109	108	107				105	104	103	102			
Port	PJ7	PJ6	PJ5	PJ4				PJ3	PJ2	PJ1	PJ0			

5.7 VG96 connector (X4)

Connector-Pin cross reference table for MB91F364:

MB91364	Description	VG (X4)
1	AN0, PH0	A7
2	AN1, PH1	B7
3	AN2, PH2	C7
4	AN3, PH3	A8
5	AN4, PH4	B8
6	AN5, PH5	C8
7	AVSS,AVRL	n.c.
8	AVRH	n.c.
9	AVCC	n.c.
10	AN6, PH6	A9
11	AN7, PH7	B9
12	AN8, PG0	C9
13	AN9, PG1	A10
14	AN10, PG2	B10
15	AN11, PG3	C10
16	VSS	A6,B6,C6
17	VDD	A2,B2,C2
18	SDA, PM2	A11
19	SCL, PM3	B11
20	SOT0, PQ1	C11
21	SIN0, PQ0	A12
22	HSTX	B12
23	NMIX	C12
24	SELCLK,	A13
25	VDD	A2,B2,C2
26	MONCLK	B13
27	VSS	A6,B6,C6
28	X1A	n.c.
29	X0A	n.c.
30	VDD	A2,B2,C2

MB91364	Description	VG (X4)
31	X1	n.c.
32	X0	n.c.
33	VSS	A6,B6,C6
34	INT0, PK0	C13
35	INT1, PK1	A14
36	INT2, PK2	B14
37	INT3, PK3	C14
38	INT4, PK4	A15
39	INT5, PK5	B15
40	INT6, PK6	C15
41	INT7, PK7	A16
42	VDD	A2,B2,C2
43	VSS	A6,B6,C6
44	IN0, PL0	B16
45	IN1, PL1	C16
46	IN2, PL2	A17
47	IN3, PL3	B17
48	OUT0, PL4	C17
49	OUT1, PL5	A18
50	OUT2, PL6	B18
51	OUT3, PL7	C18
52	VDD	A2,B2,C2
53	VSS	A6,B6,C6
54	TESTX	n.c.
55	CPUTESTX	n.c.
56	ATGX	A19
57	MD0	n.c.
58	MD1	n.c.
59	MD2	n.c.
60	INITX	B19

MB91364	Description	VG (X4)
61	VDD	A2,B2,C2
62	VCC3C	n.c.
63	VCC3C	n.c.
64	Vss (note: Eng.-samples will have VCC3C here)	n.c.
65	VDDI	n.c.
66	VDDI	n.c.
67	VDDI	n.c.
68	BREAKX	C19
69	VDD	A2,B2,C2
70	VSS	A6,B6,C6
71	RX0, PP1	A20
72	TX0, PP0	B20
73	OCPA0, PO0	C20
74	OCPA1, PO1	A21
75	OCPA2, PO2	B21
76	OCPA3, PO3	C21
77	VSS	A6,B6,C6
78	SIN5, PT0	A22
79	SCK5, PT1	B22
80	SOT5, PT2	C22
81	SOT6, PT3	A23
82	SCK6, PT4	B23
83	SIN6, PT5	C23
84	VDD	A2,B2,C2
85	VSS	A6,B6,C6
86	SIN3, PN3	A24
87	SOT3, PN4	B24
88	SCK3, PN5	C24
89	VSS	A6,B6,C6
90	LTESTX	n.c.

MB91364	Description	VG (X4)
91	VDD	A2,B2,C2
92	PR0, PR0	A25
93	PR1, PR1	B25
94	PR2, PR2	C25
95	PR3, PR3	A26
96	PR4, PR4	B26
97	PR5, PR5	C26
98	PR6, PR6	A27
99	PR7, PR7	B27
100	VSS	A6,B6,C6
101	VDD	A2,B2,C2
102	LED0, PJ0	C27
103	LED1, PJ1	A28
104	LED2, PJ2	B28
105	LED3, PJ3	C28
106	VSS	A6,B6,C6
107	LED4, PJ4	A29
108	LED5, PJ5	B29
109	LED6, PJ6	C29
110	LED7, PJ7	A30
111	VSS	A6,B6,C6
112	VDD	A2,B2,C2
113	PO4, PO4	B30
114	PO5, PO5	C30
115	PO6, PO6	A31
116	PO7, PO7	B31
117	PP2/DA0, PP2	C32
118	PP3/DA1, PP3	A32
119	VSS	A6,B6,C6
120	VDD	A2,B2,C2
n.c.	ext. Power +5V	ABC1

6 Silk-Plot of the Board

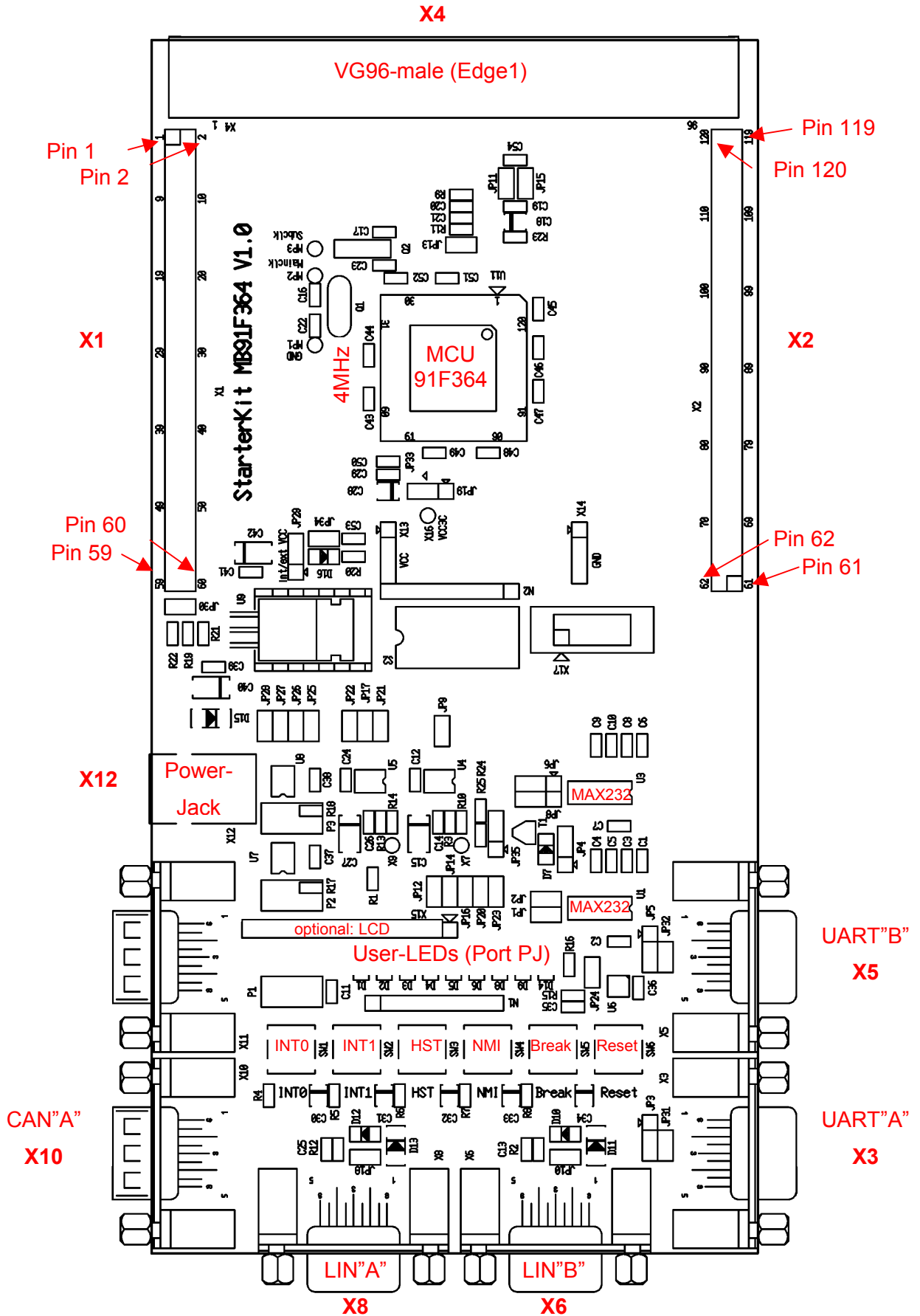

7 Related Products

- ▶ STARTERKIT MB91364 Evaluation board for MB91F364

- ▶ MB2197-01 Emulator debugger main unit

- ▶ MB2197-120 Emulation adapter for MB91360series

- ▶ FR360-PROBE-364 Emulator probe cable for package (FPT-120P-M21)

- ▶ MB91FV360GA-CR Evaluation chip for MB90360series for Emulator

- ▶ MB91F364 Flash-Microcontroller (package FPT-120P-M21)

- ▶ NQPACK120SD Socket for package FPT-120P-M21
(Tokyo Eletech Corp. www.tetc.co.jp/e_tet.htm)

- ▶ HQPACK120SD Header for NQPACK120SD

8 Information in the WWW

Information about FUJITSU MICROELECTRONICS Products can be found on the following Internet pages:

Microcontrollers (8-, 16- and 32bit), Graphics Controllers
Datasheets and Hardware Manuals, Support Tools (Hard- and Software)

<http://www.fme.gsdc.de/gsd.htm>

Memory products: Flash, SDRAM and FRAM

<http://www.fme.fujitsu.com/products/memory/index1.html>

Linear Products: Power Management, A/D and D/A Converters

<http://www.fme.fujitsu.com/products/linear/start.html>

Media Products: SAW filters, acoustic resonators and VCOs

<http://www.fme.fujitsu.com/products/media/index1.html>

For more information about FUJITSU MICROELECTRONICS

<http://www.fme.fujitsu.com/products/start.html>