



CERAMIC

# Low Pass Filter

## LFCN-400D+

50Ω DC to 400 MHz

### FEATURES

- Excellent power handling, 8.5W
- Small size
- 7 sections
- Temperature stable
- LTCC construction
- Protected by U.S Patent 6,943,646



Generic photo used for illustration purposes only

CASE STYLE: FV1206

### APPLICATIONS

- Harmonic rejection
- VHF/UHF transmitters/receivers

**+RoHS Compliant**

The +Suffix identifies RoHS Compliance. See our web site for RoHS Compliance methodologies and qualifications

### ELECTRICAL SPECIFICATIONS<sup>1,2</sup> AT 25°C

Parameter	F#	Frequency (MHz)	Min.	Typ.	Max.	Units	
Passband	Insertion Loss	DC-F1	DC-400	—	—	1.0	dB
	Freq. Cut-Off	F2	560	—	3.0	—	dB
	VSWR	DC-F1	DC-400	—	1.2	—	:1
Stop Band	Rejection Loss	F3	700	20	—	—	dB
		F4-F5	720-3000	—	30	—	
	VSWR	F6	5500	—	20	—	:1
		F3-F6	700-5500	—	20	—	

1. DC Resistance to ground is 100 Mohms min.

2. Measured on Mini-Circuits Characterization Test Board TB-270.

### MAXIMUM RATINGS

Parameter	Ratings
Operating temperature	-55°C to 100°C
Storage temperature	-55°C to 100°C
RF Power Input <sup>3</sup>	8.5 W max. at 25°C
Max. DC Voltage at pins 1&3	25 VDC
DC Current Input to Output	0.5A max. at 25°C

3. Derate linearly to 3.5W at 100°C ambient.

Permanent damage may occur if any of these limits are exceeded.

### TYPICAL FREQUENCY RESPONSE

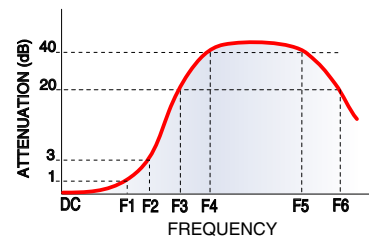

### FUNCTIONAL SCHEMATIC

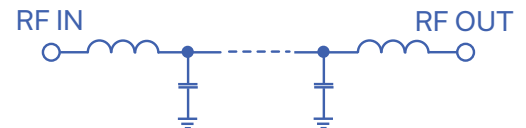

REV. N  
ECO-011331  
LFCN-400D+  
RVN/AD/CP/AM  
120121





### PIN CONNECTIONS

RF IN	1
RF OUT	3
GROUND	2,4

PRODUCT MARKING: N/A

DEMO BOARD MCL P/N: TB-270  
SUGGESTED PCB LAYOUT (PL-137)

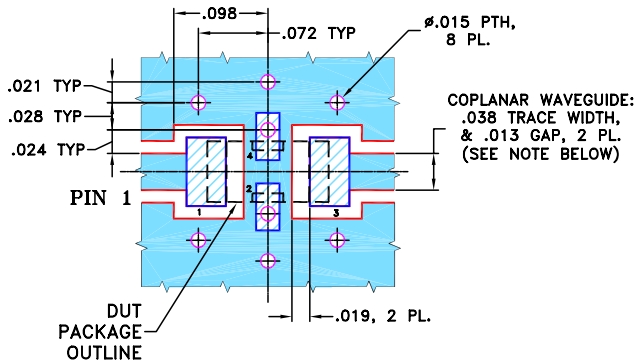

- NOTES:**
1. COPLANAR WAVEGUIDE PARAMETERS ARE SHOWN FOR ROGERS RO4350B WITH THICKNESS .020" ± .0015". COPPER: 1/2 OZ. EACH SIDE. FOR OTHER MATERIALS TRACE WIDTH & GAP MAY NEED TO BE MODIFIED.
  2. BOTTOM SIDE OF THE PCB IS CONTINUOUS GROUND PLANE.

- DENOTES PCB COPPER LAYOUT WITH SMOBC (SOLDER MASK OVER BARE COPPER)
- DENOTES COPPER LAND PATTERN FREE OF SOLDER MASK

### OUTLINE DRAWING

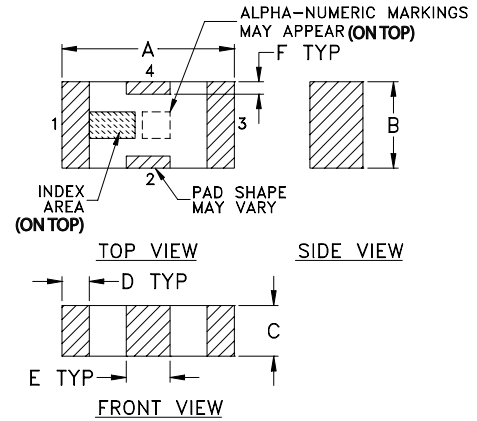

### PCB Land Pattern

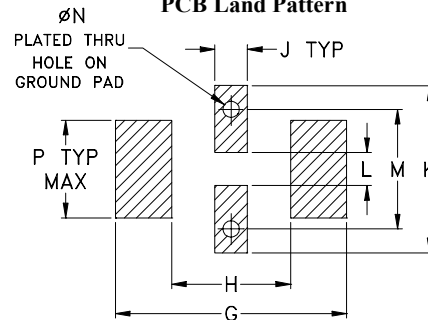

Suggested Layout,  
Tolerance to be within ±.002

### OUTLINE DIMENSIONS (Inches mm)

A	B	C	D	E	F	G	
.126	.063	.037	.020	.032	.009	.169	
3.20	1.60	0.94	0.51	0.81	0.23	4.29	
H	J	K	L	M	N	P	wt
.087	.024	.122	.024	.087	.012	.071	grams
2.21	0.61	3.10	0.61	2.21	0.30	1.80	.020

TAPE & REEL INFORMATION: F71



CERAMIC

# Low Pass Filter

## LFCN-400D+

### TYPICAL PERFORMANCE DATA AT 25°C

Frequency (MHz)	Insertion Loss (dB)	VSWR (:1)
1.00	0.11	1.03
100.00	0.28	1.05
210.00	0.43	1.04
300.00	0.58	1.03
400.00	0.86	1.19
560.00	4.02	2.85
660.00	39.58	14.38
700.00	53.94	16.41
1000.00	34.84	27.16
2000.00	55.00	48.26
3000.00	64.81	48.26
4000.00	24.93	33.42
4500.00	28.21	34.75
5000.00	28.12	34.07
5500.00	25.03	35.46

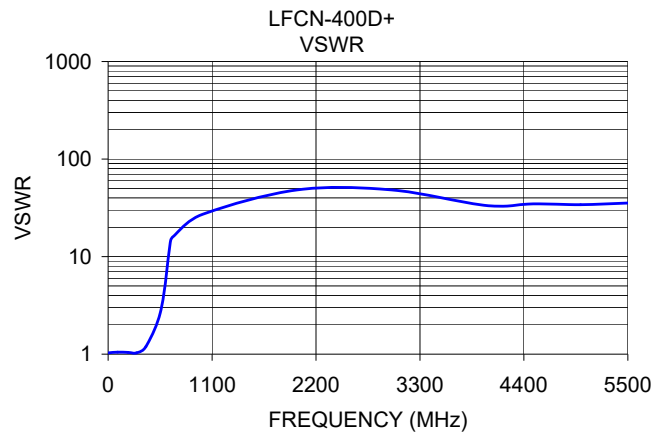
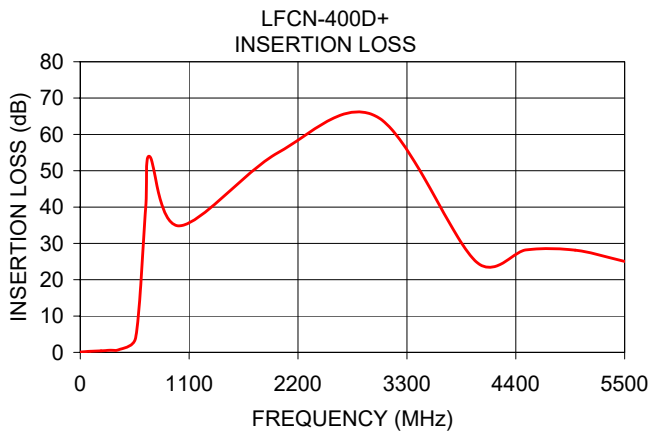

#### NOTES

- A. Performance and quality attributes and conditions not expressly stated in this specification document are intended to be excluded and do not form a part of this specification document.
- B. Electrical specifications and performance data contained in this specification document are based on Mini-Circuit's applicable established test performance criteria and measurement instructions.
- C. The parts covered by this specification document are subject to Mini-Circuits standard limited warranty and terms and conditions (collectively, "Standard Terms"); Purchasers of this part are entitled to the rights and benefits contained therein. For a full statement of the standard. Terms and the exclusive rights and remedies thereunder, please visit Mini-Circuits' website at [www.minicircuits.com/MCLStore/terms.jsp](http://www.minicircuits.com/MCLStore/terms.jsp)

