

Peak Sensitivity Wavelength: 905nm

The MTAPD-07-xxx-905F is a circular ($\Phi 500\mu\text{m}$) .2 mm² active area Avalanche Photodiode with optimized sensitivity at 905nm & housed in a LCC6 SMD package. It is well suited for applications requiring High Speed & Low Noise in visible-near IR applications.

FEATURES

- >Fast Rise Time
- >Ultra Low Noise
- >Low Capacitance
- >High Gain
- >Optimum Gain M100

- >Operating Voltages:
 120v - 160v
 160v - 200v
 Other Voltages Available

APPLICATIONS

- >Optical rangefinders
- >High speed optical communications
- >Medical Equipment
- >Bar Code Readers

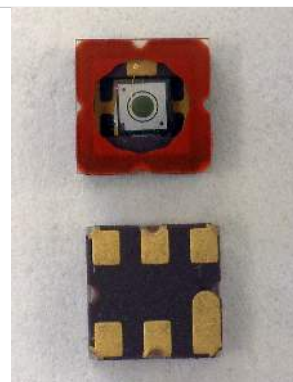

Absolute Maximum Ratings



ITEMS	SYMBOL	RATINGS	UNIT
Storage Temperature	Tstg	-55 ~ +125	°C
Operating Temperature	Topr	-20 ~ +85	°C
Power Dissipation	Pd	1	mw
Forward Current	If	1	mA
Operating Voltage	Vop	0.95 x Vbr	V
Solder Reflow Temperature *1	Stemp	260	°C

*1: Time 5 Sec max

Electrical & Optical Characteristics (Ta=23°C)

ITEMS	SYMBOL	CONDITIONS	MIN.	TYP	MAX.	UNIT
Spectral Response	λ	--		400 - 1100		nm
Active Area		--		Diameter 500		μm
Responsivity	Re	$\lambda=905\text{nm}$, $\varphi_e=1\mu\text{W}$, M=100	50	55	--	A/W
Rise Time	tR	f=1MHz, RL=50 Ω , $\lambda=905\text{nm}$	--	0.6	--	ns
Dark Current	I _D	M=100	0.1	0.4	1.0	nA
Capacitance	Cj	M=100, f=1MHz		1.2		pF
Optimal Gain	M	--		100		
Breakdown Voltage	Vbr	IR=2 μA	80	--	200	V
Temperature Coefficient		Tc=-40°C - 85°C		0.9		V/°C

LCC6 SMD Package Dimensions (6 Pin)

MTAPD-07-015-905F $V_{br}=120-160V$
 MTAPD-07-016-905F $V_{br}=160-200V$

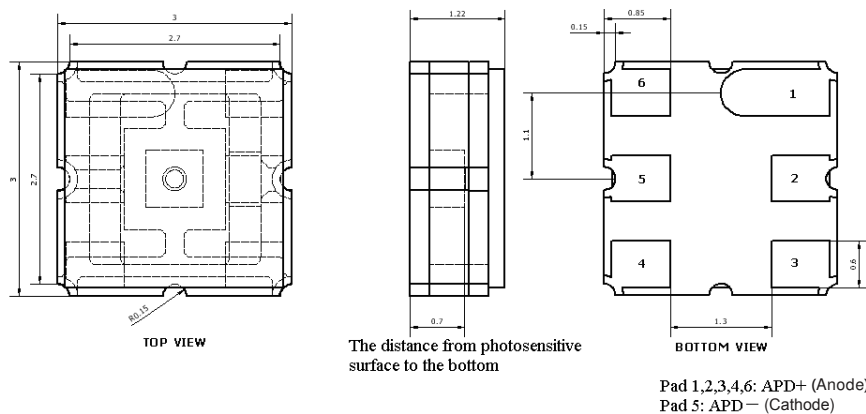

Unit: mm, Tolerance: ± 0.2

Fig 1 Responsivity, Vr=0V

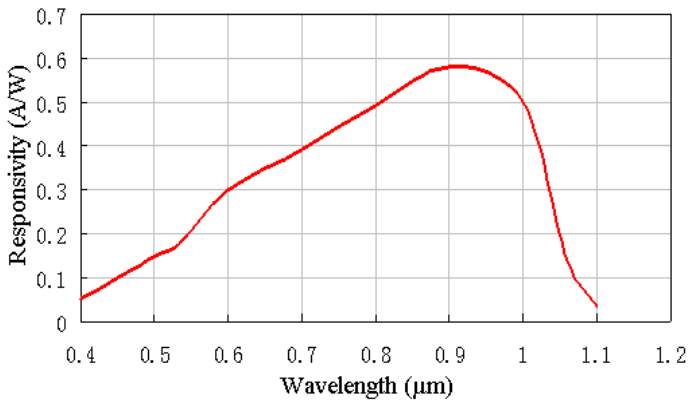

Fig 2 Dark Current

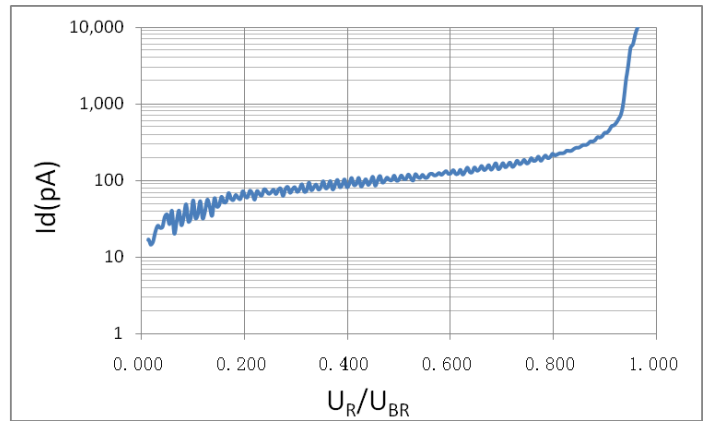

Fig 3 Multiplication

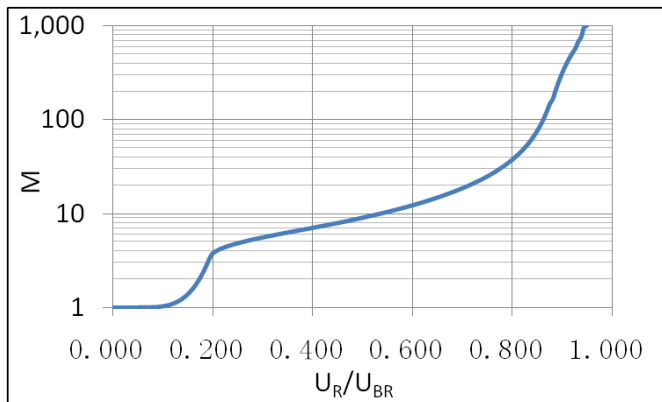
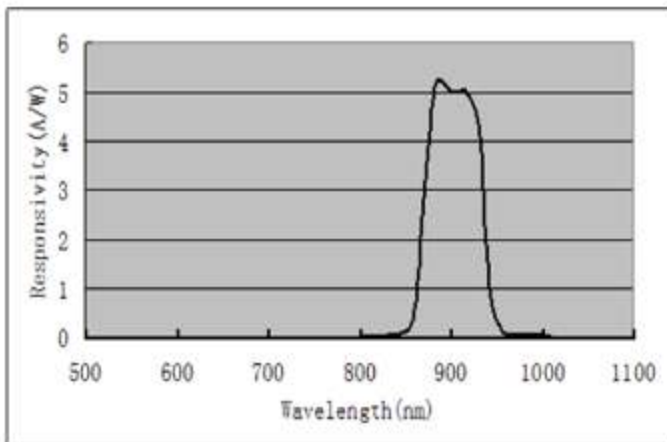

Fig 4 Capacitance



Fig 5 Responsivity,
905nm Optional Filter, M=10



Applications Diagram

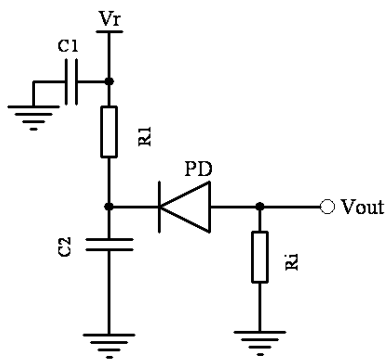

- Notes: C1 - Filter capacitor, filter noise from Vr.
 C2 - bypass capacitor, the loop to ground for AC signal.
 R1 - current-limiting resistor, protect APD from higher voltage.
 Ri - sampling resistor, convert the current signal into a voltage signal.

Equivalent Circuit Diagram

