



MBR2040DC SERIES

20 AMPERES SCHOTTKY BARRIER RECTIFIERS

VOLTAGE 40 to 200 Volt **CURRENT** 20 Ampere

TO-263 / D²PAK

Unit : inch(mm)

FEATURES

- Plastic package has Underwriters Laboratory Flammability Classification 94V-O. Flame Retardant Epoxy Molding Compound.
- Low power loss, high efficiency.
- High current capability
- For use in low voltage, high frequency inverters free wheeling, and polarity protection applications.
- Lead free in compliance with EU RoHS 2.0
- Green molding compound as per IEC 61249 standard

MECHANICAL DATA

- Case: TO-263 / D²PAK molded plastic
- Terminals: solder plated, solderable per MIL-STD-750, Method 2026
- Polarity: As marked.
- Weight: 0.049 ounces, 1.38 grams.

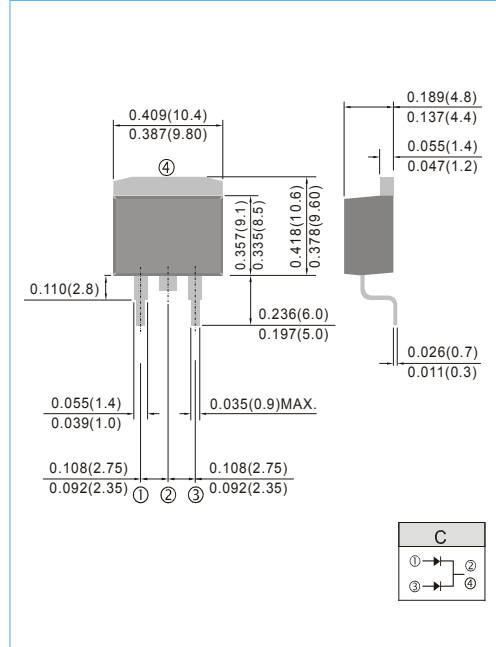

MAXIMUM RATINGS AND ELECTRICAL CHARACTERISTICS

Ratings at 25°C ambient temperature unless otherwise specified. Single phase, half wave, 60 Hz, resistive or inductive load.

For capacitive load, derate current by 20%

| PARAMETER | SYMBOL | MBR2040DC | MBR2045DC | MBR2050DC | MBR2060DC | MBR2080DC | MBR2090DC | MBR20100DC | MBR20150DC | MBR20200DC | UNITS |
|---|-----------------|-----------|-----------|-----------|-----------|-----------|--------------|------------|------------|----------------|-------|
| Maximum Recurrent Peak Reverse Voltage | V_{RRM} | 40 | 45 | 50 | 60 | 80 | 90 | 100 | 150 | 200 | V |
| Maximum RMS Voltage | V_{RMS} | 28 | 31.5 | 35 | 42 | 56 | 63 | 70 | 105 | 140 | V |
| Maximum DC Blocking Voltage | V_{DC} | 40 | 45 | 50 | 60 | 80 | 90 | 100 | 150 | 200 | V |
| Maximum Average Forward Current (See fig.1) | $I_{F(AV)}$ | 20 | | | | | | | | | A |
| Peak Forward Surge Current :8.3ms single half sine-wave superimposed on rated load | I_{FSM} | 200 | | | | | | | | | A |
| Maximum Forward Voltage at 10A, per leg | V_F | 0.7 | 0.75 | | 0.8 | | | 0.9 | | | V |
| Maximum DC Reverse Current at Rated DC Blocking Voltage $T_c=25^\circ C$ $T_c=125^\circ C$ | I_R | | | | | | 0.05 | 20 | | | mA |
| Typical Thermal Resistance | $R_{\theta JC}$ | | | | | | 2 | | | $^\circ C / W$ | |
| Operating Junction Temperature Range | T_J | | | | | | -50 to + 150 | | | $^\circ C$ | |
| Storage Temperature Range | T_{STG} | | | | | | -50 to + 150 | | | $^\circ C$ | |

Notes :

Both Bonding and Chip structure are available.



MBR2040DC SERIES

RATING AND CHARACTERISTIC CURVES

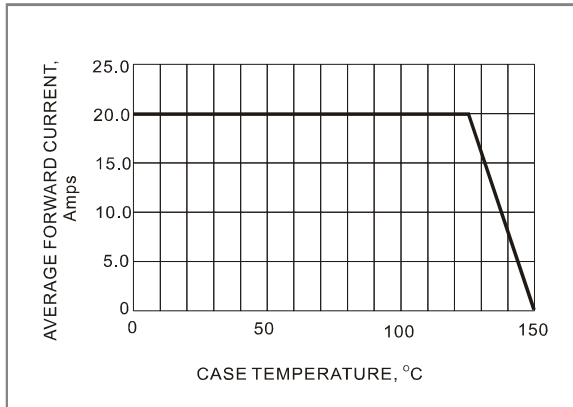

Fig.1- FORWARD CURRENT DERATING CURVE

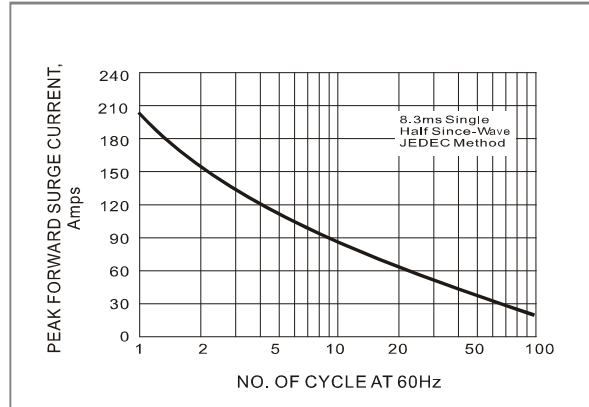

Fig.2- MAXIMUM NON-REPETITIVE SURGE CURRENT

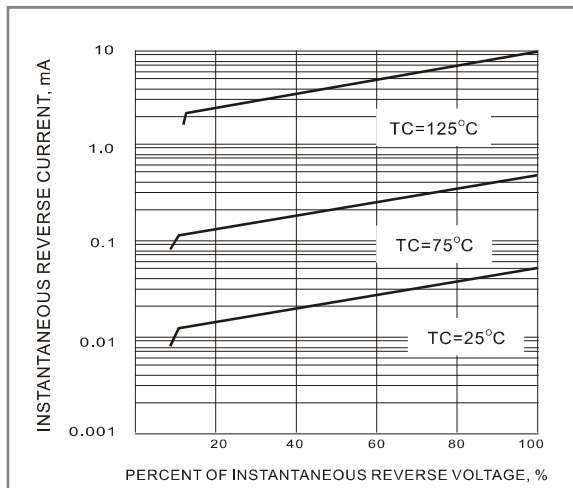

Fig.3- TYPICAL REVERSE CHARACTERISTICS

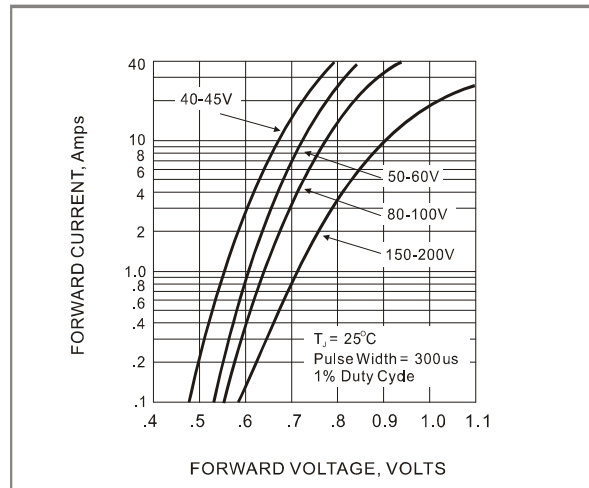

Fig.4- TYPICAL INSTANTANEOUS FORWARD CHARACTERISTICS

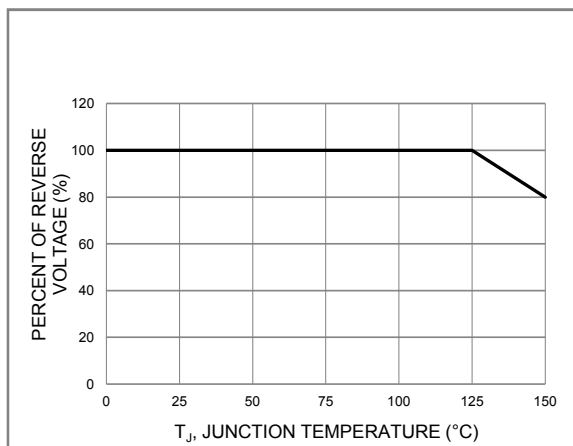
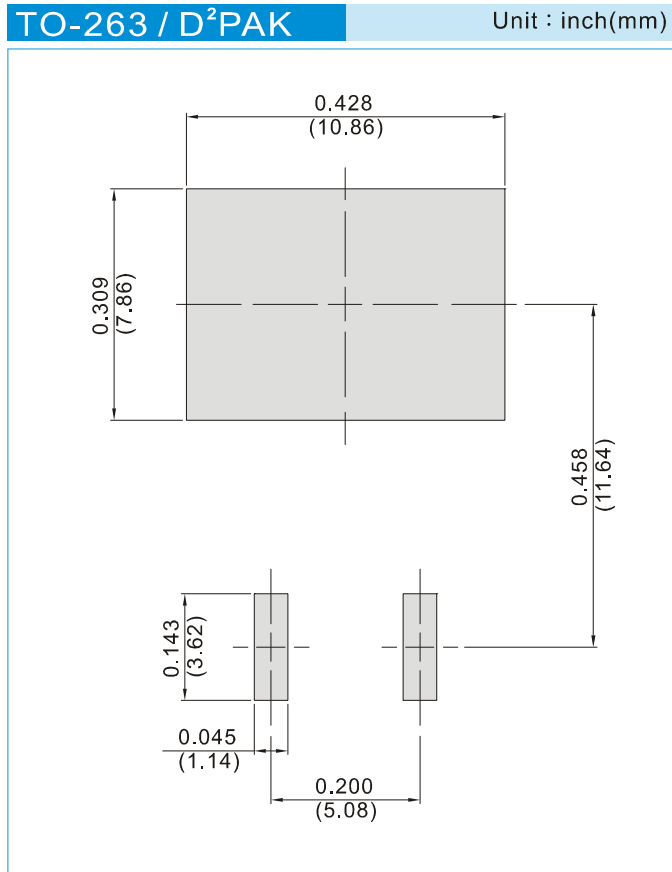

Fig.5- OPERATING TEMPERATURE DERATING CURVE



MBR2040DC SERIES

MOUNTING PAD LAYOUT



ORDER INFORMATION

- Packing information
T/R - 0.8K per 13" plastic Reel



MBR2040DC SERIES

Part No_packing code_Version

MBR2040DC_R2_00001

For example :

RB500V-40_R2_00001



| Packing type | Packing Code XX | | | Version Code XXXXX | | |
|--------------------------------------|------------------------|----------------------------------|----------------------|---------------------------|----------------------|---------------------------------------|
| | 1 st Code | Packing size code | 2 nd Code | HF or RoHS | 1 st Code | 2 nd ~5 th Code |
| Tape and Ammunition Box (T/B) | A | N/A | 0 | HF | 0 | serial number |
| Tape and Reel (T/R) | R | 7" | 1 | RoHS | 1 | serial number |
| Bulk Packing (B/P) | B | 13" | 2 | | | |
| Tube Packing (T/P) | T | 26mm | X | | | |
| Tape and Reel (Right Oriented) (TRR) | S | 52mm | Y | | | |
| Tape and Reel (Left Oriented) (TRL) | L | PANASERT T/B CATHODE UP (PBCU) | U | | | |
| FORMING | F | PANASERT T/B CATHODE DOWN (PBCD) | D | | | |



MBR2040DC SERIES

Disclaimer

- Reproducing and modifying information of the document is prohibited without permission from Panjit International Inc..
- Panjit International Inc. reserves the rights to make changes of the content herein the document anytime without notification. Please refer to our website for the latest document.
- Panjit International Inc. disclaims any and all liability arising out of the application or use of any product including damages incidentally and consequentially occurred.
- Panjit International Inc. does not assume any and all implied warranties, including warranties of fitness for particular purpose, non-infringement and merchantability.
- Applications shown on the herein document are examples of standard use and operation. Customers are responsible in comprehending the suitable use in particular applications. Panjit International Inc. makes no representation or warranty that such applications will be suitable for the specified use without further testing or modification.
- The products shown herein are not designed and authorized for equipments requiring high level of reliability or relating to human life and for any applications concerning life-saving or life-sustaining, such as medical instruments, transportation equipment, aerospace machinery et cetera. Customers using or selling these products for use in such applications do so at their own risk and agree to fully indemnify Panjit International Inc. for any damages resulting from such improper use or sale.
- Since Panjit uses lot number as the tracking base, please provide the lot number for tracking when complaining.