

Features

- Ideal for indication light on hand held products
- Long life and robust package
- Standard Package: 2,000pcs/ Reel
- MSL (Moisture Sensitivity Level): 3
- RoHS compliant



ATTENTION
OBSERVE PRECAUTIONS
FOR HANDLING
ELECTROSTATIC
DISCHARGE
SENSITIVE
DEVICES

Package Schematics

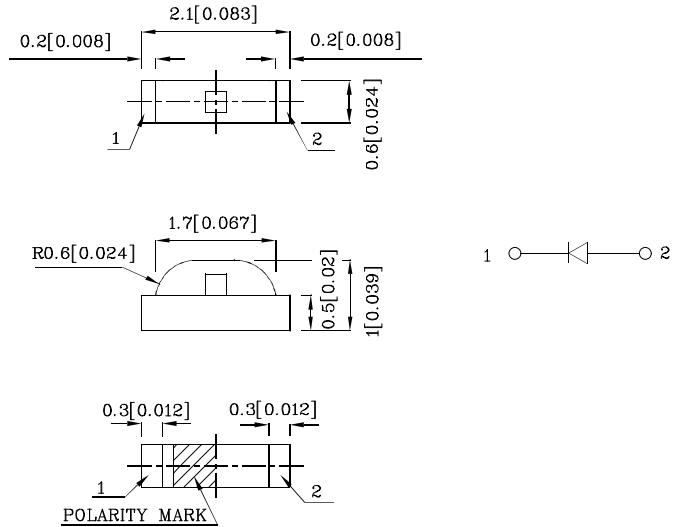

Notes:

1. All dimensions are in millimeters (inches).
2. Tolerance is $\pm 0.1(0.004)$ unless otherwise noted.
3. Specifications are subject to change without notice.

| Absolute Maximum Ratings ($T_A=25^\circ\text{C}$) | | CWD (InGaN) | Unit |
|--|-----------|----------------|------|
| Reverse Voltage | V_R | 5 | V |
| Forward Current | I_F | 30 | mA |
| Forward Current (Peak) 1/10 Duty Cycle 0.1ms Pulse Width | i_{FS} | 150 | mA |
| Power Dissipation | P_D | 120 | mW |
| Operating Temperature | T_A | -40 ~ +85 | °C |
| Storage Temperature | T_{stg} | -40 ~ +85 | |
| Electrostatic Discharge Threshold (HBM) | | 250 | V |

| Operating Characteristics ($T_A=25^\circ\text{C}$) | | CWD (InGaN) | Unit |
|---|-------|----------------|---------------|
| Forward Voltage (Typ.) ($I_F=20\text{mA}$) | V_F | 3.3 | V |
| Forward Voltage (Max.) ($I_F=20\text{mA}$) | V_F | 4 | V |
| Reverse Current (Max.) ($V_R=5\text{V}$) | I_R | 50 | μA |
| Chromaticity Coordinates (Typ.) | x | 0.31 | |
| | y | 0.31 | |
| Capacitance (Typ.) ($V_F=0\text{V}$, $f=1\text{MHz}$) | C | 100 | pF |

| Part Number | Emitting Color | Emitting Material | Lens-color | Luminous Intensity CIE127-2007* ($I_F=20\text{mA}$) mcd | | Viewing Angle 2θ 1/2 |
|-------------|----------------|-------------------|--------------------|--|------|-------------------------|
| | | | | min. | typ. | |
| XZCWD74F | White | InGaN | Yellow Fluorescent | 120* | 178* | 120° |

*Luminous intensity value is in accordance with CIE127-2007 standards.

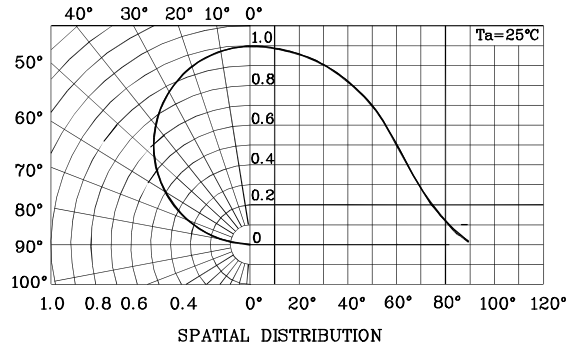

❖ CWD

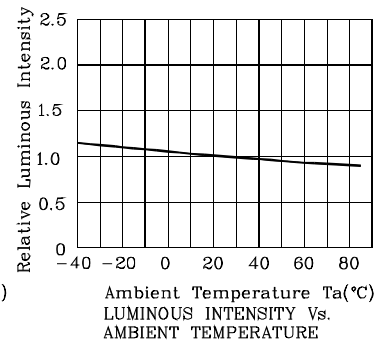
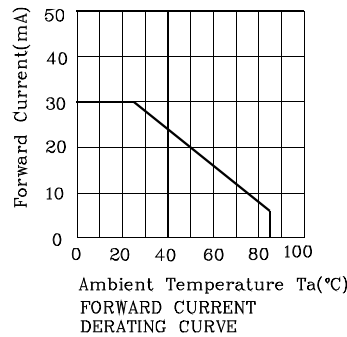
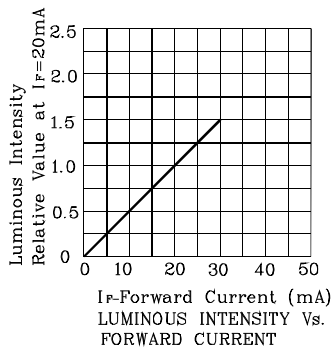
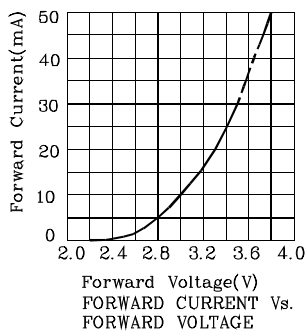

LED is recommended for reflow soldering and soldering profile is shown below.

Reflow Soldering Profile for SMD Products (Pb-Free Components)

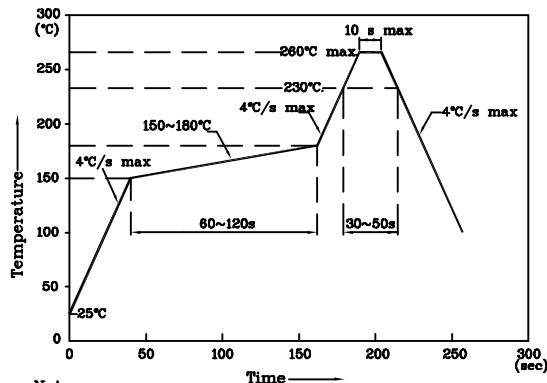

Notes:

1. Maximum soldering temperature should not exceed 280°C
2. Recommended reflow temperature: 145°C-260°C
3. Do not put stress to the epoxy resin during high temperatures conditions

XZCWD74F

White CIE

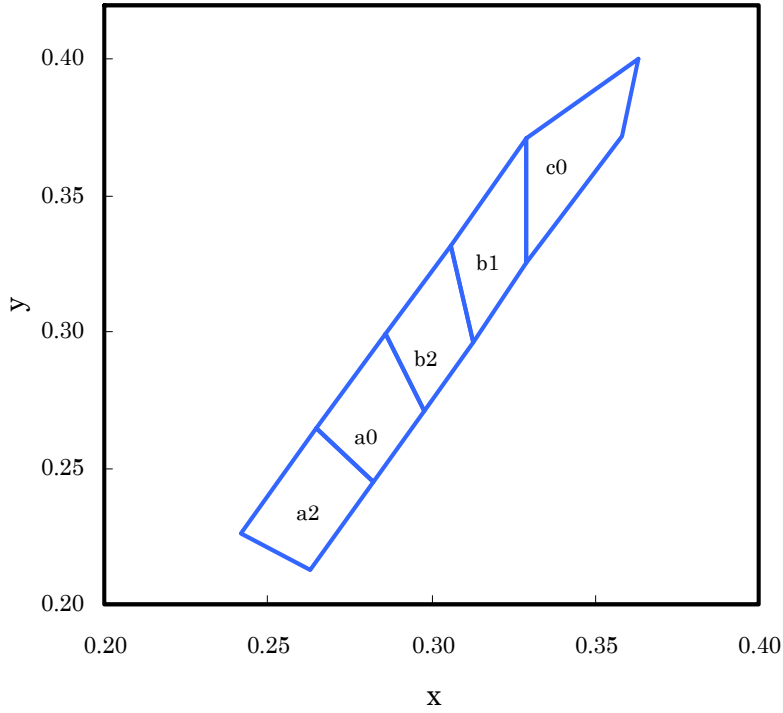

| | x | y | | x | y | | x | y |
|----|-------|-------|----|-------|-------|----|-------|-------|
| a2 | 0.263 | 0.213 | a0 | 0.282 | 0.245 | b2 | 0.298 | 0.271 |
| | 0.282 | 0.245 | | 0.298 | 0.271 | | 0.313 | 0.296 |
| | 0.265 | 0.265 | | 0.286 | 0.299 | | 0.306 | 0.332 |
| | 0.242 | 0.226 | | 0.265 | 0.265 | | 0.286 | 0.299 |
| b1 | 0.313 | 0.296 | c0 | 0.329 | 0.325 | | | |
| | 0.329 | 0.325 | | 0.358 | 0.372 | | | |
| | 0.329 | 0.371 | | 0.363 | 0.400 | | | |
| | 0.306 | 0.332 | | 0.329 | 0.371 | | | |

Notes:
 Shipment may contain more than one chromaticity regions.
 Orders for single chromaticity region are generally not accepted.
 Measurement tolerance of the chromaticity coordinates is ± 0.01 .

❖ The device has a single mounting surface.
The device must be mounted according to the specifications.

❖ Recommended Soldering Pattern
(Units : mm; Tolerance: ± 0.1)

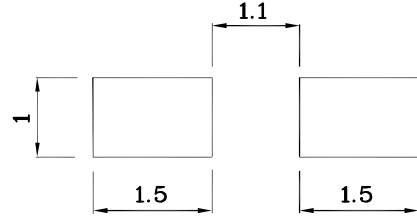
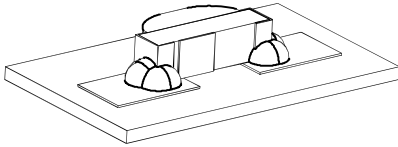

❖ Reel Dimension

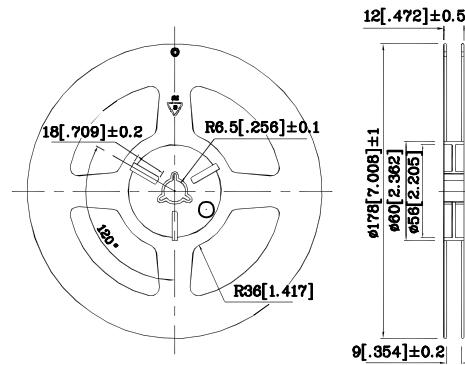

❖ Tape Specification (Units : mm)

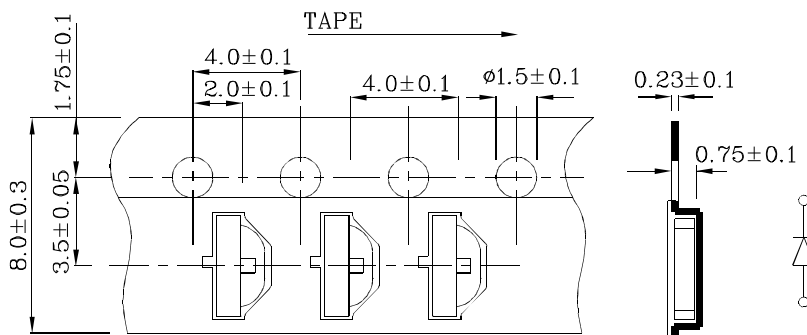

Remarks:



If special sorting is required (e.g. binning based on forward voltage, luminous intensity/ luminous flux or chromaticity), the typical accuracy of the sorting process is as follows:

1. Measurement tolerance of the chromaticity coordinates is ± 0.01 .
2. Luminous Intensity/ Luminous Flux: $\pm 15\%$
3. Forward Voltage: $\pm 0.1V$

Note: Accuracy may depend on the sorting parameters.

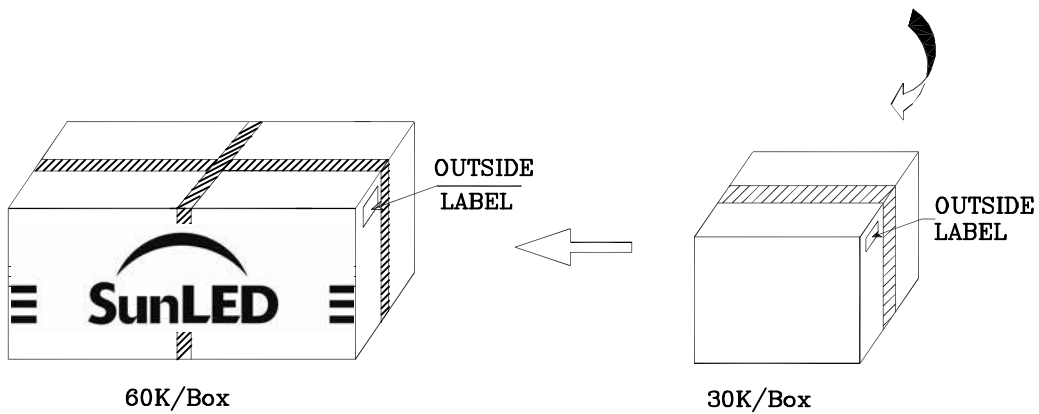
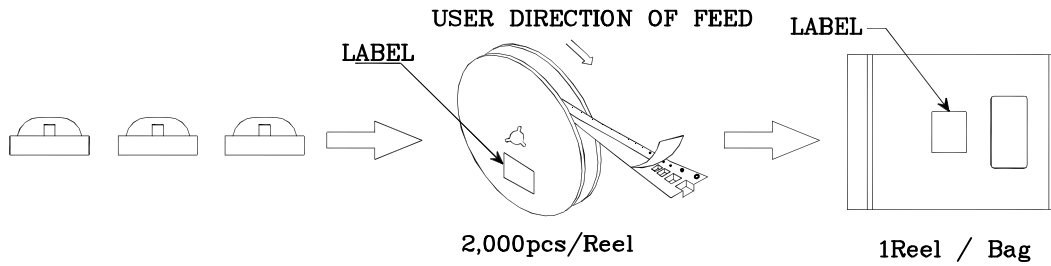
PACKING & LABEL SPECIFICATIONS



| | | |
|--|--|-------------------------------------|
|  | | Q.C. Q C XX XX XXXX PASSED |
| P/NO : XZxxx74x | | |
| QTY : 2,000 pcs | | CODE: XXX |
| S/N : XX | | |
| LOT NO: | | |
|  XXXXXXXXXXXXXXXXXXXXXXXX | | |
| RoHS Compliant | | |

TERMS OF USE

1. Data presented in this document reflect statistical figures and should be treated as technical reference only.
2. Contents within this document are subject to improvement and enhancement changes without notice.
3. The product(s) in this document are designed to be operated within the electrical and environmental specifications indicated on the datasheet.
User accepts full risk and responsibility when operating the product(s) beyond their intended specifications.
4. The product(s) described in this document are intended for electronic applications in which a person's life is not reliant upon the LED. Please consult with a SunLED representative for special applications where the LED may have a direct impact on a person's life.
5. The contents within this document may not be altered without prior consent by SunLED.
6. Additional technical notes are available at <http://www.SunLEDusa.com/TechnicalNotes.asp>