

# TYA-Low Profile High Current SMT Power Inductor

## TYA4020 Series

### FEATURES AND APPLICATIONS

Laird TYA series high current power inductors improve performance, reliability and power efficiency. A lower profile benefits consumer electronics, industrial and telecom design. Products feature extremely low DCR with greater efficiency and enable a large current in a small size. Inductors are of magnetic shielding and wire wound construction and perform in operating temperatures ranging from -40 C to 125 C including self-heating rise in temperature.

#### FEATURES

- Magnetic shielded structure
- Low DCR and high efficiency
- Low profile and small size
- Metal alloy core with high saturation

#### APPLICATIONS

- DC-DC Converter and Power Suppliers
- LCD TV'S and Gaming Console
- Tablet, Notebooks, Servers and Printers
- Networking and Data storage
- GPS, Set-top-box and Base stations
- Smart meters and Medical instruments



#### PART NUMBER EXPLANATION

TYA 4020 4R7 M - 10

|                     |                   |  |                                    |                      |
|---------------------|-------------------|--|------------------------------------|----------------------|
| Product series code | Product size code | Inductance value code<br>(i.e. 4R7: 4.7 $\mu$ H) | Tolerance %<br>(i.e. M: $\pm$ 20%) | Standard Catalog P.N |
|---------------------|-------------------|--|------------------------------------|----------------------|

#### ELECTRICAL SPECIFICATIONS

- Tolerance: M:  $\pm$ 20% or N:  $\pm$ 30%
- Inductance tested at 1MHz, 1.0Vrms
- Heat Rated Current (Irms) is defined based on temperature rise approximate 40°C (ambient temperature 25 $\pm$ 5°C)
- Saturation Current (Isat) is the DC current at which the inductance drops off approximately 30% from its value without current. (ambient temperature 25 $\pm$ 5°C)
- Operating temperature range: -40°C~+125°C (including self-heating temperature rise)
- Storage temperature range (packaging conditions): -10°C~+40°C and RH 70%(MAX.)

**Note:** Heat Rated Current (Irms) is tested on a typical PCB and apply a constant current in still air. The temperature rise is dependent on the application system condition including PCB PAD pattern, trace width and thickness and adjacent components etc. It's suggested to verify the temperature rise of the component under the real operation application conditions.

**SPECIFICATION**

**1.MECHANICAL & DIMENSIONS**

(UNIT: mm)

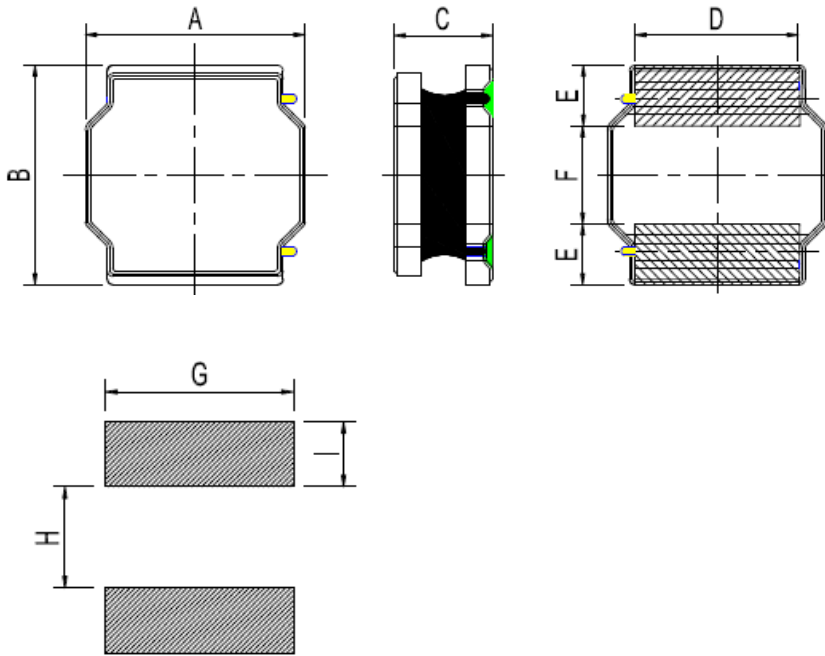

|        |           |
|--------|-----------|
| A      | 4.00±0.30 |
| B      | 4.00±0.30 |
| C      | 2.10 Max  |
| D      | 3.30±0.30 |
| E      | 1.00±0.20 |
| F      | 2.00±0.30 |
| G      | 3.7 REF   |
| H      | 1.9 REF   |
| I      | 1.1 REF   |
| REMARK |           |
|        |           |
|        |           |
|        |           |
|        |           |
|        |           |

**2.PART NUMBER NOMENCLATOR:**

TYA 4020 3R3 M - 10  
**A B C D E**

A: Product Series.

B: Series number, part size

C: Inductance code

D: Inductance Tolerance. (M=±20% ,N=±30%)

E: "X"=0:Standard catalog part number

"X"=1-9:Controlled customized part **or** different performance than std catalog part.

**3.EQUIVALENT CIRCUIT:**

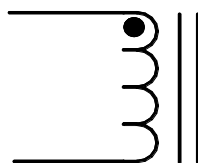

**SPECIFICATION**

| PART NUMBER    | INDUCTANCE (uH) | Irms(A) Typ. | Isat(A) Typ. | DCR(mΩ)Typ | DCR(mΩ) Max |
|----------------|-----------------|--------------|--------------|------------|-------------|
| TYA4020R24M-10 | 0.24            | 6.00         | 14.00        | 13.0       | 17.0        |
| TYA4020R33M-10 | 0.33            | 5.90         | 13.00        | 15.0       | 20.0        |
| TYA4020R47M-10 | 0.47            | 5.90         | 11.00        | 16.0       | 22.0        |
| TYA4020R68M-10 | 0.68            | 5.80         | 9.00         | 19.2       | 24.5        |
| TYA40201R0M-10 | 1.00            | 5.80         | 8.70         | 23.0       | 28.0        |
| TYA40201R5M-10 | 1.50            | 5.20         | 7.70         | 32.0       | 38.0        |
| TYA40202R2M-10 | 2.20            | 4.00         | 6.00         | 46.0       | 56.0        |
| TYA40203R3M-10 | 3.30            | 3.40         | 4.70         | 73.0       | 88.0        |
| TYA40204R7M-10 | 4.70            | 2.85         | 4.00         | 95.0       | 115.0       |
| TYA40206R8M-10 | 6.80            | 2.40         | 3.00         | 130.0      | 160.0       |
| TYA40208R2M-10 | 8.20            | 2.10         | 2.90         | 175.0      | 220.0       |
| TYA4020100M-10 | 10.00           | 2.00         | 2.80         | 190.0      | 220.0       |
| TYA4020150M-10 | 15.00           | 1.00         | 2.10         | 305.0      | 400.0       |
| TYA4020220M-10 | 22.00           | 0.95         | 1.30         | 415.0      | 545.0       |
| TYA4020330M-10 | 33.00           | 0.70         | 1.20         | 650.0      | 850.0       |
| TYA4020470M-10 | 47.00           | 0.56         | 1.10         | 950.0      | 1200.0      |
|                |                 |              |              |            |             |
|                |                 |              |              |            |             |

**GENERAL SPECIFICATION:**

1, Test conditions(L): 1.0MHz, 1Vrms

2, Operating temperature: -40°C to +125°C (Including self-heating)

3, Storage temperature: -10°C to +40°C

4, Humidity range: 70% RH Max.

5, Heat Rated Current (Irms) will cause the coil temperature rise approximately Δt of 40°C

6, Saturation Current (Isat) will cause L0 to drop approximately 30%.

7, Part Temperature (Ambient+Temp. Rise) : Should not exceed 125°C under worst case conditions.

8, Storage condition (component in its packaging)

|  |
|--|
|  |
|  |
|  |
|  |
|  |
|  |

**SPECIFICATION**

**Characteristics Curve**

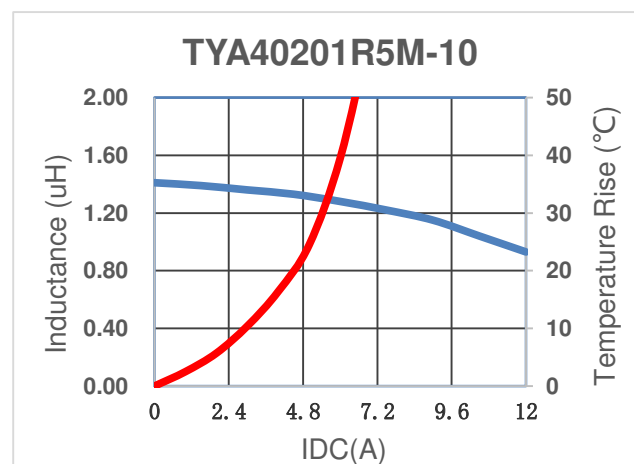
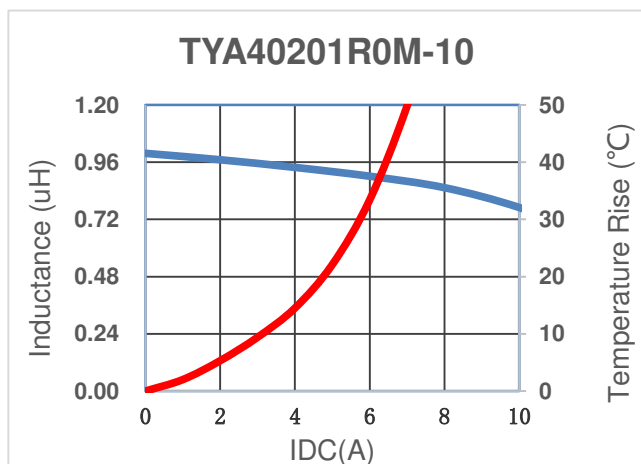
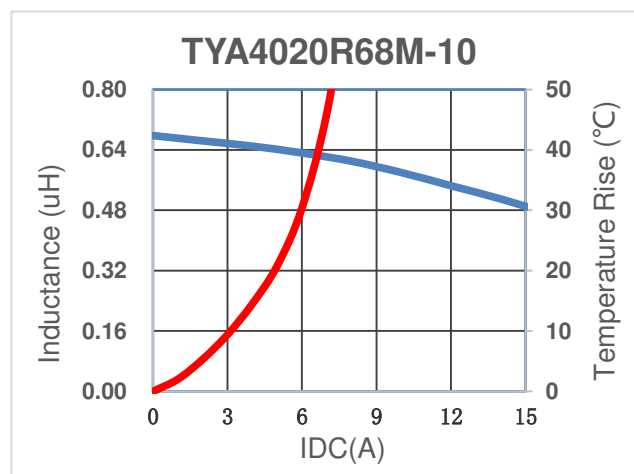
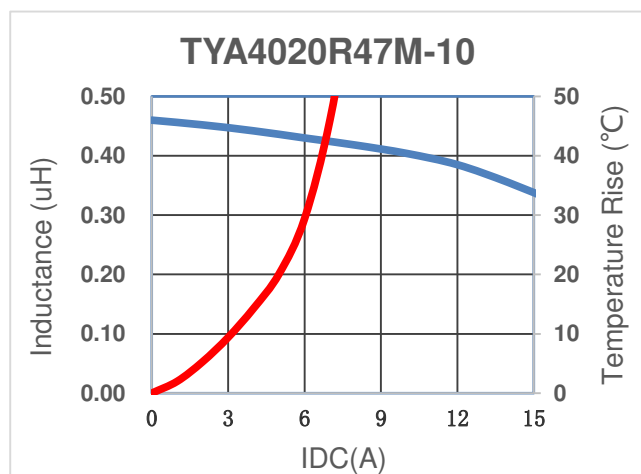
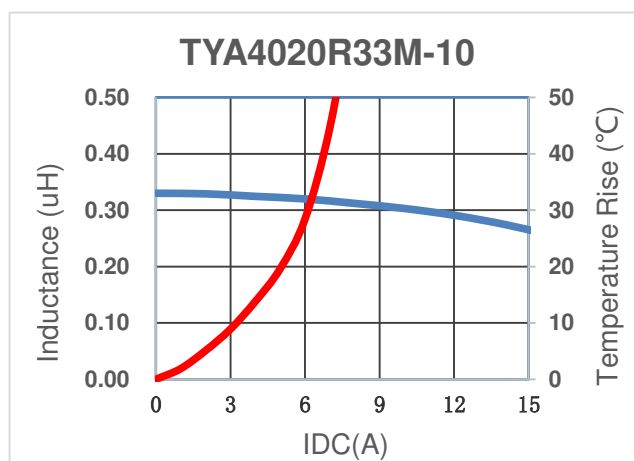
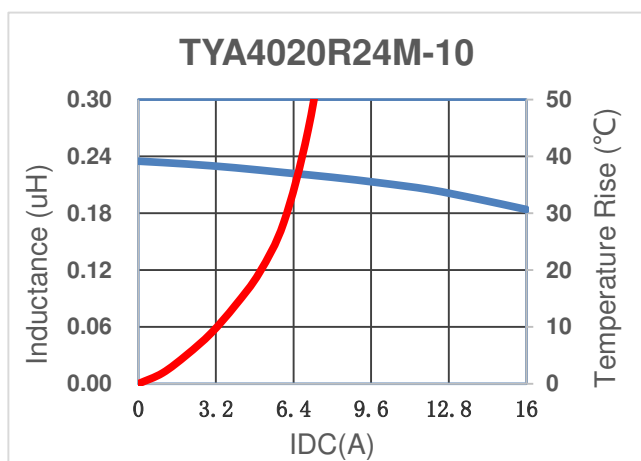

**SPECIFICATION**

**Characteristics Curve**

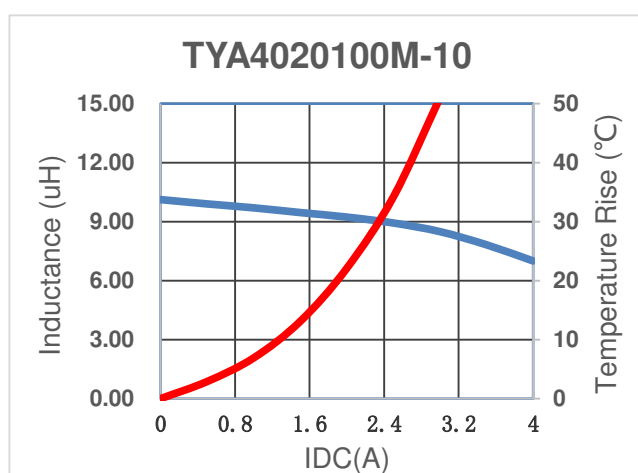
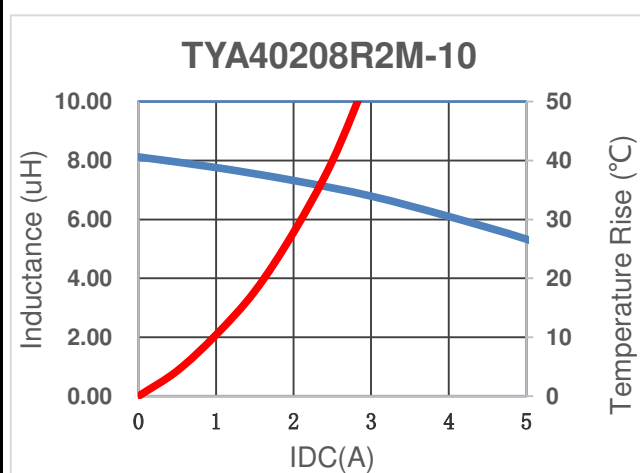
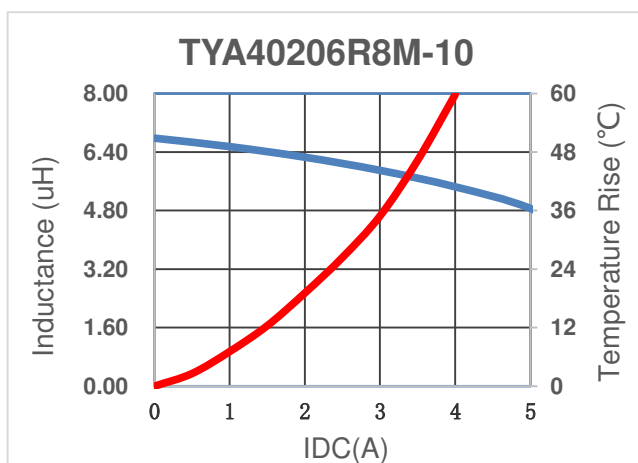
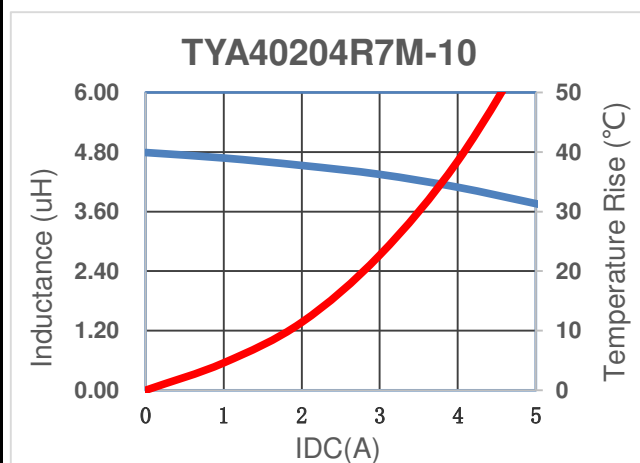
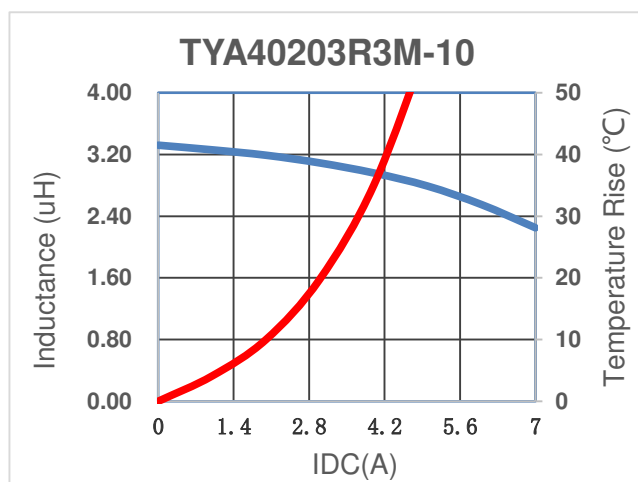
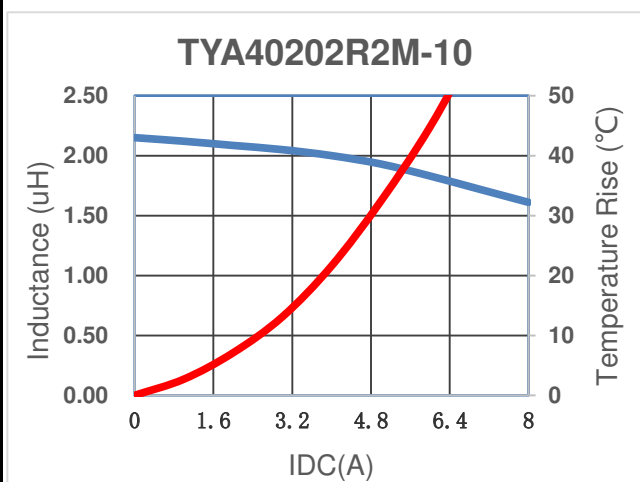

**SPECIFICATION**

**Characteristics Curve**

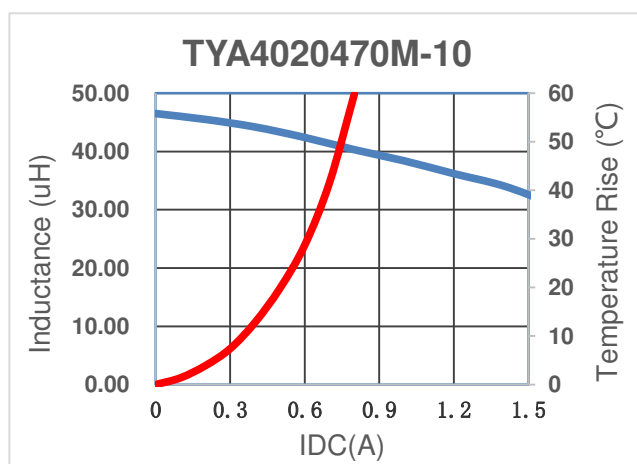
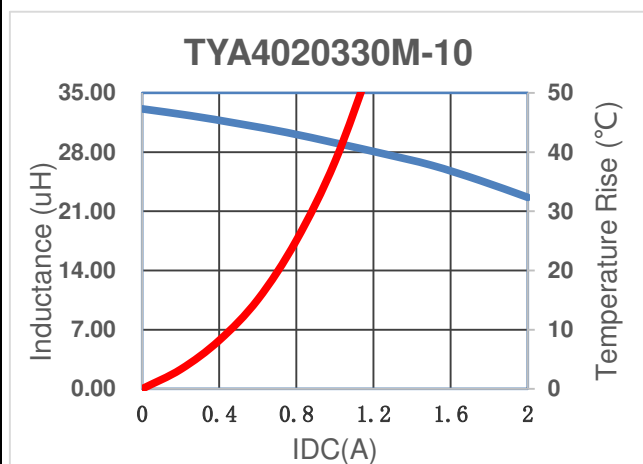
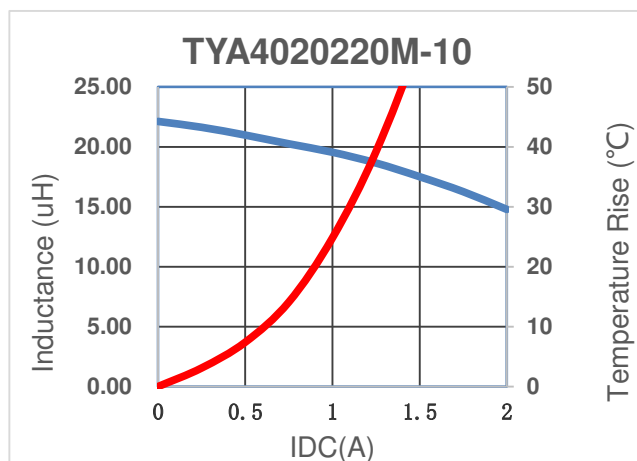
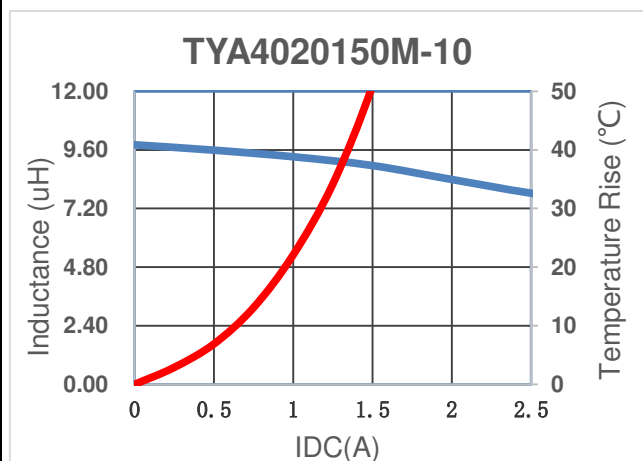

*Recommended Soldering Conditions*

■ For Lead-Free Application

Figure 1 . Re-flow Soldering

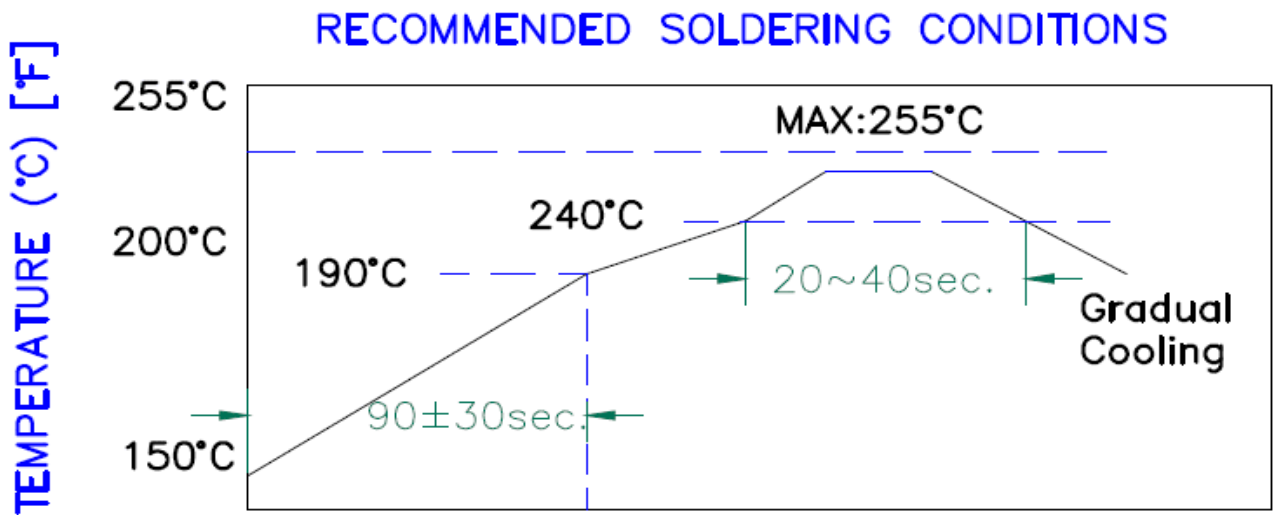

**Reliability and Testing Conditions / Pin Type Power Inductors**

**SMD series(Consumer)**

| Item                                   | Reference  | Additional Requirements   |
|--|--|---|
| Operating temperature range            | -40°C ~ +125°C (Including self-temperature rise) |   |
| Storage temperature and humidity range | -10°C to +40°C , 70% RH Max                      |   |
| High Temperature Exposure (Storage)    | MIL-STD-202 Method 108                           | 85±2°C, 168+24hours   |
| Temperature Cycling                    | JESD22 Method JA-104                             | -40°C → +85, transforming interval:20s, 100cycles   |
| Operational Life                       | MIL-PRF-2  | 85±°C, 168+24hours<br>Apply maximum rated voltage and current according part drawing  |
| External Visual                        | MIL-STD-883 Method 2009                          | Inspect device construction, marking and workmanship. Electrical Test not required.   |
| Physical Dimension                     | JESD22 Method JB-100                             | Verify physical dimensions to the applicable device detail specification. Note: User(s) and Suppliers spec. Electrical Test not required                              |
| Vibration                              | MIL-STD-202 Method 204                           | 10~55Hz,1.5mm,<br>2 hours in each 3mutually perpendicular directions (total of 6 hours)   |
| Resistance to Soldering Heat           | MIL-STD-202 Method 210                           | 1. Max. 260±5°C,10±1s, 2 times<br>2.Solder Composition: Sn/3Ag/0.5Cu  |
| Solderability                          | J-STD-002  | 245±5°C, 5±1sec, Solder: Sn/3.0Ag/0.5Cu   |
| Electrical Characterization            | Print Spec                                       | Parametrically test per lot and sample size requirements, summary to show Min, Max, Mean and Standard deviation at room as well as Min and Max Operating temperatures |
| Board Flex                             | AEC-Q200-005                                     | 2mm,30±1s   |
| Terminal Strength(SMD)                 | AEC-Q200-006                                     | 10N, 5S, X,Y direct   |



**PACKAGING**

**Reel Dimension**

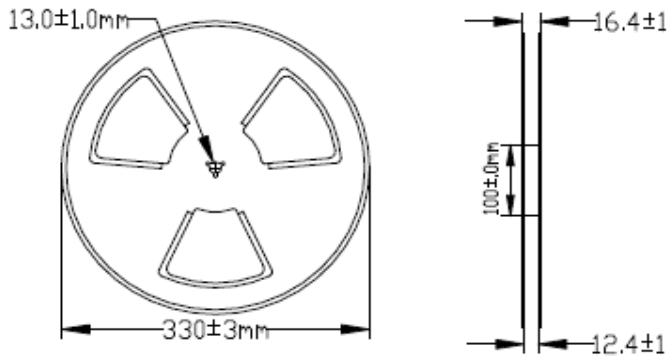

**Tape Dimension**

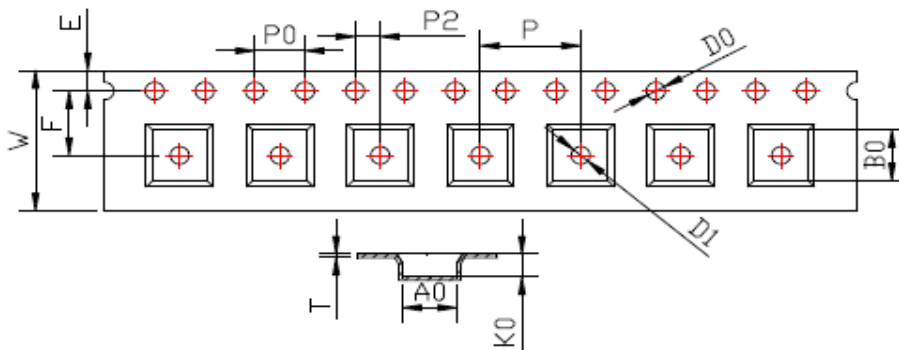

| ITEM | W              | A0   | B0   | K0   | P    | F    | E    | D0   | D1   | P0   | P2   | T     |
|------|----------------|------|------|------|------|------|------|------|------|------|------|-------|
| DIM  | 12.00          | 4.3  | 4.3  | 2.25 | 8.00 | 5.50 | 1.75 | 1.50 | 1.50 | 4.00 | 2.00 | 0.30  |
| TOLE | +0.30<br>-0.10 | ±0.1 | ±0.1 | ±0.1 | ±0.1 | ±0.1 | ±0.1 | +0.1 | +0.1 | ±0.1 | ±0.1 | ±0.05 |

**Packaging Quantity**

| P/N            | Chip/Reel | Inner Box | Outer Box |
|----------------|-----------|-----------|-----------|
| TYA4020 series | 3000pcs   | 6000pcs   | 12000pcs  |
| Size           | -         | -         | -         |

**Peeling Off Force**

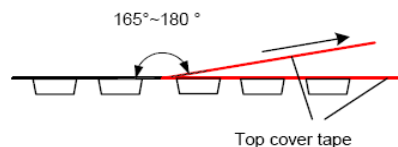

| The force peeling off cover tape is 10 to 100 grams   |                   |                 |                        |
|---|-------------------|-----------------|------------------------|
| in the arrow direction under the following conditions |                   |                 |                        |
| Room Temp   | Room Humidity (%) | Room atrn (hPa) | Teaming Speed (mm/min) |
| 5~35  | 45~85             | 860~1060        | 300                    |

**※Storage Conditions**

1. Temperature and humidity conditions: -10~+40°C and 70% RH.
2. Recommended products should be used within 12 months from the time of manufacturing.
3. The packaging material should be kept where no chlorine or sulfur exists in the air.
4. Allowable stacking condition of Packaging box: max height 1.5m or 5 boxes stacking