

## 48 x 48 Max. Counting Speed 5 KHZ Green backlit LCD display Part number 87629113



- Counter, Preselection chronometer
- Maximum input frequency 5 k Hz
- Simple parameter setting, configuration using text menus
- Easy modification of presets
- Multiplication factor
- 3 A changeover relay
- Backlit LCD display (green) : 6 digits, height 9 mm
- IP 65 sealed panel
- Option of locking the keypad, completely or partially (preset, programming)
- Accessories for 72 x 72 or 55 x 55 cut-out, DIN rail adaptor

### Part numbers

Type	Functions	Preset	Voltages	Output
87629113 Green backlit LCD display	Counter, Preselection chronometer	1	115 VAC	1 relay

### Specifications

#### Physical details and protection

Supply	11 →30 VDC / 115 V AC / 230 VAC
Relative humidity (no condensation)	EN 60068-2-30 40/93 % RLF
Altitude	0 < 2000 m
Certifications	CE
Vibration resistance in 3 axes	10-55 Hz/1 min/XYZ EN 60068-2-6 : 30 min. in each direction
Connection by screw terminals	Débrochable
Protection	Conforming to standard EN 60529 IP65 for panel/IP20 for connections
Front panel watertight seal	▪
Temperature limits use (°C)	-10 →+50
Temperature limits stored (°C)	-25 →+75
Weight (g)	150 DC version 250 AC version

#### General characteristics

Reset to zero or to preset	On panel : if not locked during programming Electrical : automatic, voltage or solid state (NPN or PNP depending on programming)
Minimum pulse time	Impulse counter : < 15 ms Chronometer : 500 µs
Option to protect against reset from front panel	▪
Scale factor (each input pulse is multiplied by this figure)	00,0001 →99,9999
Decimal point selectable for ease of reading	0 0,0 0,00 0,000 0,0000 0,00000
Sensor supply version AC	-40/+15 % 50 mA 230 VAC -40/+15 % 40 mA 115 VAC
Programming and current value backed up via EEPROM memory	▪ Service life 10 years

#### Operating characteristics

Functions	Preselection counter, Chronometer
Number of presets	1 or 2
Display	LCD with green backlighting
Height digits (mm)	LCD 9
Display details	- 999 999 →999 999

#### Inputs specifications

Inputs	2 counter inputs 1 reset input, 1 locking input
Input modes	Dir : Directional AS : up/dn PP : phase
Input type	Voltage or solid state
High level	3,5 →30 VDC
Low level	0 →2 VDC

#### Relay output characteristics

Changeover relay	▪
NO contact	Depending on version
Maximum current	3 A
Minimum current	30 mA

Maximum voltage	30 VDC / 250 VAC
Min. voltage	5 VAC/DC
Response time	< 10 ms
Mechanical life (operations)	20 x 10 <sup>6</sup>
Number of operations	1 x 10 <sup>5</sup>
Output modes : maintained or pulsed	0.01 → 99.99 s

### Accessories

Description	Code
Adaptor for 72 x 72 mm cut-out	26546842
Adaptor for 55 x 55 mm cut-out	26546846
DIN rail adaptor	26546841

### Dimensions (mm)

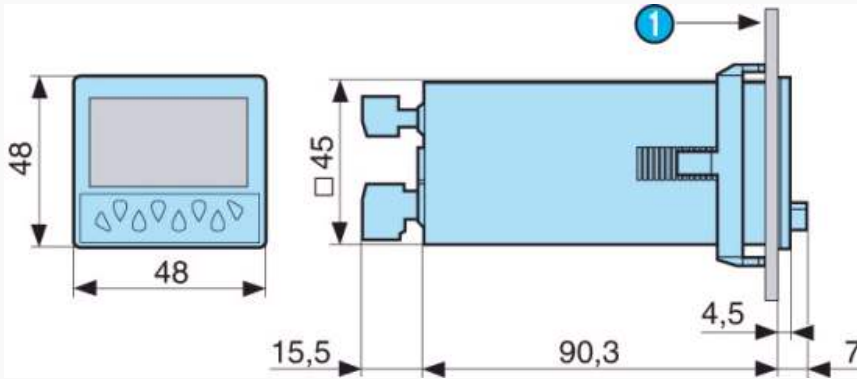

N°	Legend
1	10.5 max

### Dimensions (mm)

#### Panel cut-out

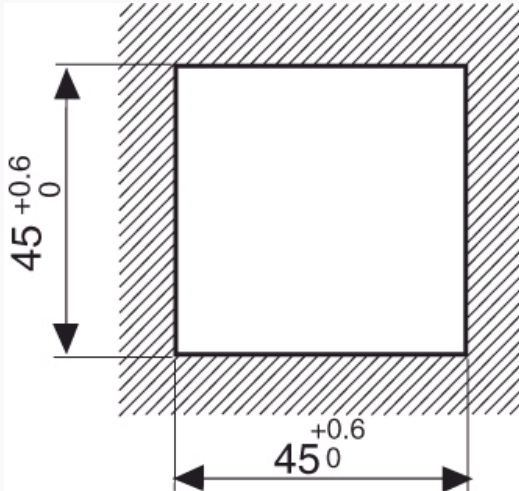

### Dimensions (mm)

#### 26546842 - Adaptor for 72 x 72 mm cut-out

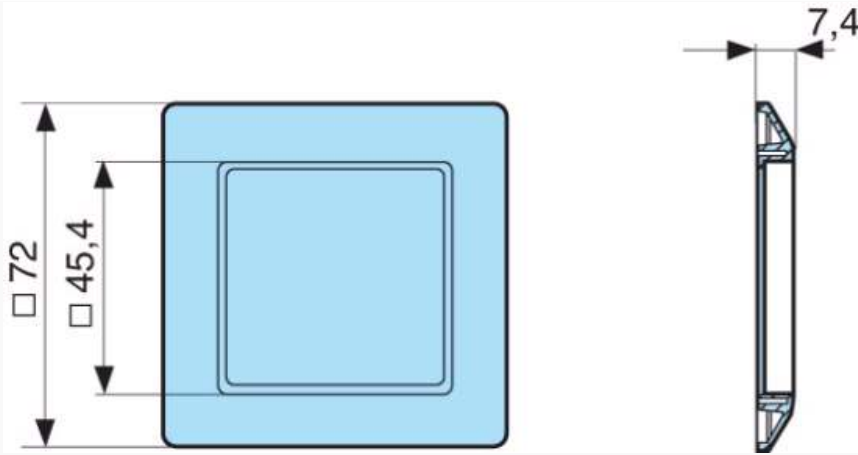

**Dimensions (mm)**

26546846 - Adaptor for 55 x 55 mm cut-out

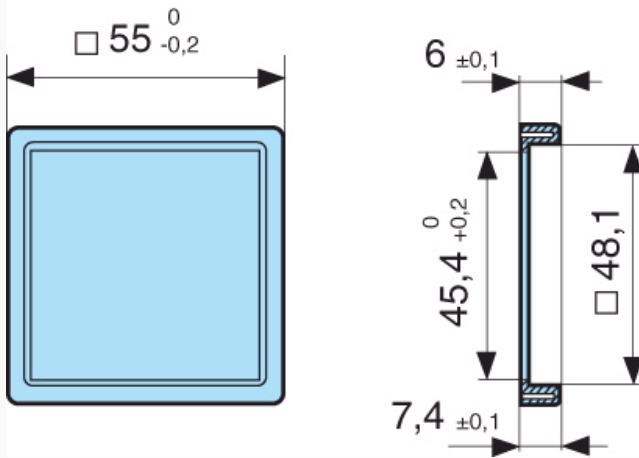

**Dimensions (mm)**

26546841 - DIN rail adaptor

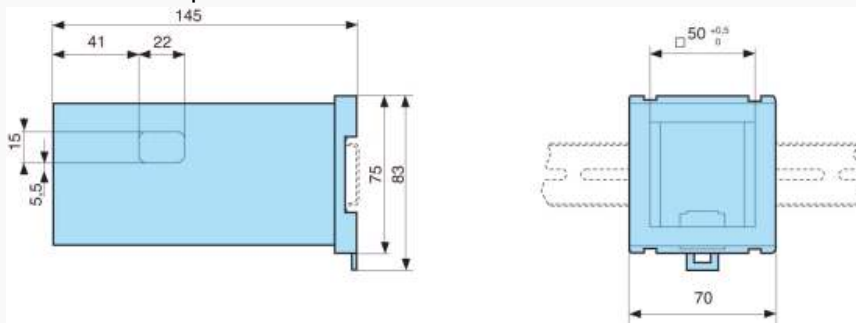

**Curves**

Counter : dir

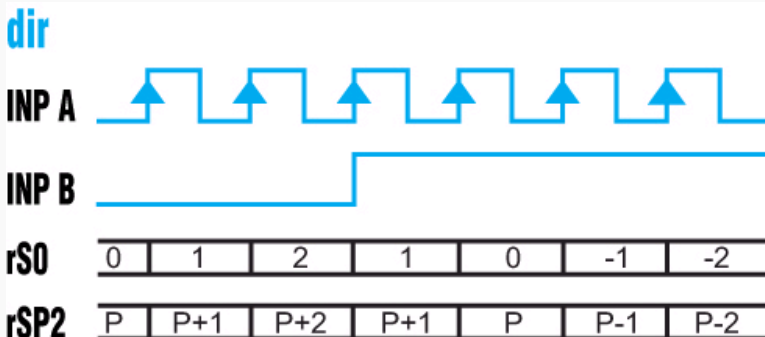

Inp A : counter input Inp B : count direction rS0 : Display 0 →Preset rSP2 : Display Preset →0

Curves

Counter : AS

AS

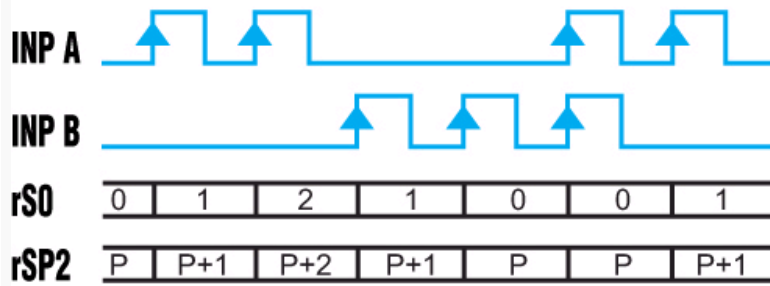

Inp A : Add. counter input 1 Inp B : Sub. counter input 2 rS0 : Display 0 →Preset rSP2 : Display Preset →0

Curves

Counter : PP

PP

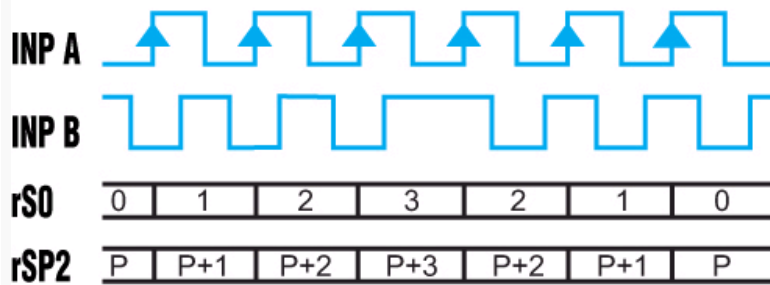

A 90° B Inp A : counter input counting on an edge Inp B : reversal of direction rS0 : Display 0 →Preset rSP2 : Display Preset →0

Curves

Chronometer : Start tcCAb

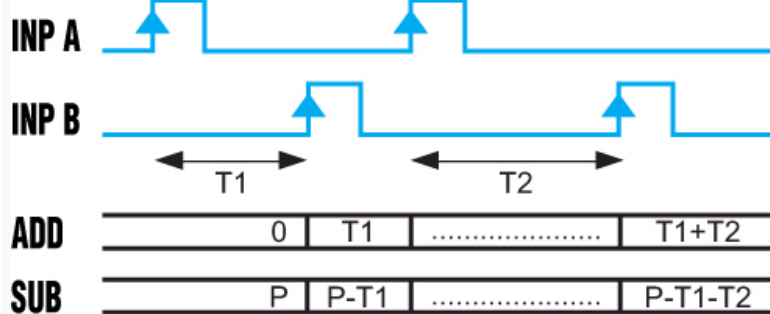

Inp A : On Inp B : Off Add : Display 0 →Preset Sub : Display Preset →0

Curves

Chronometer : Start tcCbb

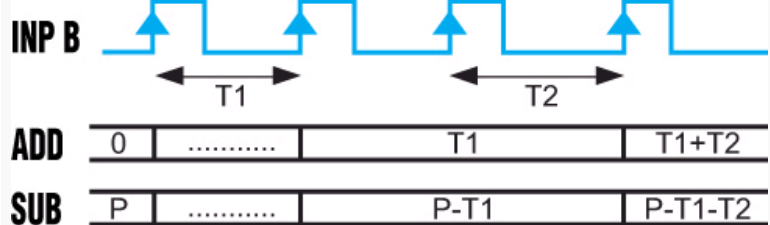

Inp A : No function Inp B : On/Off RS0/RSP2 Add : Display 0 →Preset Sub : Display Preset →0

Curves

Chronometer : Start FrErUn

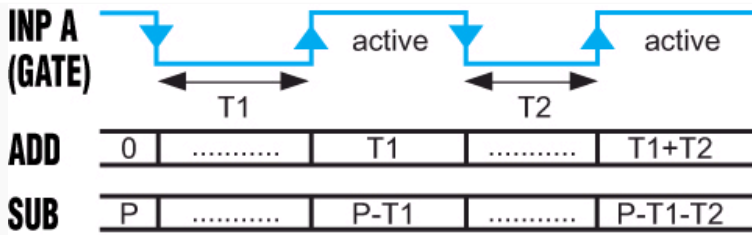

InpA : Gate Time measurement via InpA InpB : No function

**Curves**

Output operation 1 : rS0

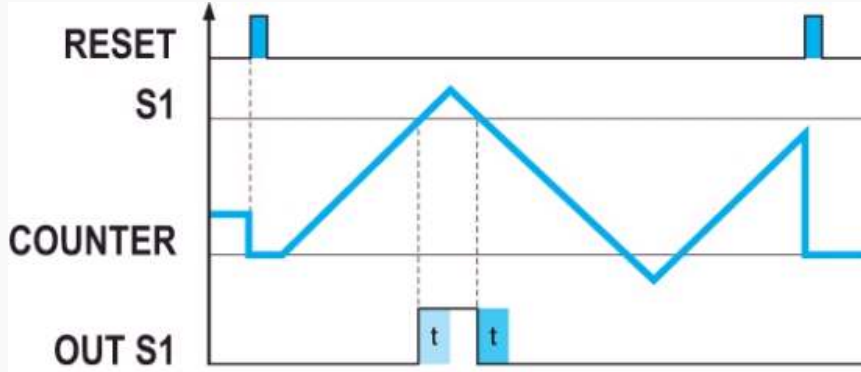

InpA : Gate Time measurement via InpA InpB : No function

**Curves**

Output operation 1 : rSA0

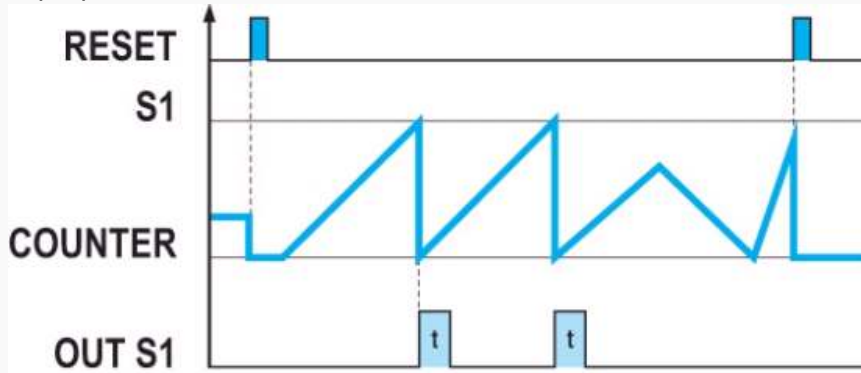

InpA : Gate Time measurement via InpA InpB : No function

**Curves**

Output operation 1 : rSP2

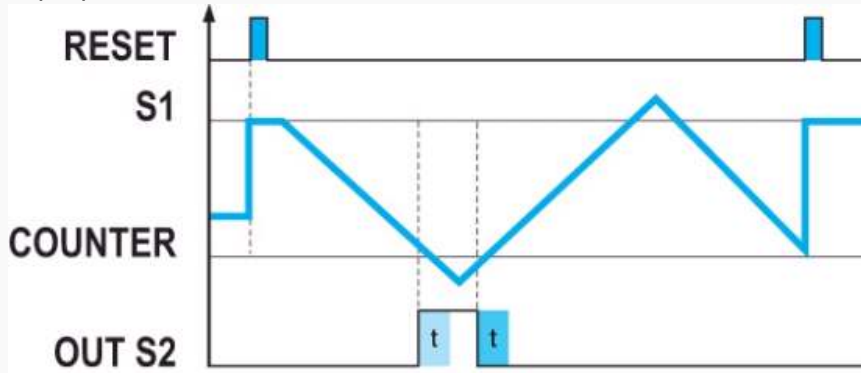

InpA : Gate Time measurement via InpA InpB : No function

**Curves**

Output operation 1 : rSAP2

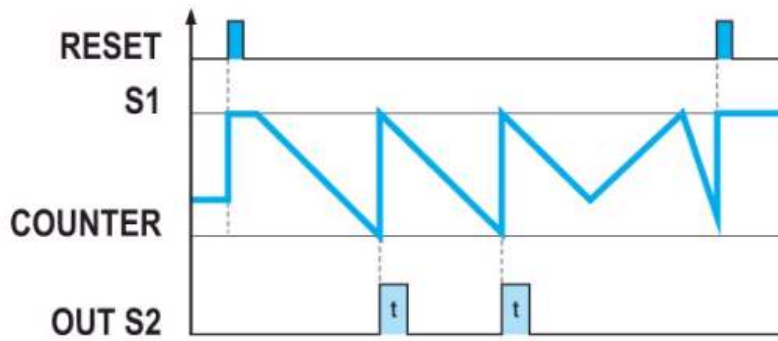

InpA : Gate Time measurement via InpA InpB : No function

Curves

Output operation 2 : rS0

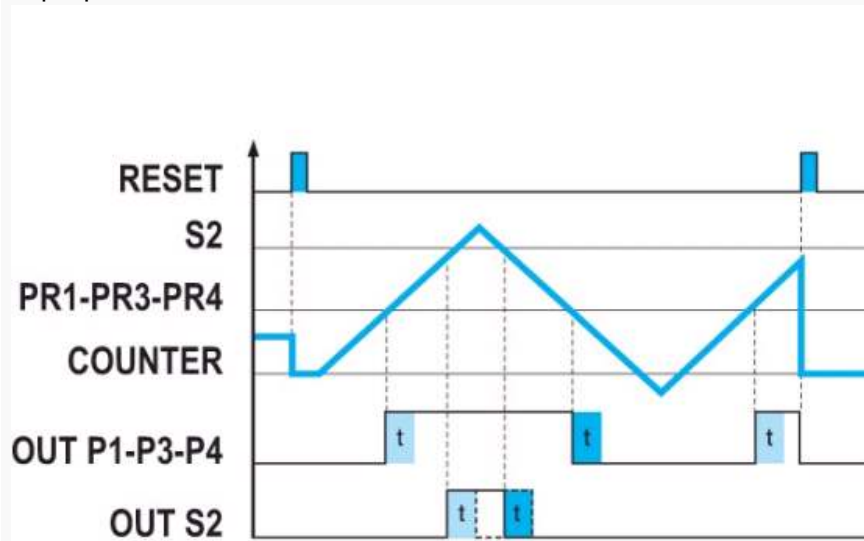

InpA : Gate Time measurement via InpA InpB : No function

Curves

Output operation 2 : rSA0

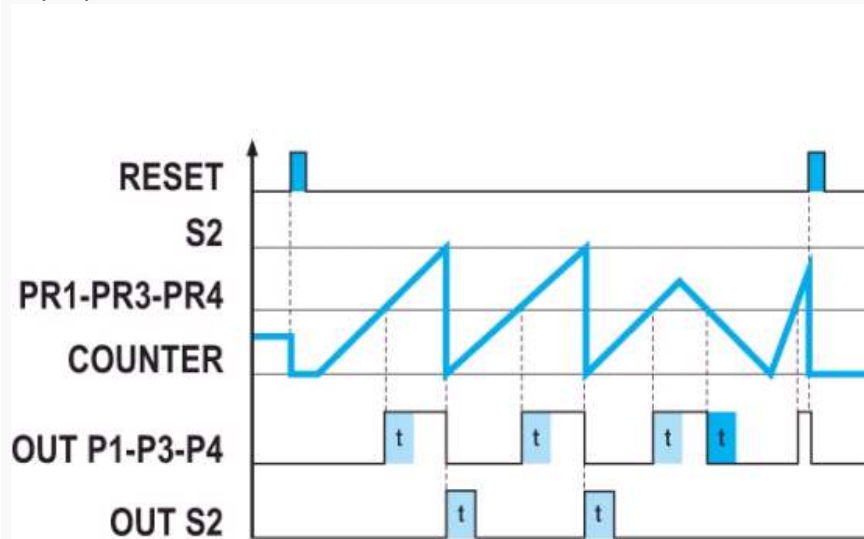

InpA : Gate Time measurement via InpA InpB : No function

Curves

Output operation 2 : rSP2

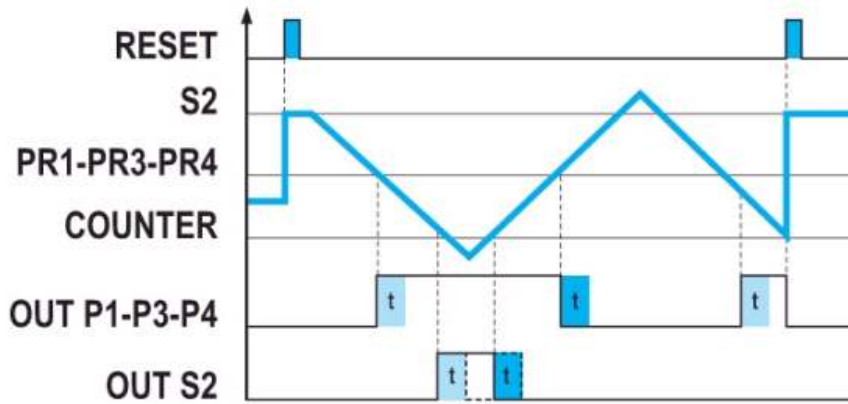

InpA : Gate Time measurement via InpA InpB : No function

Curves

Output operation 2 : rSAP2

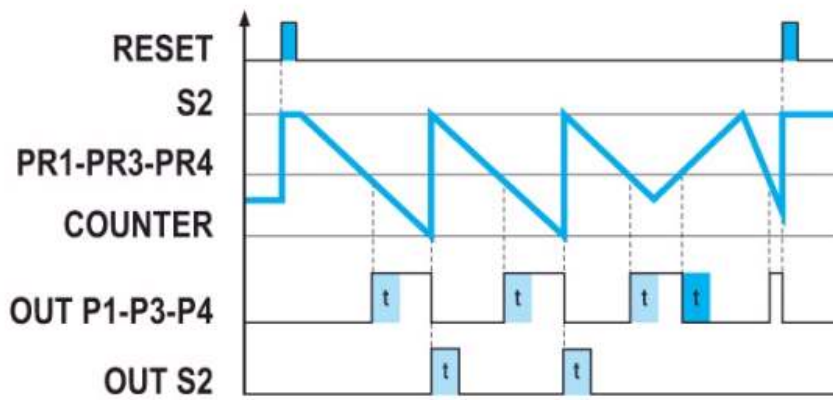

InpA : Gate Time measurement via InpA InpB : No function

Connections

87629111

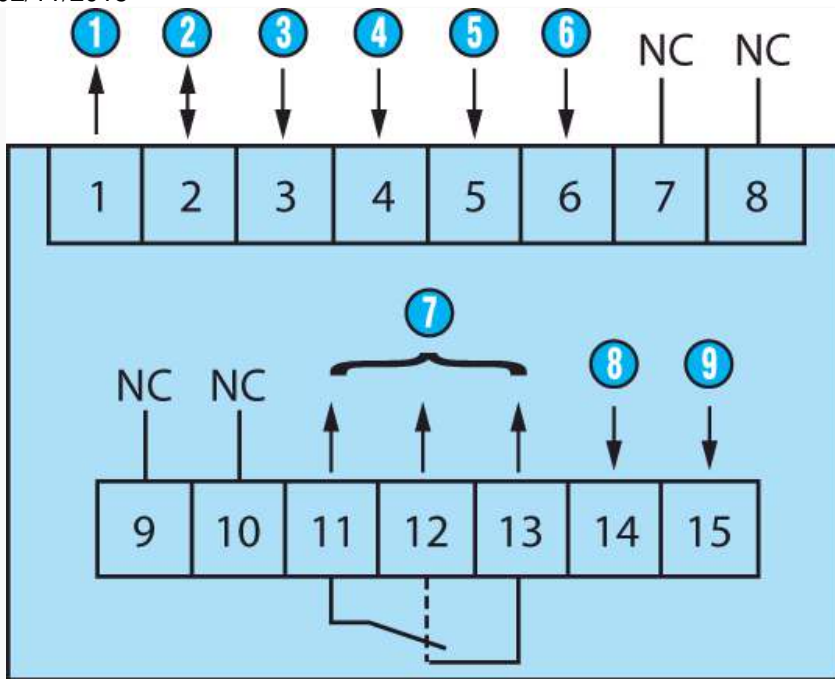

N°	Legend
1	Sensor voltage supply (* UB interconnected)
2	GND (0 VDC)
3	INP A (signal A input)
4	INP B (signal B input)
5	Reset (Reset input)
6	Lock (locking switch input)
7	11-12-13 : Output 1
8	14-15 : Supply
9	Power supply - GND

**Connections**

87629113 / 114

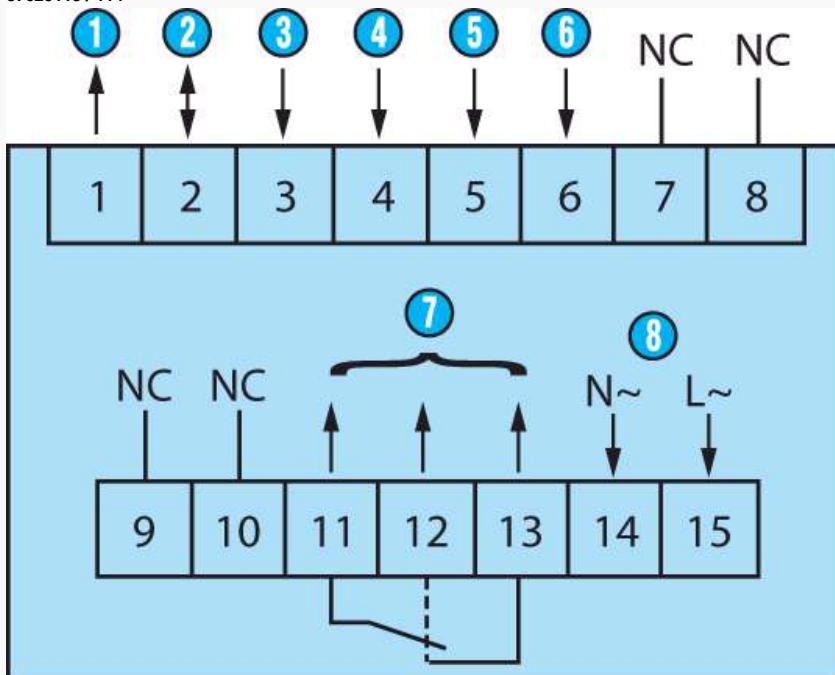



N°	Legend
①	Sensor voltage supply
②	GND (0 VDC)
③	INP A (signal A input)
④	INP B (signal B input)
⑤	Reset (Reset input)
⑥	Lock (locking switch input)
⑦	11-12-13 : Output 1
⑧	14-15 : Supply

## Connections

87629121

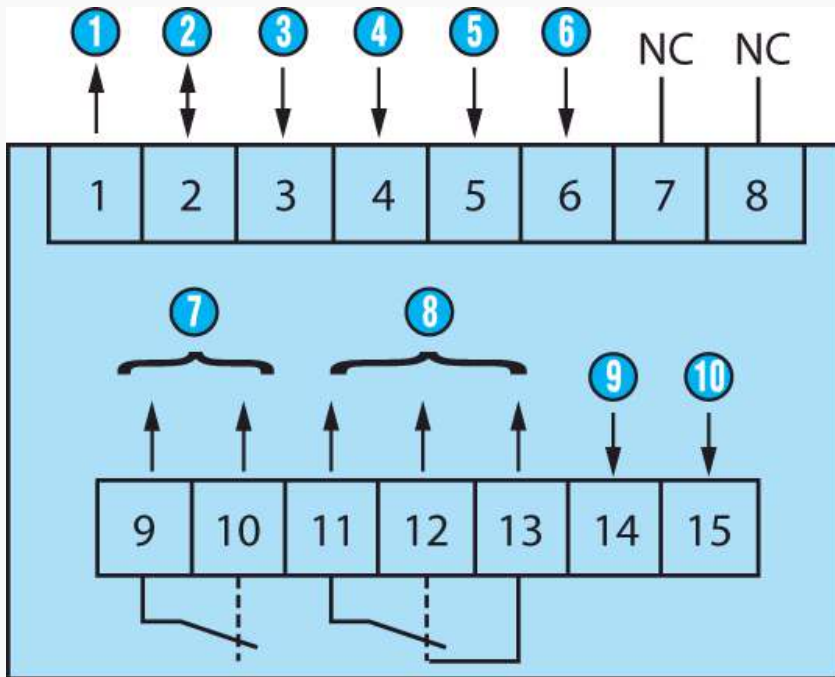

N°	Legend
①	Sensor voltage supply (* UB interconnected)
②	GND (0 VDC)
③	INP A (signal A input)
④	INP B (signal B input)
⑤	Reset (Reset input)
⑥	Lock (locking switch input)
⑦	9-10 : Output 1
⑧	11-12-13 : Output 2
⑨	14-15 : Supply
⑩	Power supply - GND

## Connections

87629123 / 124

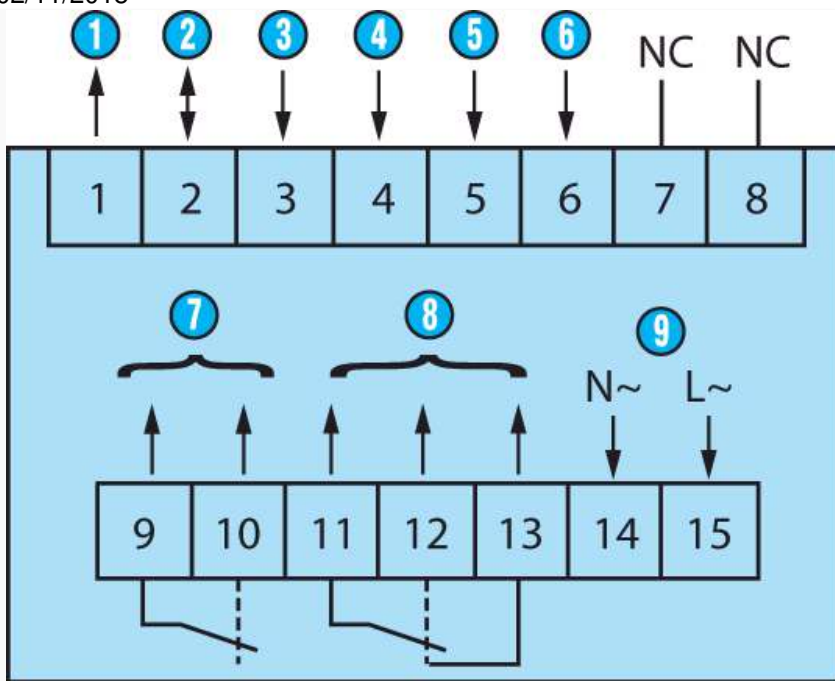

N°	Legend
①	Sensor voltage supply
②	GND (0 VDC)
③	INP A (signal A input)
④	INP B (signal B input)
⑤	Reset (Reset input)
⑥	Lock (locking switch input)
⑦	9-10 : Output 1
⑧	11-12-13 : Output 2
⑨	14-15 : Supply

### Applications

#### Programming diagram

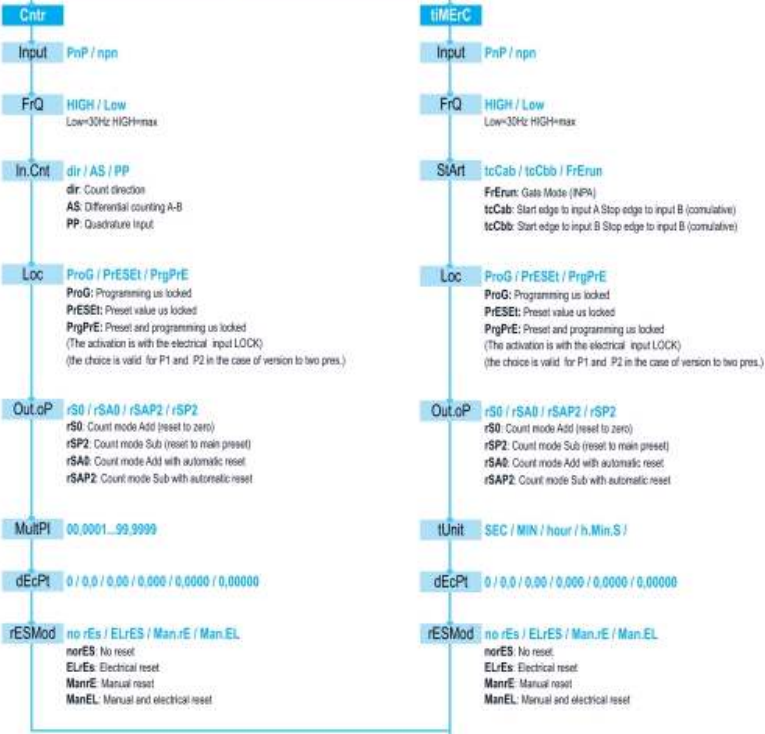

	Low : 1.0 V High : 4.0 V		Low : 3.0 V High : 30.0 V	
	rS0 rSP2	rSA0 rSAP2	rS0 rSP2	rSA0 rSAP2
dir	15 kHz	1.5 kHz	5 kHz	1.2 kHz
AS	10 kHz	1.5 kHz	5 kHz	1.2 kHz
PP	10 kHz	0.7 kHz	2.4 kHz	0.5 kHz

