

SmartPIM1 Modul mit Trench/Feldstopp IGBT4 und Emitter Controlled 4 Diode und PressFIT / NTC  
SmartPIM1 module with Trench/Fieldstop IGBT4 and Emitter Controlled 4 diode and PressFIT / NTC

**Vorläufige Daten / Preliminary Data**

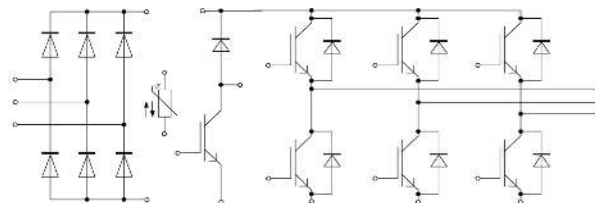

$V_{CES} = 1200V$   
 $I_{C\ nom} = 25A / I_{CRM} = 50A$

**Typische Anwendungen**

- Hilfsumrichter
- Klimaanlage
- Motorantriebe
- Servoumrichter

**Typical Applications**

- Auxiliary Inverters
- Air Conditioning
- Motor Drives
- Servo Drives

**Elektrische Eigenschaften**

- Niedrige Schaltverluste
- Trench IGBT 4
- $T_{vj\ op} = 150^{\circ}C$
- Niedriges  $V_{CEsat}$

**Electrical Features**

- Low Switching Losses
- Trench IGBT 4
- $T_{vj\ op} = 150^{\circ}C$
- Low  $V_{CEsat}$

**Mechanische Eigenschaften**

- $Al_2O_3$  Substrat mit kleinem thermischen Widerstand
- Robuste Duplex-Rahmen Konstruktion
- Robuste selbsteinpressende Montage

**Mechanical Features**

- $Al_2O_3$  Substrate with Low Thermal Resistance
- Rugged Duplex frame construction
- Rugged selfacting PressFIT assembly

**Module Label Code**

Barcode Code 128



DMX - Code



**Content of the Code**

Content of the Code	Digit
Module Serial Number	1 - 5
Module Material Number	6 - 11
Production Order Number	12 - 19
Datecode (Production Year)	20 - 21
Datecode (Production Week)	22 - 23

prepared by: DK	date of publication: 2013-11-05	
approved by: MB	revision: 2.0	UL approved (E83335)

**Vorläufige Daten  
Preliminary Data**

**IGBT, Wechselrichter / IGBT, Inverter  
Höchstzulässige Werte / Maximum Rated Values**

Kollektor-Emitter-Sperrspannung Collector-emitter voltage	$T_{vj} = 25^{\circ}\text{C}$	$V_{CES}$	1200	V
Kollektor-Dauergleichstrom Continuous DC collector current	$T_C = 100^{\circ}\text{C}, T_{vj\text{max}} = 175^{\circ}\text{C}$ $T_C = 25^{\circ}\text{C}, T_{vj\text{max}} = 175^{\circ}\text{C}$	$I_{C\text{nom}}$ $I_C$	25 39	A A
Periodischer Kollektor-Spitzenstrom Repetitive peak collector current	$t_P = 1\text{ ms}$	$I_{CRM}$	50	A
Gesamt-Verlustleistung Total power dissipation	$T_C = 25^{\circ}\text{C}, T_{vj\text{max}} = 175^{\circ}\text{C}$	$P_{tot}$	190	W
Gate-Emitter-Spitzenspannung Gate-emitter peak voltage		$V_{GES}$	+/-20	V

**Charakteristische Werte / Characteristic Values**

			min.	typ.	max.	
Kollektor-Emitter-Sättigungsspannung Collector-emitter saturation voltage	$I_C = 25\text{ A}, V_{GE} = 15\text{ V}$ $I_C = 25\text{ A}, V_{GE} = 15\text{ V}$ $I_C = 25\text{ A}, V_{GE} = 15\text{ V}$	$T_{vj} = 25^{\circ}\text{C}$ $T_{vj} = 125^{\circ}\text{C}$ $T_{vj} = 150^{\circ}\text{C}$	$V_{CE\text{sat}}$	1,85 2,15 2,25	2,25	V V V
Gate-Schwellenspannung Gate threshold voltage	$I_C = 0,80\text{ mA}, V_{CE} = V_{GE}, T_{vj} = 25^{\circ}\text{C}$		$V_{GEth}$	5,2 5,8	6,4	V
Gateladung Gate charge	$V_{GE} = -15\text{ V} \dots +15\text{ V}$		$Q_G$	0,20		$\mu\text{C}$
Interner Gatewiderstand Internal gate resistor	$T_{vj} = 25^{\circ}\text{C}$		$R_{Gint}$	0,0		$\Omega$
Eingangskapazität Input capacitance	$f = 1\text{ MHz}, T_{vj} = 25^{\circ}\text{C}, V_{CE} = 25\text{ V}, V_{GE} = 0\text{ V}$		$C_{ies}$	1,45		nF
Rückwirkungskapazität Reverse transfer capacitance	$f = 1\text{ MHz}, T_{vj} = 25^{\circ}\text{C}, V_{CE} = 25\text{ V}, V_{GE} = 0\text{ V}$		$C_{res}$	0,05		nF
Kollektor-Emitter-Reststrom Collector-emitter cut-off current	$V_{CE} = 1200\text{ V}, V_{GE} = 0\text{ V}, T_{vj} = 25^{\circ}\text{C}$		$I_{CES}$		1,0	mA
Gate-Emitter-Reststrom Gate-emitter leakage current	$V_{CE} = 0\text{ V}, V_{GE} = 20\text{ V}, T_{vj} = 25^{\circ}\text{C}$		$I_{GES}$		400	nA
Einschaltverzögerungszeit, induktive Last Turn-on delay time, inductive load	$I_C = 25\text{ A}, V_{CE} = 600\text{ V}$ $V_{GE} = \pm 15\text{ V}$ $R_{Gon} = 20\ \Omega$	$T_{vj} = 25^{\circ}\text{C}$ $T_{vj} = 125^{\circ}\text{C}$ $T_{vj} = 150^{\circ}\text{C}$	$t_{don}$	0,026 0,026 0,026		$\mu\text{s}$ $\mu\text{s}$ $\mu\text{s}$
Anstiegszeit, induktive Last Rise time, inductive load	$I_C = 25\text{ A}, V_{CE} = 600\text{ V}$ $V_{GE} = \pm 15\text{ V}$ $R_{Gon} = 20\ \Omega$	$T_{vj} = 25^{\circ}\text{C}$ $T_{vj} = 125^{\circ}\text{C}$ $T_{vj} = 150^{\circ}\text{C}$	$t_r$	0,016 0,02 0,021		$\mu\text{s}$ $\mu\text{s}$ $\mu\text{s}$
Abschaltverzögerungszeit, induktive Last Turn-off delay time, inductive load	$I_C = 25\text{ A}, V_{CE} = 600\text{ V}$ $V_{GE} = \pm 15\text{ V}$ $R_{Goff} = 20\ \Omega$	$T_{vj} = 25^{\circ}\text{C}$ $T_{vj} = 125^{\circ}\text{C}$ $T_{vj} = 150^{\circ}\text{C}$	$t_{doff}$	0,19 0,28 0,30		$\mu\text{s}$ $\mu\text{s}$ $\mu\text{s}$
Fallzeit, induktive Last Fall time, inductive load	$I_C = 25\text{ A}, V_{CE} = 600\text{ V}$ $V_{GE} = \pm 15\text{ V}$ $R_{Goff} = 20\ \Omega$	$T_{vj} = 25^{\circ}\text{C}$ $T_{vj} = 125^{\circ}\text{C}$ $T_{vj} = 150^{\circ}\text{C}$	$t_f$	0,18 0,21 0,22		$\mu\text{s}$ $\mu\text{s}$ $\mu\text{s}$
Einschaltverlustenergie pro Puls Turn-on energy loss per pulse	$I_C = 25\text{ A}, V_{CE} = 600\text{ V}, L_S = 35\text{ nH}$ $V_{GE} = \pm 15\text{ V}, di/dt = 1700\text{ A}/\mu\text{s} (T_{vj} = 150^{\circ}\text{C})$ $R_{Gon} = 20\ \Omega$	$T_{vj} = 25^{\circ}\text{C}$ $T_{vj} = 125^{\circ}\text{C}$ $T_{vj} = 150^{\circ}\text{C}$	$E_{on}$	1,60 2,40 2,60		mJ mJ mJ
Abschaltverlustenergie pro Puls Turn-off energy loss per pulse	$I_C = 25\text{ A}, V_{CE} = 600\text{ V}, L_S = 35\text{ nH}$ $V_{GE} = \pm 15\text{ V}, du/dt = 3600\text{ V}/\mu\text{s} (T_{vj} = 150^{\circ}\text{C})$ $R_{Goff} = 20\ \Omega$	$T_{vj} = 25^{\circ}\text{C}$ $T_{vj} = 125^{\circ}\text{C}$ $T_{vj} = 150^{\circ}\text{C}$	$E_{off}$	1,45 2,15 2,35		mJ mJ mJ
Kurzschlussverhalten SC data	$V_{GE} \leq 15\text{ V}, V_{CC} = 800\text{ V}$ $V_{CEmax} = V_{CES} - L_{SCE} \cdot di/dt$ $t_P \leq 10\ \mu\text{s}, T_{vj} = 150^{\circ}\text{C}$		$I_{SC}$	90		A
Wärmewiderstand, Chip bis Gehäuse Thermal resistance, junction to case	pro IGBT / per IGBT		$R_{thJC}$	0,70	0,80	K/W
Wärmewiderstand, Gehäuse bis Kühlkörper Thermal resistance, case to heatsink	pro IGBT / per IGBT $\lambda_{Paste} = 1\text{ W}/(\text{m}\cdot\text{K})$ / $\lambda_{grease} = 1\text{ W}/(\text{m}\cdot\text{K})$		$R_{thCH}$	0,60		K/W
Temperatur im Schaltbetrieb Temperature under switching conditions			$T_{vj\text{op}}$	-40	150	$^{\circ}\text{C}$

prepared by: DK	date of publication: 2013-11-05
approved by: MB	revision: 2.0



**Vorläufige Daten  
Preliminary Data**

**Diode, Wechselrichter / Diode, Inverter**

**Höchstzulässige Werte / Maximum Rated Values**

Periodische Spitzensperrspannung Repetitive peak reverse voltage	$T_{vj} = 25^{\circ}\text{C}$	$V_{RRM}$	1200	V
Dauergleichstrom Continuous DC forward current		$I_F$	25	A
Periodischer Spitzenstrom Repetitive peak forward current	$t_P = 1\text{ ms}$	$I_{FRM}$	50	A
Grenzlastintegral $I^2t$ - value	$V_R = 0\text{ V}, t_P = 10\text{ ms}, T_{vj} = 125^{\circ}\text{C}$ $V_R = 0\text{ V}, t_P = 10\text{ ms}, T_{vj} = 150^{\circ}\text{C}$	$I^2t$	90,0 75,0	$\text{A}^2\text{s}$ $\text{A}^2\text{s}$

**Charakteristische Werte / Characteristic Values**

			min.	typ.	max.	
Durchlassspannung Forward voltage	$I_F = 25\text{ A}, V_{GE} = 0\text{ V}$ $I_F = 25\text{ A}, V_{GE} = 0\text{ V}$ $I_F = 25\text{ A}, V_{GE} = 0\text{ V}$	$T_{vj} = 25^{\circ}\text{C}$ $T_{vj} = 125^{\circ}\text{C}$ $T_{vj} = 150^{\circ}\text{C}$	$V_F$	1,75 1,75 1,75	2,25	V V V
Rückstromspitze Peak reverse recovery current	$I_F = 25\text{ A}, -di_F/dt = 1700\text{ A}/\mu\text{s} (T_{vj}=150^{\circ}\text{C})$ $V_R = 600\text{ V}$ $V_{GE} = -15\text{ V}$	$T_{vj} = 25^{\circ}\text{C}$ $T_{vj} = 125^{\circ}\text{C}$ $T_{vj} = 150^{\circ}\text{C}$	$I_{RM}$	48,0 50,0 52,0		A A A
Sperrverzögerungsladung Recovered charge	$I_F = 25\text{ A}, -di_F/dt = 1700\text{ A}/\mu\text{s} (T_{vj}=150^{\circ}\text{C})$ $V_R = 600\text{ V}$ $V_{GE} = -15\text{ V}$	$T_{vj} = 25^{\circ}\text{C}$ $T_{vj} = 125^{\circ}\text{C}$ $T_{vj} = 150^{\circ}\text{C}$	$Q_r$	2,50 4,40 4,90		$\mu\text{C}$ $\mu\text{C}$ $\mu\text{C}$
Abschaltenergie pro Puls Reverse recovery energy	$I_F = 25\text{ A}, -di_F/dt = 1700\text{ A}/\mu\text{s} (T_{vj}=150^{\circ}\text{C})$ $V_R = 600\text{ V}$ $V_{GE} = -15\text{ V}$	$T_{vj} = 25^{\circ}\text{C}$ $T_{vj} = 125^{\circ}\text{C}$ $T_{vj} = 150^{\circ}\text{C}$	$E_{rec}$	0,95 1,75 2,05		mJ mJ mJ
Wärmewiderstand, Chip bis Gehäuse Thermal resistance, junction to case	pro Diode / per diode		$R_{thJC}$	1,00	1,10	K/W
Wärmewiderstand, Gehäuse bis Kühlkörper Thermal resistance, case to heatsink	pro Diode / per diode $\lambda_{Paste} = 1\text{ W}/(\text{m}\cdot\text{K})$ / $\lambda_{grease} = 1\text{ W}/(\text{m}\cdot\text{K})$		$R_{thCH}$	0,80		K/W
Temperatur im Schaltbetrieb Temperature under switching conditions			$T_{vj\text{ op}}$	-40	150	$^{\circ}\text{C}$

**Diode, Gleichrichter / Diode, Rectifier**

**Höchstzulässige Werte / Maximum Rated Values**

Periodische Spitzensperrspannung Repetitive peak reverse voltage	$T_{vj} = 25^{\circ}\text{C}$	$V_{RRM}$	1600	V
Durchlassstrom Grenzeffektivwert pro Chip Maximum RMS forward current per chip	$T_C = 100^{\circ}\text{C}$	$I_{FRMSM}$	50	A
Gleichrichter Ausgang Grenzeffektivstrom Maximum RMS current at rectifier output	$T_C = 100^{\circ}\text{C}$	$I_{RMSM}$	50	A
Stoßstrom Grenzwert Surge forward current	$t_p = 10\text{ ms}, T_{vj} = 25^{\circ}\text{C}$ $t_p = 10\text{ ms}, T_{vj} = 150^{\circ}\text{C}$	$I_{FSM}$	450 370	A A
Grenzlastintegral $I^2t$ - value	$t_p = 10\text{ ms}, T_{vj} = 25^{\circ}\text{C}$ $t_p = 10\text{ ms}, T_{vj} = 150^{\circ}\text{C}$	$I^2t$	1000 685	$\text{A}^2\text{s}$ $\text{A}^2\text{s}$

**Charakteristische Werte / Characteristic Values**

			min.	typ.	max.	
Durchlassspannung Forward voltage	$T_{vj} = 150^{\circ}\text{C}, I_F = 25\text{ A}$	$V_F$		0,90		V
Sperrstrom Reverse current	$T_{vj} = 150^{\circ}\text{C}, V_R = 1600\text{ V}$	$I_R$		1,00		mA
Wärmewiderstand, Chip bis Gehäuse Thermal resistance, junction to case	pro Diode / per diode		$R_{thJC}$	0,95	1,05	K/W
Wärmewiderstand, Gehäuse bis Kühlkörper Thermal resistance, case to heatsink	pro Diode / per diode $\lambda_{Paste} = 1\text{ W}/(\text{m}\cdot\text{K})$ / $\lambda_{grease} = 1\text{ W}/(\text{m}\cdot\text{K})$		$R_{thCH}$	0,85		K/W
Temperatur im Schaltbetrieb Temperature under switching conditions			$T_{vj\text{ op}}$			$^{\circ}\text{C}$

prepared by: DK	date of publication: 2013-11-05
approved by: MB	revision: 2.0

**Vorläufige Daten  
Preliminary Data**

**IGBT, Brems-Chopper / IGBT, Brake-Chopper  
Höchstzulässige Werte / Maximum Rated Values**

Kollektor-Emitter-Sperrspannung Collector-emitter voltage	$T_{vj} = 25^{\circ}\text{C}$	$V_{CES}$	1200	V
Kollektor-Dauergleichstrom Continuous DC collector current	$T_C = 100^{\circ}\text{C}, T_{vj\max} = 175^{\circ}\text{C}$ $T_C = 25^{\circ}\text{C}, T_{vj\max} = 175^{\circ}\text{C}$	$I_{C\text{nom}}$ $I_C$	25 39	A A
Periodischer Kollektor-Spitzenstrom Repetitive peak collector current	$t_P = 1\text{ ms}$	$I_{CRM}$	50	A
Gesamt-Verlustleistung Total power dissipation	$T_C = 25^{\circ}\text{C}, T_{vj\max} = 175^{\circ}\text{C}$	$P_{\text{tot}}$	190	W
Gate-Emitter-Spitzenspannung Gate-emitter peak voltage		$V_{GES}$	+/-20	V

**Charakteristische Werte / Characteristic Values**

			min.	typ.	max.		
Kollektor-Emitter-Sättigungsspannung Collector-emitter saturation voltage	$I_C = 25\text{ A}, V_{GE} = 15\text{ V}$ $I_C = 25\text{ A}, V_{GE} = 15\text{ V}$ $I_C = 25\text{ A}, V_{GE} = 15\text{ V}$	$T_{vj} = 25^{\circ}\text{C}$ $T_{vj} = 125^{\circ}\text{C}$ $T_{vj} = 150^{\circ}\text{C}$	$V_{CE\text{sat}}$	1,85 2,15 2,25	2,25	V V V	
Gate-Schwellenspannung Gate threshold voltage	$I_C = 0,80\text{ mA}, V_{CE} = V_{GE}, T_{vj} = 25^{\circ}\text{C}$		$V_{GEth}$	5,2	5,8	6,4	V
Gateladung Gate charge	$V_{GE} = -15\text{ V} \dots +15\text{ V}$		$Q_G$	0,20			$\mu\text{C}$
Interner Gatewiderstand Internal gate resistor	$T_{vj} = 25^{\circ}\text{C}$		$R_{Gint}$	0,0			$\Omega$
Eingangskapazität Input capacitance	$f = 1\text{ MHz}, T_{vj} = 25^{\circ}\text{C}, V_{CE} = 25\text{ V}, V_{GE} = 0\text{ V}$		$C_{ies}$	1,45			nF
Rückwirkungskapazität Reverse transfer capacitance	$f = 1\text{ MHz}, T_{vj} = 25^{\circ}\text{C}, V_{CE} = 25\text{ V}, V_{GE} = 0\text{ V}$		$C_{res}$	0,05			nF
Kollektor-Emitter-Reststrom Collector-emitter cut-off current	$V_{CE} = 1200\text{ V}, V_{GE} = 0\text{ V}, T_{vj} = 25^{\circ}\text{C}$		$I_{CES}$			1,0	mA
Gate-Emitter-Reststrom Gate-emitter leakage current	$V_{CE} = 0\text{ V}, V_{GE} = 20\text{ V}, T_{vj} = 25^{\circ}\text{C}$		$I_{GES}$			400	nA
Einschaltverzögerungszeit, induktive Last Turn-on delay time, inductive load	$I_C = 25\text{ A}, V_{CE} = 600\text{ V}$ $V_{GE} = \pm 15\text{ V}$ $R_{Gon} = 68\ \Omega$	$T_{vj} = 25^{\circ}\text{C}$ $T_{vj} = 125^{\circ}\text{C}$ $T_{vj} = 150^{\circ}\text{C}$	$t_{don}$	0,08 0,08 0,08			$\mu\text{s}$ $\mu\text{s}$ $\mu\text{s}$
Anstiegszeit, induktive Last Rise time, inductive load	$I_C = 25\text{ A}, V_{CE} = 600\text{ V}$ $V_{GE} = \pm 15\text{ V}$ $R_{Gon} = 68\ \Omega$	$T_{vj} = 25^{\circ}\text{C}$ $T_{vj} = 125^{\circ}\text{C}$ $T_{vj} = 150^{\circ}\text{C}$	$t_r$	0,042 0,051 0,053			$\mu\text{s}$ $\mu\text{s}$ $\mu\text{s}$
Abschaltverzögerungszeit, induktive Last Turn-off delay time, inductive load	$I_C = 25\text{ A}, V_{CE} = 600\text{ V}$ $V_{GE} = \pm 15\text{ V}$ $R_{Goff} = 68\ \Omega$	$T_{vj} = 25^{\circ}\text{C}$ $T_{vj} = 125^{\circ}\text{C}$ $T_{vj} = 150^{\circ}\text{C}$	$t_{doff}$	0,34 0,44 0,46			$\mu\text{s}$ $\mu\text{s}$ $\mu\text{s}$
Fallzeit, induktive Last Fall time, inductive load	$I_C = 25\text{ A}, V_{CE} = 600\text{ V}$ $V_{GE} = \pm 15\text{ V}$ $R_{Goff} = 68\ \Omega$	$T_{vj} = 25^{\circ}\text{C}$ $T_{vj} = 125^{\circ}\text{C}$ $T_{vj} = 150^{\circ}\text{C}$	$t_f$	0,18 0,215 0,225			$\mu\text{s}$ $\mu\text{s}$ $\mu\text{s}$
Einschaltverlustenergie pro Puls Turn-on energy loss per pulse	$I_C = 25\text{ A}, V_{CE} = 600\text{ V}, L_S = 35\text{ nH}$ $V_{GE} = \pm 15\text{ V}$ $R_{Gon} = 68\ \Omega$	$T_{vj} = 25^{\circ}\text{C}$ $T_{vj} = 125^{\circ}\text{C}$ $T_{vj} = 150^{\circ}\text{C}$	$E_{on}$	3,90 5,00 5,40			mJ mJ mJ
Abschaltverlustenergie pro Puls Turn-off energy loss per pulse	$I_C = 25\text{ A}, V_{CE} = 600\text{ V}, L_S = 35\text{ nH}$ $V_{GE} = \pm 15\text{ V}$ $R_{Goff} = 68\ \Omega$	$T_{vj} = 25^{\circ}\text{C}$ $T_{vj} = 125^{\circ}\text{C}$ $T_{vj} = 150^{\circ}\text{C}$	$E_{off}$	1,50 2,20 2,40			mJ mJ mJ
Kurzschlußverhalten SC data	$V_{GE} \leq 15\text{ V}, V_{CC} = 800\text{ V}$ $V_{CEmax} = V_{CES} - L_{SCE} \cdot di/dt$ $t_P \leq 10\ \mu\text{s}, T_{vj} = 150^{\circ}\text{C}$		$I_{SC}$	90			A
Wärmewiderstand, Chip bis Gehäuse Thermal resistance, junction to case	pro IGBT / per IGBT		$R_{thJC}$	0,70	0,80		K/W
Wärmewiderstand, Gehäuse bis Kühlkörper Thermal resistance, case to heatsink	pro IGBT / per IGBT $\lambda_{\text{Paste}} = 1\text{ W}/(\text{m}\cdot\text{K})$ / $\lambda_{\text{grease}} = 1\text{ W}/(\text{m}\cdot\text{K})$		$R_{thCH}$	0,60			K/W
Temperatur im Schaltbetrieb Temperature under switching conditions			$T_{vj\text{op}}$	-40	150		$^{\circ}\text{C}$

prepared by: DK	date of publication: 2013-11-05
approved by: MB	revision: 2.0

**Vorläufige Daten  
Preliminary Data**

**Diode, Brems-Chopper / Diode, Brake-Chopper  
Höchstzulässige Werte / Maximum Rated Values**

Periodische Spitzensperrspannung Repetitive peak reverse voltage	$T_{vj} = 25^{\circ}\text{C}$	$V_{RRM}$	1200	V
Dauergleichstrom Continuous DC forward current		$I_F$	10	A
Periodischer Spitzenstrom Repetitive peak forward current	$t_P = 1\text{ ms}$	$I_{FRM}$	20	A
Grenzlastintegral $I^2t$ - value	$V_R = 0\text{ V}, t_P = 10\text{ ms}, T_{vj} = 125^{\circ}\text{C}$ $V_R = 0\text{ V}, t_P = 10\text{ ms}, T_{vj} = 150^{\circ}\text{C}$	$I^2t$	16,0 14,0	$\text{A}^2\text{s}$ $\text{A}^2\text{s}$

**Charakteristische Werte / Characteristic Values**

			min.	typ.	max.	
Durchlassspannung Forward voltage	$I_F = 10\text{ A}, V_{GE} = 0\text{ V}$	$T_{vj} = 25^{\circ}\text{C}$		1,75	2,25	V
	$I_F = 10\text{ A}, V_{GE} = 0\text{ V}$	$T_{vj} = 125^{\circ}\text{C}$		1,75		V
	$I_F = 10\text{ A}, V_{GE} = 0\text{ V}$	$T_{vj} = 150^{\circ}\text{C}$		1,75		V
Rückstromspitze Peak reverse recovery current	$I_F = 10\text{ A}, -di_F/dt = 500\text{ A}/\mu\text{s} (T_{vj}=150^{\circ}\text{C})$ $V_R = 600\text{ V}$	$T_{vj} = 25^{\circ}\text{C}$		12,0		A
		$T_{vj} = 125^{\circ}\text{C}$		10,0		A
		$T_{vj} = 150^{\circ}\text{C}$		8,00		A
Sperrverzögerungsladung Recovered charge	$I_F = 10\text{ A}, -di_F/dt = 500\text{ A}/\mu\text{s} (T_{vj}=150^{\circ}\text{C})$ $V_R = 600\text{ V}$	$T_{vj} = 25^{\circ}\text{C}$		0,90		$\mu\text{C}$
		$T_{vj} = 125^{\circ}\text{C}$		1,70		$\mu\text{C}$
		$T_{vj} = 150^{\circ}\text{C}$		1,90		$\mu\text{C}$
Abschaltenergie pro Puls Reverse recovery energy	$I_F = 10\text{ A}, -di_F/dt = 500\text{ A}/\mu\text{s} (T_{vj}=150^{\circ}\text{C})$ $V_R = 600\text{ V}$	$T_{vj} = 25^{\circ}\text{C}$		0,24		mJ
		$T_{vj} = 125^{\circ}\text{C}$		0,52		mJ
		$T_{vj} = 150^{\circ}\text{C}$		0,59		mJ
Wärmewiderstand, Chip bis Gehäuse Thermal resistance, junction to case	pro Diode / per diode	$R_{thJC}$		1,50	1,65	K/W
Wärmewiderstand, Gehäuse bis Kühlkörper Thermal resistance, case to heatsink	pro Diode / per diode $\lambda_{Paste} = 1\text{ W}/(\text{m}\cdot\text{K}) / \lambda_{grease} = 1\text{ W}/(\text{m}\cdot\text{K})$	$R_{thCH}$		1,20		K/W
Temperatur im Schaltbetrieb Temperature under switching conditions		$T_{vj\text{ op}}$	-40		150	$^{\circ}\text{C}$

**NTC-Widerstand / NTC-Thermistor**

**Charakteristische Werte / Characteristic Values**

			min.	typ.	max.	
Nennwiderstand Rated resistance	$T_C = 25^{\circ}\text{C}$	$R_{25}$		5,00		$\text{k}\Omega$
Abweichung von R100 Deviation of R100	$T_C = 100^{\circ}\text{C}, R_{100} = 493\ \Omega$	$\Delta R/R$	-5		5	%
Verlustleistung Power dissipation	$T_C = 25^{\circ}\text{C}$	$P_{25}$			20,0	mW
B-Wert B-value	$R_2 = R_{25} \exp [B_{25/50}(1/T_2 - 1/(298,15\text{ K}))]$	$B_{25/50}$		3375		K
B-Wert B-value	$R_2 = R_{25} \exp [B_{25/80}(1/T_2 - 1/(298,15\text{ K}))]$	$B_{25/80}$		3411		K
B-Wert B-value	$R_2 = R_{25} \exp [B_{25/100}(1/T_2 - 1/(298,15\text{ K}))]$	$B_{25/100}$		3433		K

Angaben gemäß gültiger Application Note.  
Specification according to the valid application note.

prepared by: DK	date of publication: 2013-11-05
approved by: MB	revision: 2.0



**Vorläufige Daten  
Preliminary Data**

**Modul / Module**

Isolations-Prüfspannung Isolation test voltage	RMS, f = 50 Hz, t = 1 min.	V <sub>ISOL</sub>	2,5		kV
Innere Isolation Internal isolation	Basisisolation (Schutzklasse 1, EN61140) basic insulation (class 1, IEC 61140)		Al <sub>2</sub> O <sub>3</sub>		
Kriechstrecke Creepage distance	Kontakt - Kühlkörper / terminal to heatsink Kontakt - Kontakt / terminal to terminal		12,7 6,3		mm
Luftstrecke Clearance	Kontakt - Kühlkörper / terminal to heatsink Kontakt - Kontakt / terminal to terminal		8,5 5,0		mm
Vergleichszahl der Kriechwegbildung Comperative tracking index		CTI	> 200		
			min.	typ.	max.
Modulstreuinduktivität Stray inductance module		L <sub>SCE</sub>		30	nH
Modulleitungswiderstand, Anschlüsse - Chip Module lead resistance, terminals - chip	T <sub>c</sub> = 25°C, pro Schalter / per switch	R <sub>CC'+EE'</sub> R <sub>AA'+CC'</sub>		4,00 6,00	mΩ
Lagertemperatur Storage temperature		T <sub>stg</sub>	-40		125 °C
Anzugsdrehmoment f. Modulmontage Mounting torque for modul mounting	Schraube M6 - Montage gem. gültiger Applikationsschrift Screw M6 - Mounting according to valid application note	M	8,00	-	9,00 Nm
Gewicht Weight		G		34	g

Der Strom im Dauerbetrieb ist auf 25A effektiv pro Anschlusspin begrenzt.  
The current under continuous operation is limited to 25A rms per connector pin.

prepared by: DK	date of publication: 2013-11-05
approved by: MB	revision: 2.0

**Vorläufige Daten**  
**Preliminary Data**

**Ausgangskennlinie IGBT, Wechselrichter (typisch)**  
**output characteristic IGBT, Inverter (typical)**

$I_C = f(V_{CE})$   
 $V_{GE} = 15\text{ V}$

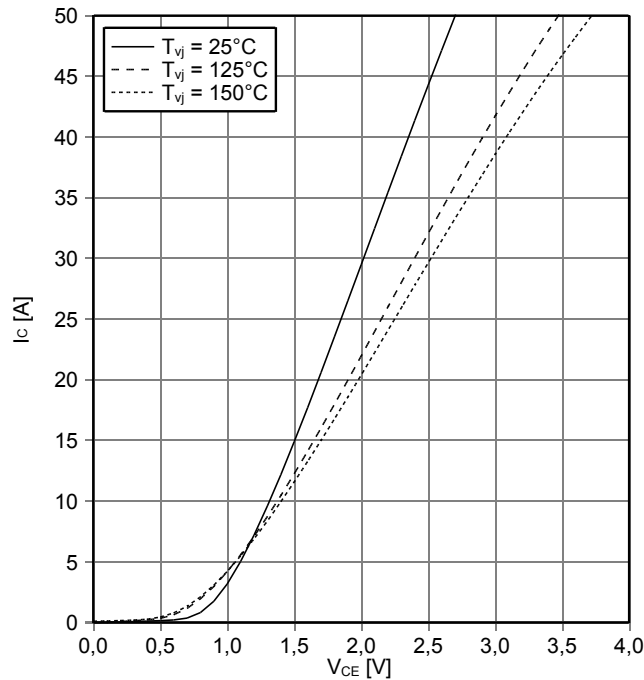

**Ausgangskennlinienfeld IGBT, Wechselrichter (typisch)**  
**output characteristic IGBT, Inverter (typical)**

$I_C = f(V_{CE})$   
 $T_{vj} = 150^\circ\text{C}$

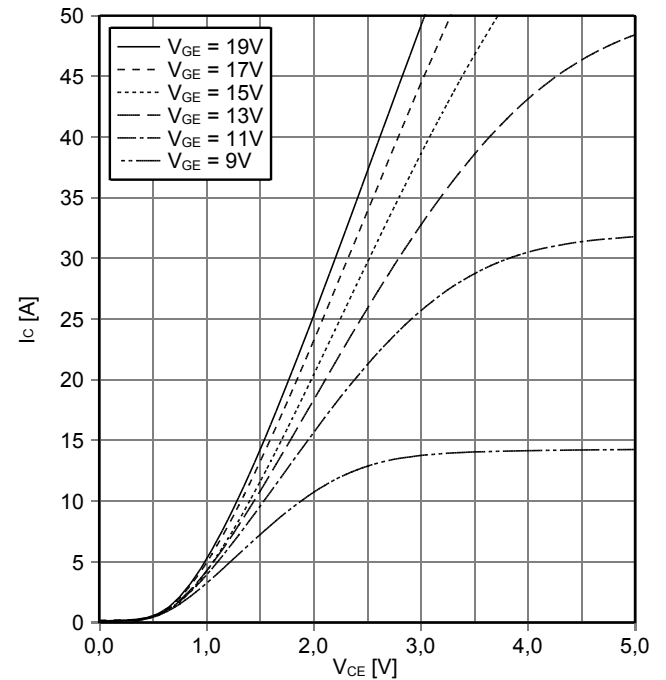

**Übertragungscharakteristik IGBT, Wechselrichter (typisch)**  
**transfer characteristic IGBT, Inverter (typical)**

$I_C = f(V_{GE})$   
 $V_{CE} = 20\text{ V}$

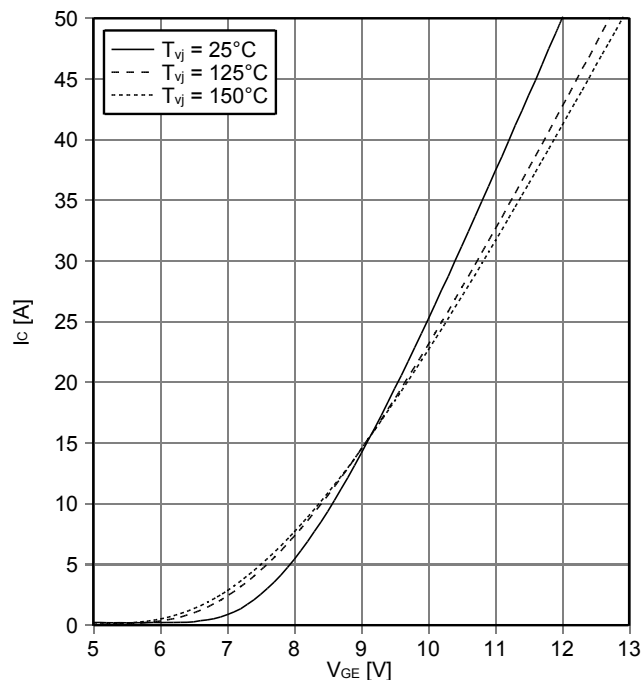

**Schaltverluste IGBT, Wechselrichter (typisch)**  
**switching losses IGBT, Inverter (typical)**

$E_{on} = f(I_C), E_{off} = f(I_C)$   
 $V_{GE} = \pm 15\text{ V}, R_{Gon} = 20\ \Omega, R_{Goff} = 20\ \Omega, V_{CE} = 600\text{ V}$

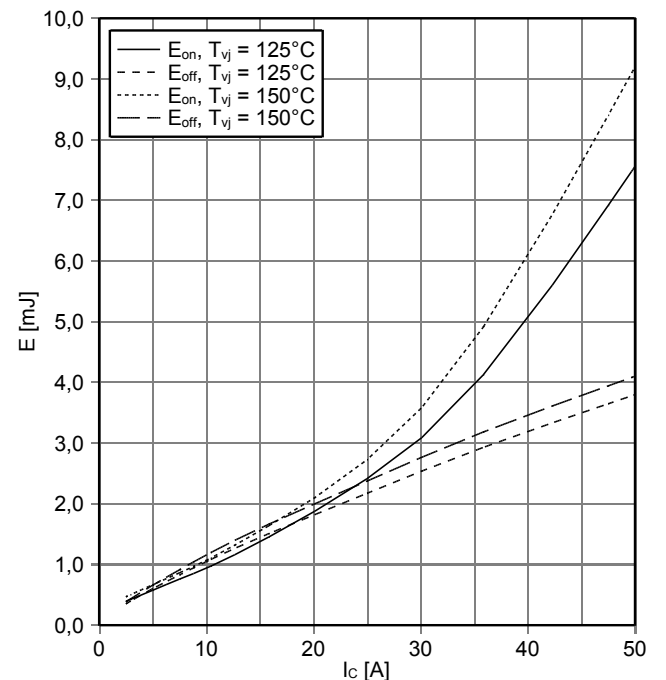

prepared by: DK	date of publication: 2013-11-05
approved by: MB	revision: 2.0



Vorläufige Daten  
Preliminary Data

Schaltverluste IGBT, Wechselrichter (typisch)  
switching losses IGBT, Inverter (typical)

$E_{on} = f(R_G)$ ,  $E_{off} = f(R_G)$   
 $V_{GE} = \pm 15\text{ V}$ ,  $I_C = 25\text{ A}$ ,  $V_{CE} = 600\text{ V}$

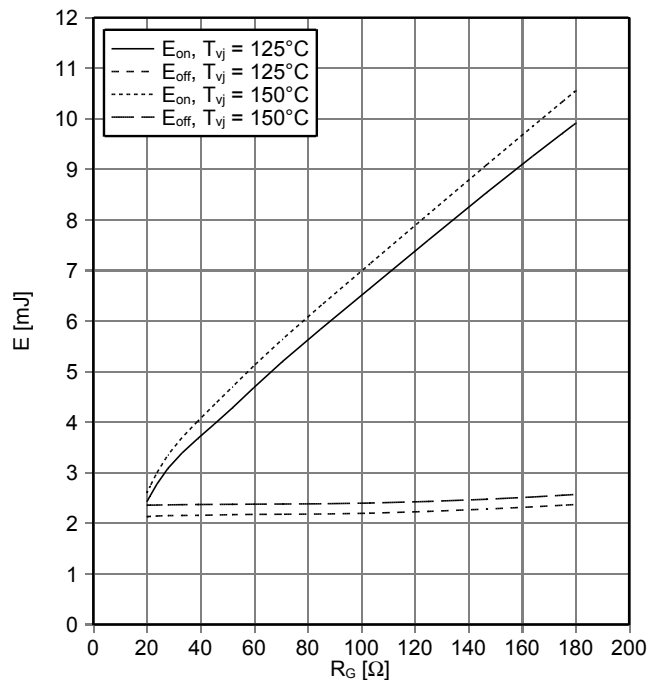

Transienter Wärmewiderstand IGBT, Wechselrichter  
transient thermal impedance IGBT, Inverter

$Z_{thJH} = f(t)$

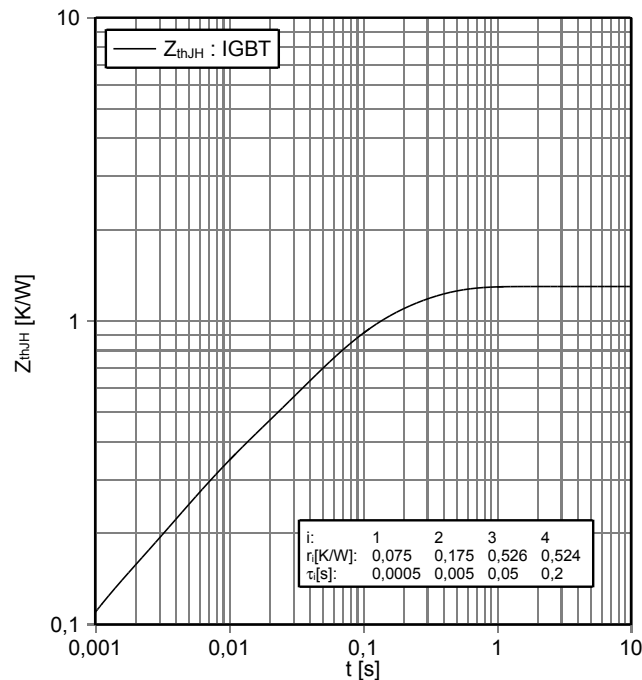

Sicherer Rückwärts-Arbeitsbereich IGBT, Wechselrichter  
(RBSOA)

reverse bias safe operating area IGBT, Inverter (RBSOA)

$I_C = f(V_{CE})$   
 $V_{GE} = \pm 15\text{ V}$ ,  $R_{Goff} = 20\ \Omega$ ,  $T_{vj} = 150^\circ\text{C}$

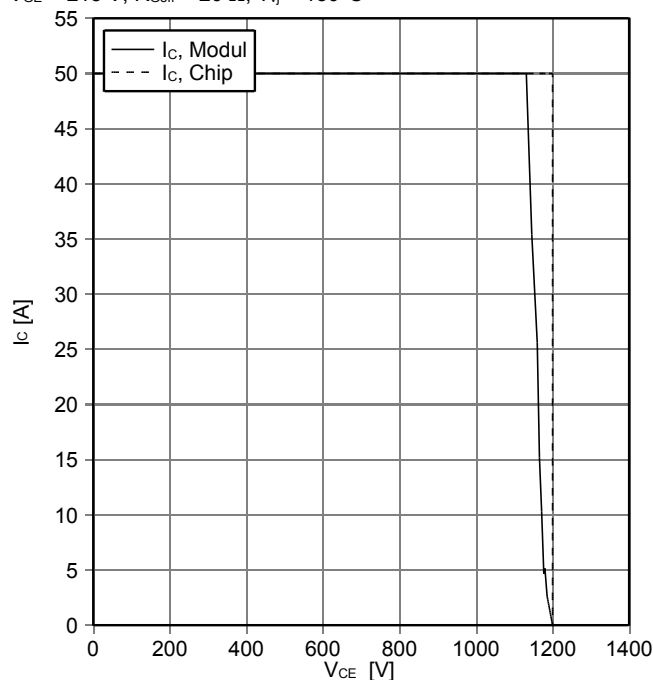

Durchlasskennlinie der Diode, Wechselrichter (typisch)  
forward characteristic of Diode, Inverter (typical)

$I_F = f(V_F)$

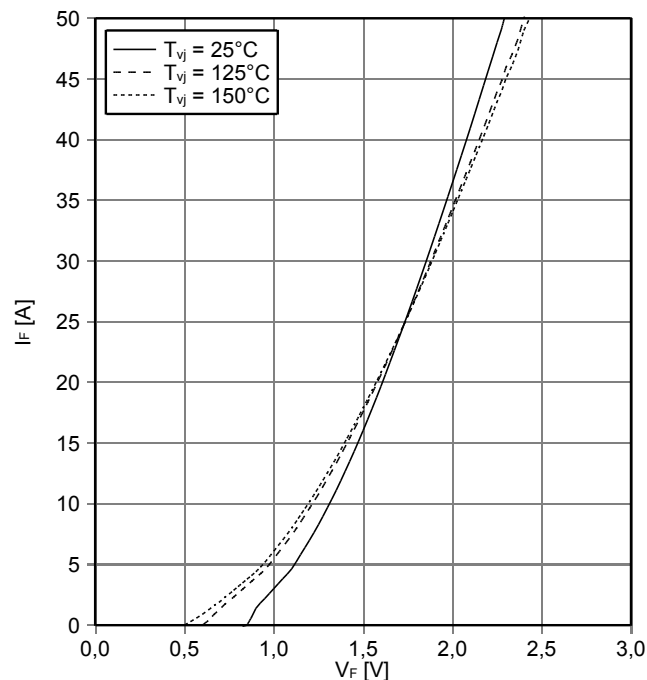

prepared by: DK	date of publication: 2013-11-05
approved by: MB	revision: 2.0



**Vorläufige Daten  
Preliminary Data**

**Schaltverluste Diode, Wechselrichter (typisch)  
switching losses Diode, Inverter (typical)**

$E_{rec} = f(I_F)$   
 $R_{Gon} = 20 \Omega, V_{CE} = 600 V$

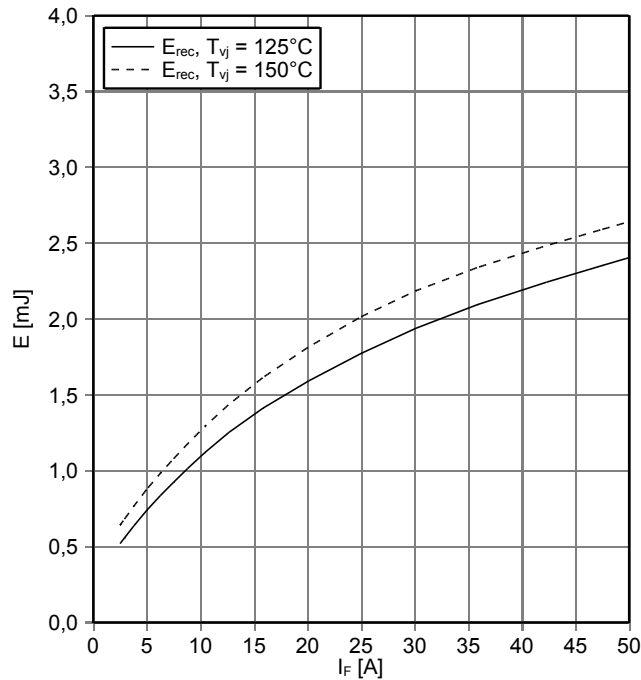

**Schaltverluste Diode, Wechselrichter (typisch)  
switching losses Diode, Inverter (typical)**

$E_{rec} = f(R_G)$   
 $I_F = 25 A, V_{CE} = 600 V$

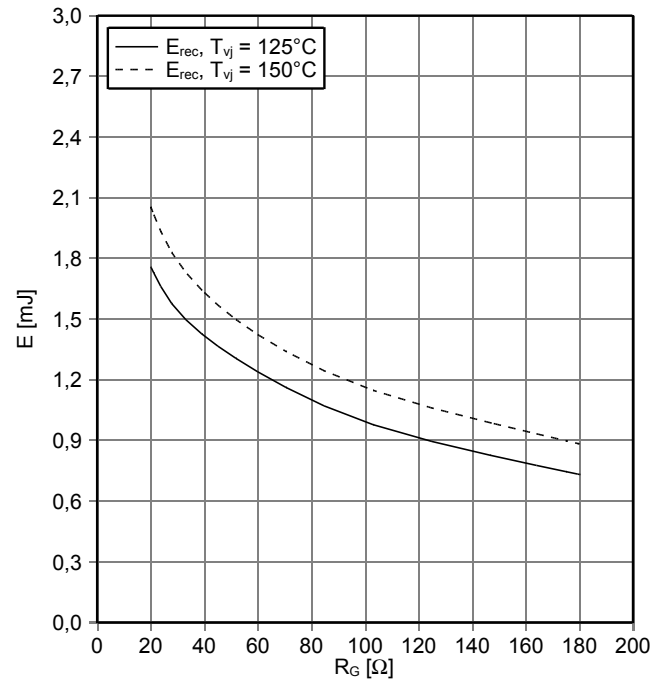

**Transienter Wärmewiderstand Diode, Wechselrichter  
transient thermal impedance Diode, Inverter**

$Z_{thJH} = f(t)$

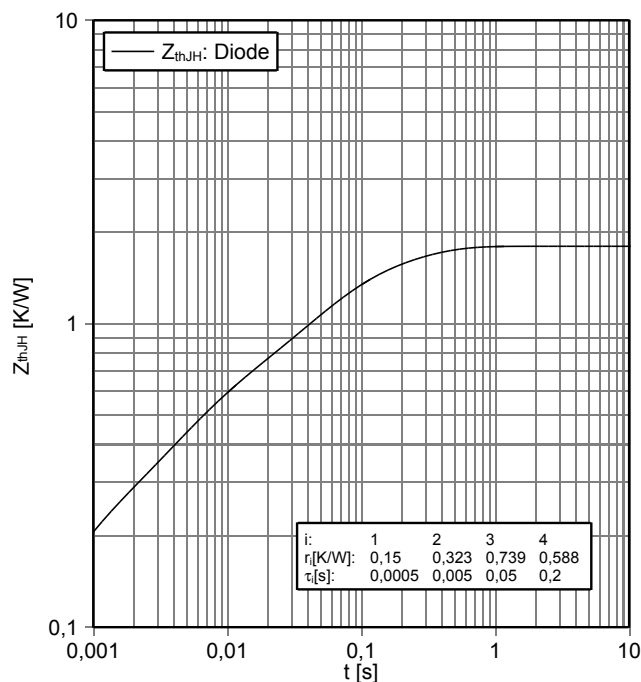

**Durchlasskennlinie der Diode, Gleichrichter (typisch)  
forward characteristic of Diode, Rectifier (typical)**

$I_F = f(V_F)$

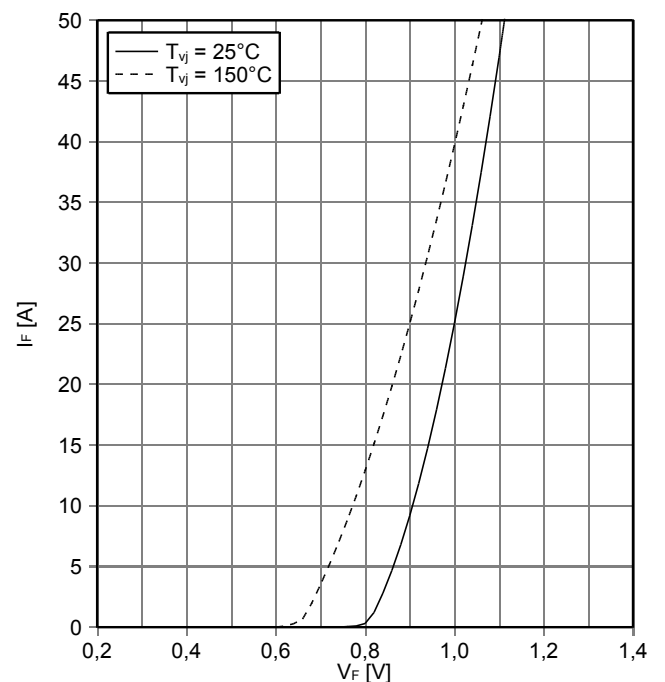

prepared by: DK	date of publication: 2013-11-05
approved by: MB	revision: 2.0



**Vorläufige Daten  
Preliminary Data**

**Ausgangskennlinie IGBT, Brems-Chopper (typisch)  
output characteristic IGBT, Brake-Chopper (typical)**

$I_C = f(V_{CE})$   
 $V_{GE} = 15\text{ V}$

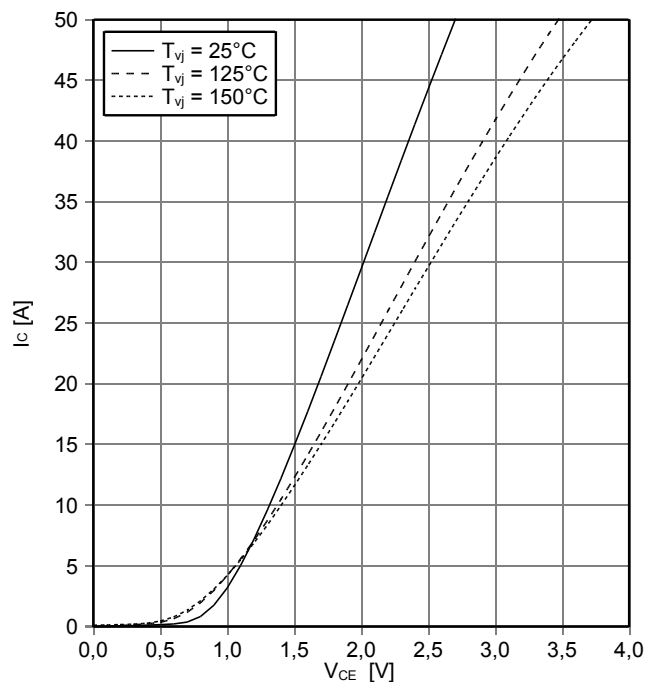

**Durchlasskennlinie der Diode, Brems-Chopper (typisch)  
forward characteristic of Diode, Brake-Chopper (typical)**

$I_F = f(V_F)$

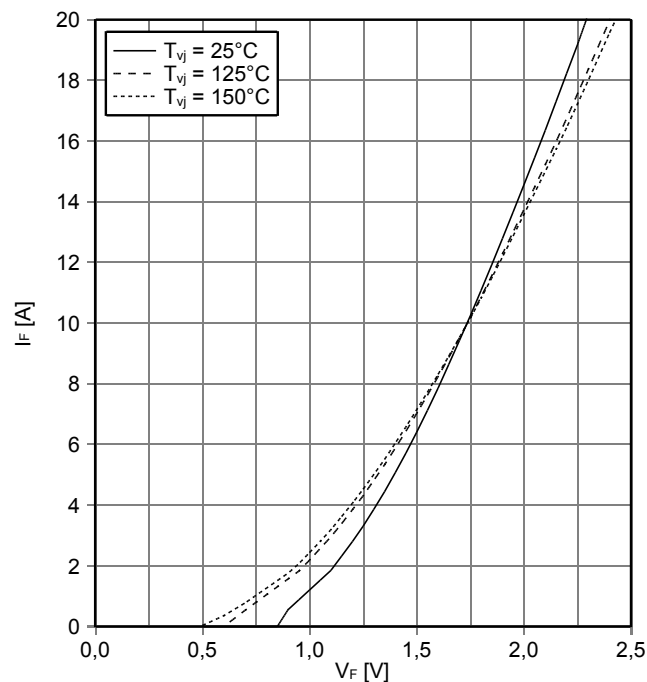

**NTC-Widerstand-Temperaturkennlinie (typisch)  
NTC-Thermistor-temperature characteristic (typical)**

$R = f(T)$

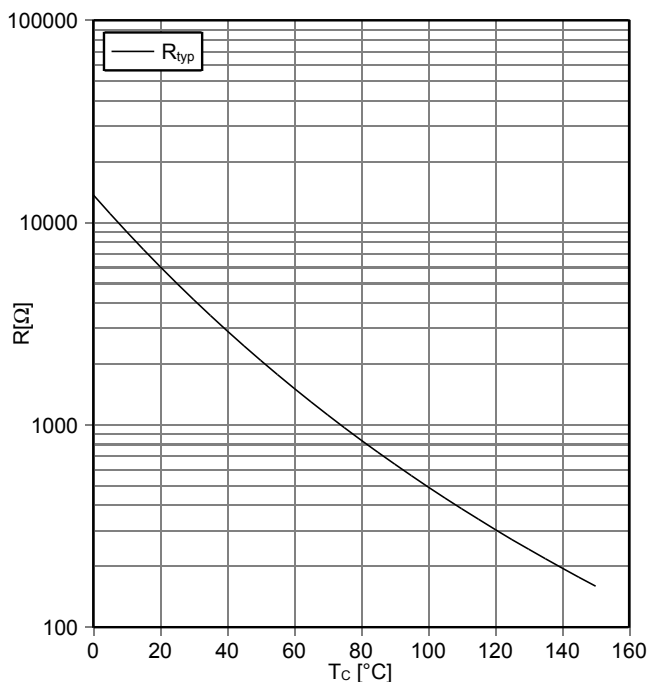

prepared by: DK	date of publication: 2013-11-05
approved by: MB	revision: 2.0

**Vorläufige Daten**  
**Preliminary Data**

**Schaltplan / circuit\_diagram\_headline**

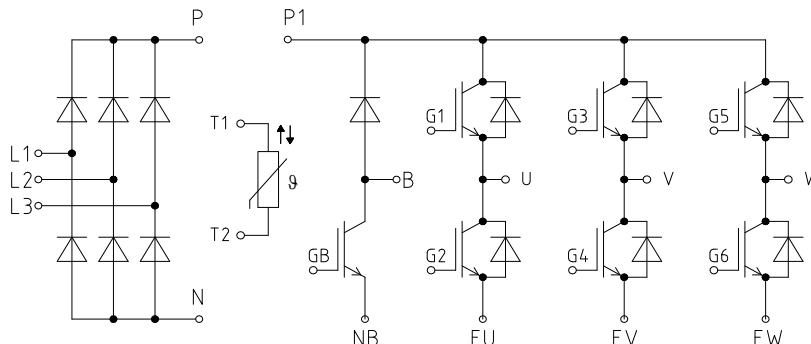

**Gehäuseabmessungen / package outlines**

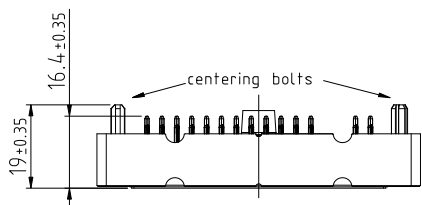
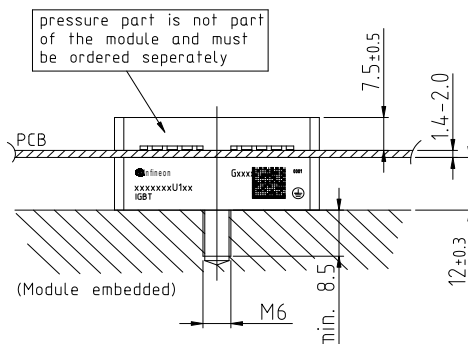
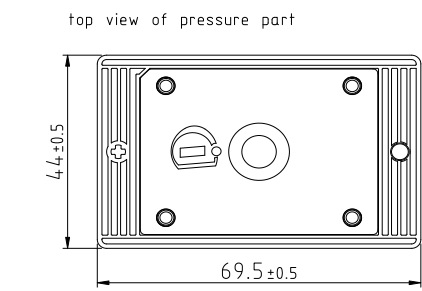

- Recommended screw:  
M6 counter sunk (acc. to ISO14581 or DIN7991)
- Pin-Grid 3.2mm
- Tolerance of PCB hole pattern  $\pm \varnothing 0.1$
- Hole specification for contacts see AN 2009-09  
Diameters of plated holes  $\varnothing 1.0\text{mm} \begin{matrix} +0.09 \\ -0.06 \end{matrix}$   
Diameters of drill  $\varnothing 1.15\text{mm}$

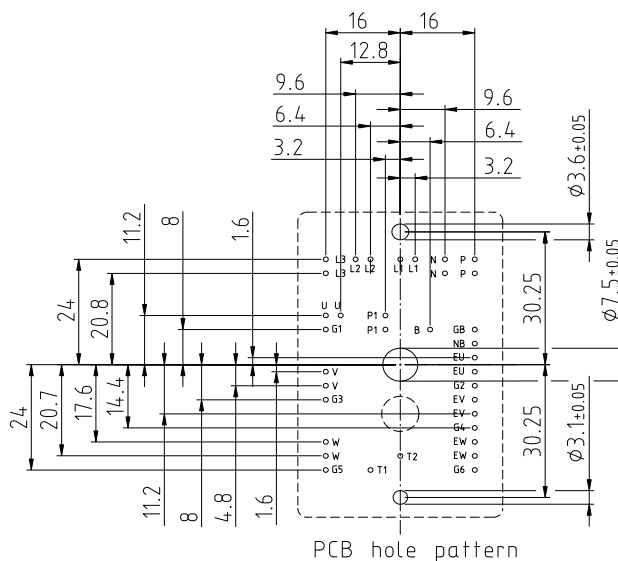
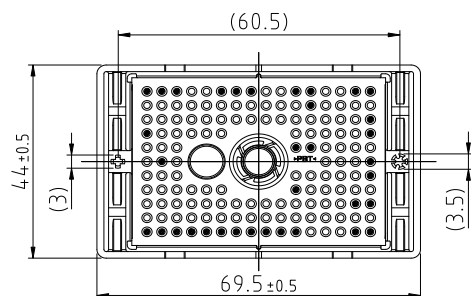

prepared by: DK	date of publication: 2013-11-05
approved by: MB	revision: 2.0

**Vorläufige Daten**  
**Preliminary Data**
**Nutzungsbedingungen**

Die in diesem Produktdatenblatt enthaltenen Daten sind ausschließlich für technisch geschultes Fachpersonal bestimmt. Die Beurteilung der Eignung dieses Produktes für Ihre Anwendung sowie die Beurteilung der Vollständigkeit der bereitgestellten Produktdaten für diese Anwendung obliegt Ihnen bzw. Ihren technischen Abteilungen.

In diesem Produktdatenblatt werden diejenigen Merkmale beschrieben, für die wir eine liefervertragliche Gewährleistung übernehmen. Eine solche Gewährleistung richtet sich ausschließlich nach Maßgabe der im jeweiligen Liefervertrag enthaltenen Bestimmungen. Garantien jeglicher Art werden für das Produkt und dessen Eigenschaften keinesfalls übernommen. Die Angaben in den gültigen Anwendungs- und Montagehinweisen des Moduls sind zu beachten.

Sollten Sie von uns Produktinformationen benötigen, die über den Inhalt dieses Produktdatenblatts hinausgehen und insbesondere eine spezifische Verwendung und den Einsatz dieses Produktes betreffen, setzen Sie sich bitte mit dem für Sie zuständigen Vertriebsbüro in Verbindung (siehe [www.infineon.com](http://www.infineon.com), Vertrieb&Kontakt). Für Interessenten halten wir Application Notes bereit.

Aufgrund der technischen Anforderungen könnte unser Produkt gesundheitsgefährdende Substanzen enthalten. Bei Rückfragen zu den in diesem Produkt jeweils enthaltenen Substanzen setzen Sie sich bitte ebenfalls mit dem für Sie zuständigen Vertriebsbüro in Verbindung.

Sollten Sie beabsichtigen, das Produkt in Anwendungen der Luftfahrt, in gesundheits- oder lebensgefährdenden oder lebenserhaltenden Anwendungsbereichen einzusetzen, bitten wir um Mitteilung. Wir weisen darauf hin, dass wir für diese Fälle

- die gemeinsame Durchführung eines Risiko- und Qualitätsassessments;
- den Abschluss von speziellen Qualitätssicherungsvereinbarungen;
- die gemeinsame Einführung von Maßnahmen zu einer laufenden Produktbeobachtung dringend empfehlen und gegebenenfalls die Belieferung von der Umsetzung solcher Maßnahmen abhängig machen.

Soweit erforderlich, bitten wir Sie, entsprechende Hinweise an Ihre Kunden zu geben.

Inhaltliche Änderungen dieses Produktdatenblatts bleiben vorbehalten.

**Terms & Conditions of usage**

The data contained in this product data sheet is exclusively intended for technically trained staff. You and your technical departments will have to evaluate the suitability of the product for the intended application and the completeness of the product data with respect to such application.

This product data sheet is describing the characteristics of this product for which a warranty is granted. Any such warranty is granted exclusively pursuant the terms and conditions of the supply agreement. There will be no guarantee of any kind for the product and its characteristics. The information in the valid application- and assembly notes of the module must be considered.

Should you require product information in excess of the data given in this product data sheet or which concerns the specific application of our product, please contact the sales office, which is responsible for you ( see [www.infineon.com](http://www.infineon.com) ). For those that are specifically interested we may provide application notes.

Due to technical requirements our product may contain dangerous substances. For information on the types in question please contact the sales office, which is responsible for you.

Should you intend to use the Product in aviation applications, in health or live endangering or life support applications, please notify. Please note, that for any such applications we urgently recommend

- to perform joint Risk and Quality Assessments;
- the conclusion of Quality Agreements;
- to establish joint measures of an ongoing product survey, and that we may make delivery depended on the realization of any such measures.

If and to the extent necessary, please forward equivalent notices to your customers.

Changes of this product data sheet are reserved.

prepared by: DK	date of publication: 2013-11-05
approved by: MB	revision: 2.0