

Cross LED Corncob Bulb



The Cross Corncob from Beyond LED Technology is one of the most energy efficient product of 2021, as they are designed primarily to substitute the HID lamps and metal halide bulbs. Cross corn lights are named for their design which resembles the corn on the cob. These luminaries are the dimmable, wattage-adjustable corn bulbs designed for fully enclosed fixtures, while maintaining a high Lumen output and up to 140 lumens per watt efficacy. These high-output LEDs are ideal for parking lots, post top lights, streetlighting, shoebox fixtures, highway lighting, and other high intensity lighting.



SKU #	Model #	Base	Watts	Lumens	CCT	IP	Dimmable	Input Voltage	Certifications
153464	BLT-CLW08E-036WXYA1-adcK	E26	Adjustable 18W/27W/36W	2550Lm- 5120Lm	5000K	IP64	0-10V	100V-277V	UL & DLC
153465	BLT-CLW08E-063WXYA1-adcK	EX39	Adjustable 45W/54W/63W	6390Lm- 8950Lm	5000K	IP64	0-10V	100V-277V	UL & DLC
153466	BLT-CLW08E-120WXYA1-adcK	EX39	Adjustable 80W/100W/120W	11360Lm- 17040Lm	5000K	IP64	0-10V	100V-277V	UL & DLC

Product Features

- Operating temperature: -40°C to 50°C
- Enclosure provides a water-tight seal making it suitable for outdoor application
- Integral LED driver (non-isolated), eliminates the need for an external driver or ballast
- Up to 140 lumens per watt
- Three selectable wattages
- Complies with UL safety regulations and is DLC5.1 listed
- High Quality and Efficacy Lumiled 2835 chips
- This product is IP64 rated, therefore, it is waterproof and dust proof rating
- Universal operation at 120-277Vac 50-60Hz
- Environment friendly with no mercury
- Easy to install and operate, with instant and no humming
- Energy saving, long lifespan
- 4KV built-in surge protector and fan-less design
- Direct replacement for Metal Halide

SKU Number 153464 Specifications

Parameter	Description	Value
General Performance	Input Power	Up to 36W Wattage adjustable 18W /27W /36W
	Lumen	Up to 5120LM
	Lumen Efficacy	Up to 140LM/W
	Color Temperature	5000K
	CRI	>80
	Diffuser Type	Clear
Electrical	Beam Angle (50%) (Tolerance: ±15%)	210 Degree
	Input Voltage	120-277VAC 50/60Hz
	PF	≥0.9
	THD	≤20%
Physical	Equivalent	80W CFL, 150W MHL/HPS/HID
	Driver Surge protection	L-N: 4kV
	Dimming	0-10V dimming standard
	Operating Temperature	-40°C TO 50°C
	Storage Temperature	-40°C TO 80°C
	Operating Humidity	20% - 70% RH
	Storage Humidity	10% - 75% RH
	LED Brand	LUMILEDS
	LED Type	SMD 2835
Qualification	LED QTY	144 PCS
	Housing	PC + Aluminum
	Housing Color	White
	Waterproof Rating	WET (IP64)
	Warranty Time	5 Years



SKU Number 153465 Specifications

Parameter	Description	Value
General Performance	Input Power	Up to 63W Wattage adjustable 45W /54W /63W
	Lumen	Up to 8950LM
	Lumen Efficacy	Up to 140LM/W
	Color Temperature	5000K
	CRI	>80
	Diffuser Type	Clear
Electrical	Beam Angle (50%) (Tolerance : ±15%)	182 Degree
	Input Voltage	120-277VAC 50/60Hz
	PF	≥0.9
	THD	≤20%
Physical	Equivalent	120W CFL, 175W MHL/HPS/HID
	Driver Surge protection	L-N: 4kV
	Dimming	0-10V dimming standard
	Operating Temperature	-40°C TO 50°C
	Storage Temperature	-40°C TO 80°C
	Operating Humidity	20% - 70% RH
	Storage Humidity	10% - 75% RH
	LED Brand	LUMILEDS
	LED Type	SMD 2835
	Qualification	LED QTY
Housing		PC + Aluminum
Housing Color		White
Waterproof Rating		WET (IP64)
Warranty Time		5 Years

SKU Number 153466 Specifications

Parameter	Description	Value
General Performance	Input Power	Up to 120W Wattage adjustable 80W /100W /120W
	Lumen	Up to 17040LM
	Lumen Efficacy	Up to 140LM/W
	Color Temperature	5000K
	CRI	>80
	Diffuser Type	Clear
Electrical	Beam Angle (50%) (Tolerance : ±15%)	150 Degree
	Input Voltage	120-277VAC 50/60Hz
	PF	≥0.9
	THD	≤20%
Physical	Equivalent	200W CFL, 400W MHL/HPS/HID
	Driver Surge protection	L-N: 6kV
	Dimming	0-10V dimming standard
	Operating Temperature	-40°C TO 50°C
	Storage Temperature	-40°C TO 80°C
	Operating Humidity	20% - 70% RH
	Storage Humidity	10% - 75% RH
	LED Brand	LUMILEDS
	LED Type	SMD 2835
Qualification	LED QTY	494 PCS
	Housing	PC + Aluminum
	Housing Color	White
	Waterproof Rating	WET (IP64)
	Warranty Time	5 Years



Correlated Color Temperature (CCT)

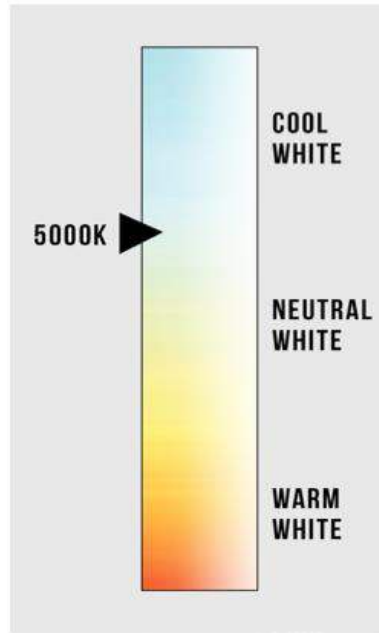

Dimensions

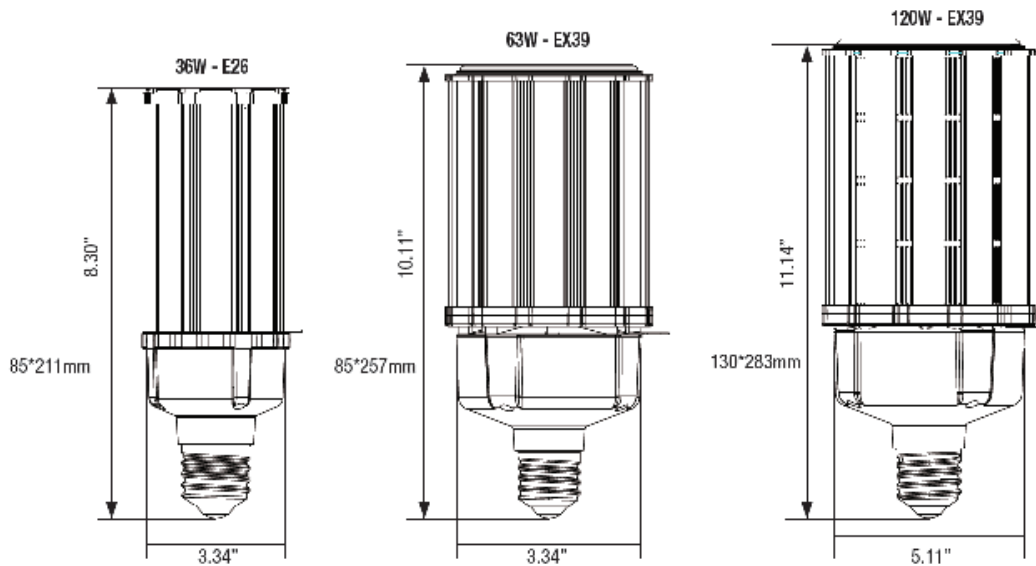

SKU number 153464 Light Distribution Testing Parameters

Luminaire Data

Voltage: 120.0 V
 Current: 0.289 A
 Power: 34.09 W
 Power Factor: 0.98

Photometric Results

IES Classification: Type I
 Total Rated Lamp Lumens: 4249.1 lm
 Efficiency: 100%
 Upward Ratio: 25%
 C0r0 Intensity: 116.17 cd

Longitudinal Classification: Short
 Measurement Flux: 4249.1 lm
 Downward Ratio: 75%
 Luminaire Efficacy Rating (LER): 124.69
 Max. Intensity: 766.58 cd



Luminous Intensity Distribution Curve

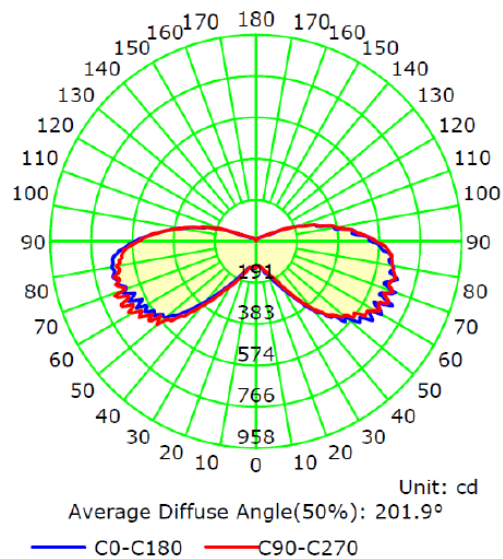

The Average Illuminance Effective Figure

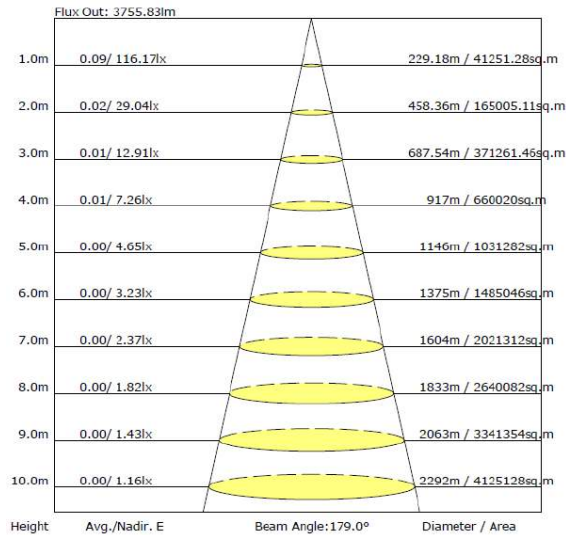

SKU number 153465 Light Distribution Testing Parameters

Luminaire Data

Voltage: 120.0 V
 Current: 0.53 A
 Power: 62.92 W
 Power Factor: 0.99

Photometric Results

IES Classification: Type I
 Total Rated Lamp Lumens: 7700.3 lm
 Efficiency: 100%
 Upward Ratio: 19%
 C0r0 Intensity: 253.75 cd

Longitudinal Classification: Short
 Measurement Flux: 7700.3 lm
 Downward Ratio: 81%
 Luminaire Efficacy Rating (LER): 122.43
 Max. Intensity: 1555.56 cd

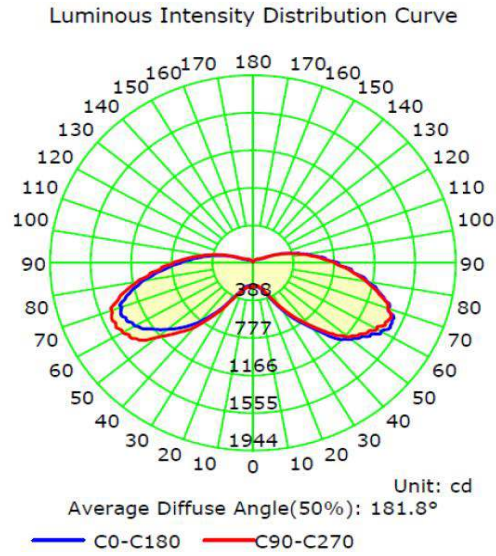

The Average Illuminance Effective Figure

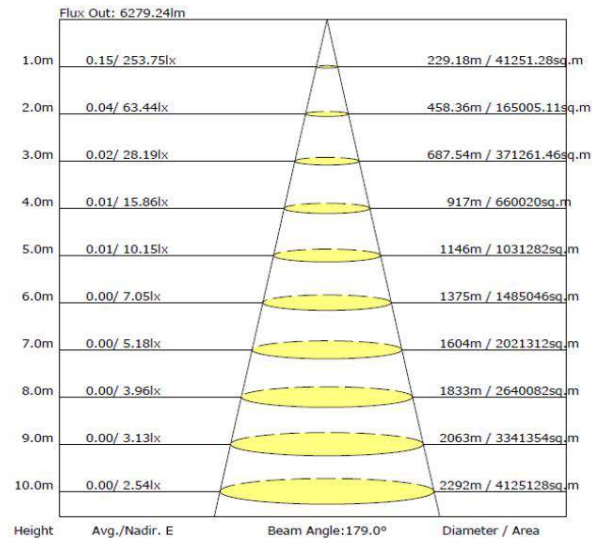

SKU Number 153466 Light Distribution Testing Parameters

Luminaire Data

Voltage: 120.0 V
Current: 1.02 A
Power: 121.21 W
Power Factor: 0.99

Photometric Results

CIE Class: Direct
 Measurement Flux: 14835.9 lm
 Downward Ratio: 97%
 Field Angle(C0/C180,C90/C270,C45/C225,C135/315): 191.3, 191.4, 191.9, 190.7
 Beam Angle(C0/C180,C90/C270,C45/C225,C135/315): 146.9, 148.3, 148.1, 145.7
 Luminaire Efficacy Rating (LER): 122.45
 Total Rated Lamp Lumens: 14835.9 lm
 Efficiency: 100%
 Upward Ratio: 3%
 C0r0 Intensity: 1442.33 cd

Luminous Intensity Distribution Curve

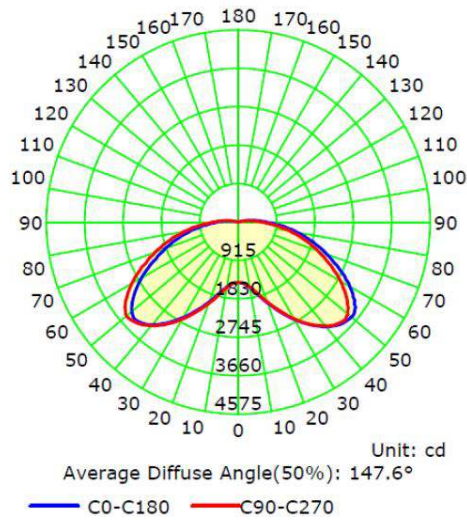

The Average Illuminance Effective Figure

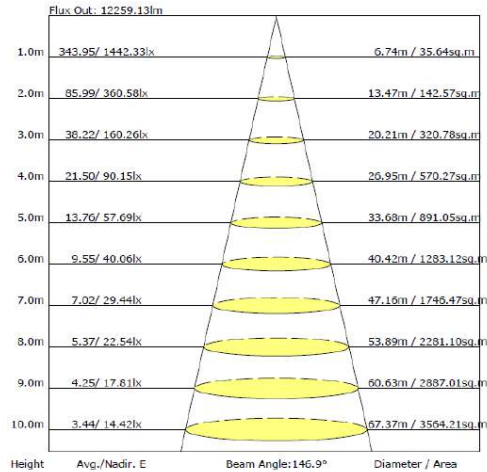

Notes Before Installation

1. Be careful to open the carton, contact us if any damage.
2. This product must be installed in accordance with the applicable installation, code by a person familiar with the construction and operation of the product and the hazards involved.
3. "caution - risk of shock" and "disconnect power before servicing" when photoelectric switch provided.
4. Please check whether the voltage marked on the luminaire is consistent with the input voltage to be connected, so as not to damage the LED luminaire.
5. To ensure the lifetime of the product, please do not use it in a place with strong acid mist.
6. Make sure the installation position can withstand 10 times the weight of the luminaire before installation and install it at a flat place without vibration, no swing, no fire hazard.

Caution

1. Do not use an electric generator to test the LED fixture.
2. Please abide by related country, regional and local law and regulations when install this fixture;
3. Do not install the fixture in raining days to avoid electrical shock or damage.

Notes for Users

Please turn off power before install or change assembly parts.

The input voltage and lamps should be matched, after connecting the power line, please make sure the wiring section is insulated.

Make sure to remove or bypass the ballast in the fixtures before install the lamps.

Suitable for damp locations. Do not use with dimmers.

Product under SKU number 153464 is suitable for use in enclosed luminaires, min. lamp compartment dimensions: 14.96*7.87*7.87inches.

Product under SKU number 153465 is suitable for use in enclosed luminaires, min. lamp compartment dimensions: 16.54*9.06*9.06inches.

Product under SKU number 153466 is suitable for use in enclosed luminaires, min. lamp compartment dimensions: 17.32*10.24*10.24inches.

Non-professionals must not install and disassemble the lamps.



Caution

1. This luminaire must be installed by qualified electrician to avoid electric shock and fire accident;
2. Wear gloves before installation in order to avoid injury;
3. Turn off the power immediately when there is smoke and fire during installation, inform professionals to overhaul;
4. This luminaire is suitable for outdoor use.

Installation Instructions

1. Turn off the power switch.
2. Screw off the CFL or MHL or HPS and so on, see Figure (5)(6).
3. Take out led corn light and screw on, see Figure (1)(2)(3)(4).

Figure (1)(2) (3) (4):AC internal driver,

(Note: Pls make sure to take off the ballast before installing led corn light, otherwise the ballast will produce the resonance of high voltage and makes led corn light breakdown.)

4. If security rope provided, pls fix the rope on the lamp with hand, then fix the wire of other end on the shell, see Figure(2) (4).
5. Lamp CCT and dimming can be adjusted after removing the top plastic cover with a screwdriver. Figure(5) (8)
6. Turn on the power switch. (Finished!)

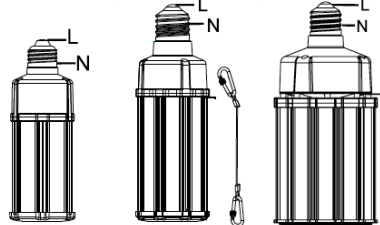

Figure(1) Figure(2) Figure(3)



Figure(4)

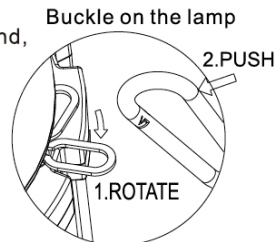

Buckle on the lamp

2.PUSH

1.ROTATE

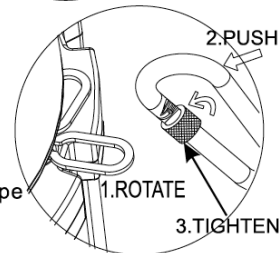

2.PUSH

1.ROTATE

3.TIGHTEN

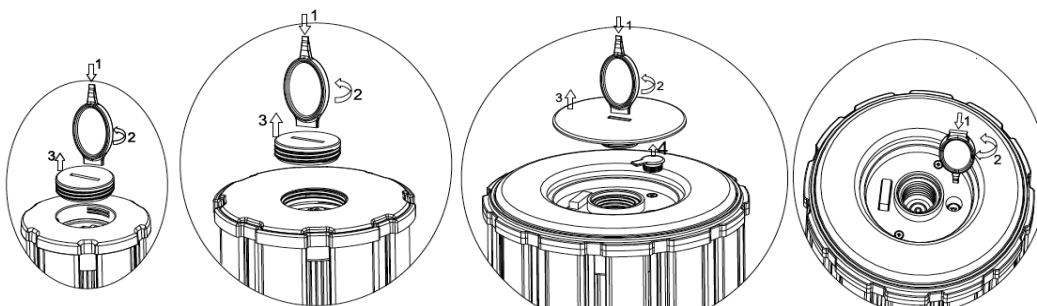

Figure(5)

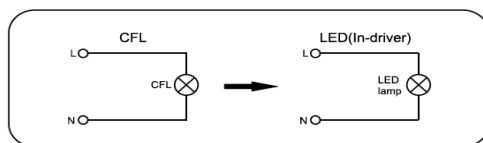

Figure(6)

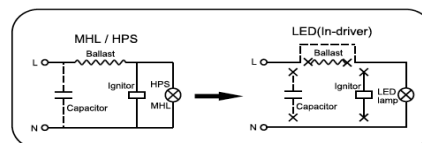

Figure(7)

Dimming Mode Diagram

**** Please improve the presentation of the figure below, compile all four into one figure, captioned with "Figure (8)" ****

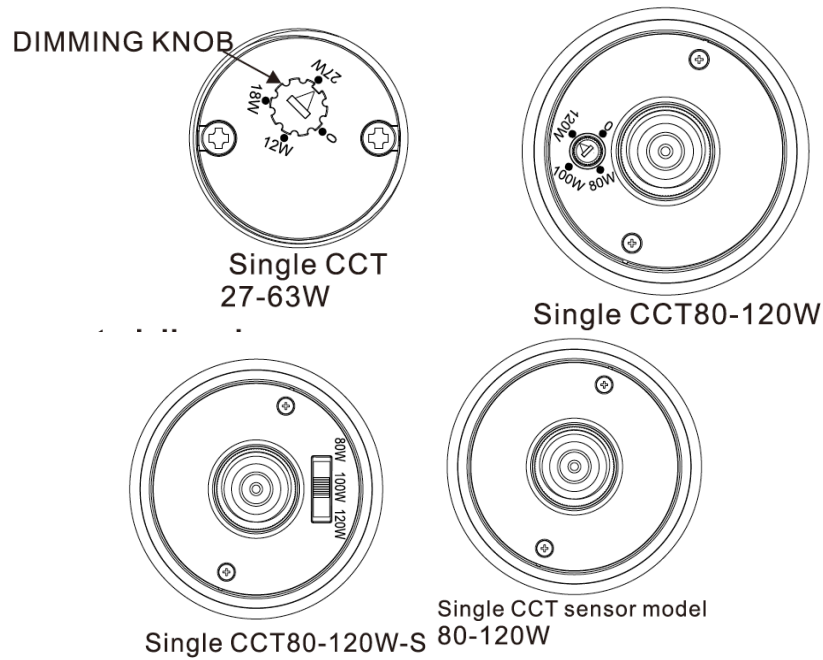

Trouble Shooting

Troubles	Check points
Flickering of the light	Turn off the power and turn on again in 3 minutes. If same phenomena occur, then call agencies.
Out of working	Please check the connection.

Packaging

For SKU number 153464

	Size (Inches)	Qty	Net Weight (lbs)	Gross Weight (lbs)
Inner Box	3.54*3.54*9.65	1 PC	1.23	1.56
Outer box	14.96*11.42*10.43	12 PCS	14.99	20.94

For SKU number 153465

	Size (Inches)	Qty	Net Weight (lbs)	Gross Weight (lbs)
Inner Box	3.54*3.54*11.60	1 PC	1.54	1.98
Outer box	14.96*11.42*12.40	12 PCS	17.42	24.91

For SKU number 153466

	Size (Inches)	Qty	Net Weight (lbs)	Gross Weight (lbs)
Inner Box	5.31*5.31*12.40	1 PC	3.42	3.64
Outer box	16.53*11.22*13.19	6 PCS	20.50	24.03

Tolerance of Carton Size: ± 15 MM, Tolerance of Weight: $\pm 10\%$.

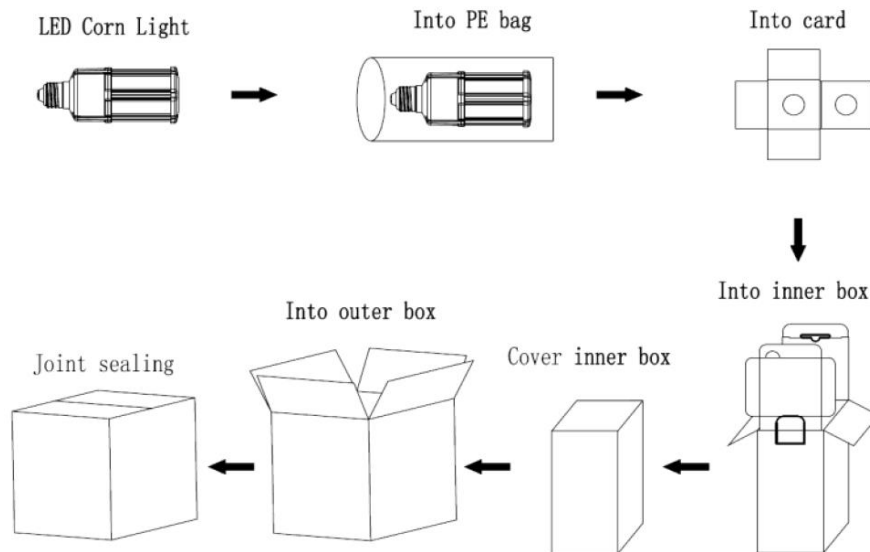

Application

Replacement Lamps for Outdoor Pole/Arm-mounted Decorative Luminaires (Type B). Widely used in supermarket, warehouse, garage, home, office, hotel, hospital, school, street, garden etc.





Safety Precautions

To reduce the risk of death, personal injury or property damage from fire, electric shock, falling parts, cuts/abrasions, and other hazards read all warnings and instructions included with and on the fixture box and all fixture labels.

Before installing, servicing, or performing routine maintenance upon this equipment, follow these general precautions.

Commercial installation, service and maintenance of luminaires should be performed by a qualified licensed electrician.

For the installation: If you are unsure about the installation or maintenance of the luminaires, consult a qualified licensed electrician and check your local electrical code.

To prevent wiring damage or abrasion, do not expose wiring to edges of sheet metal or other sharp objects. Do not make or alter any open holes in an enclosure of wiring or electrical components during kit installation.

WARNING: RISK OF FIRE OR ELECTRICAL SHOCK

Turn off electrical power at fuse or circuit breaker box before wiring fixture to the power supply.

Turn off the power when you perform any maintenance.

Verify that supply voltage is correct by comparing it with the luminaire label information.

Make all electrical and grounded connections in accordance with the National Electrical Code and any applicable local code requirements. All wiring connections should be capped with UL approved wire connectors.

CAUTION: RISK OF INJURY

Avoid direct eye exposure to the light source while it is on.

Account for small parts and destroy packing material, as these may be hazardous to children.

Warranty

5 Years Warranty.

