

**PLUG MATED TO R/A RECEPTACLE
MATED PROFILE**

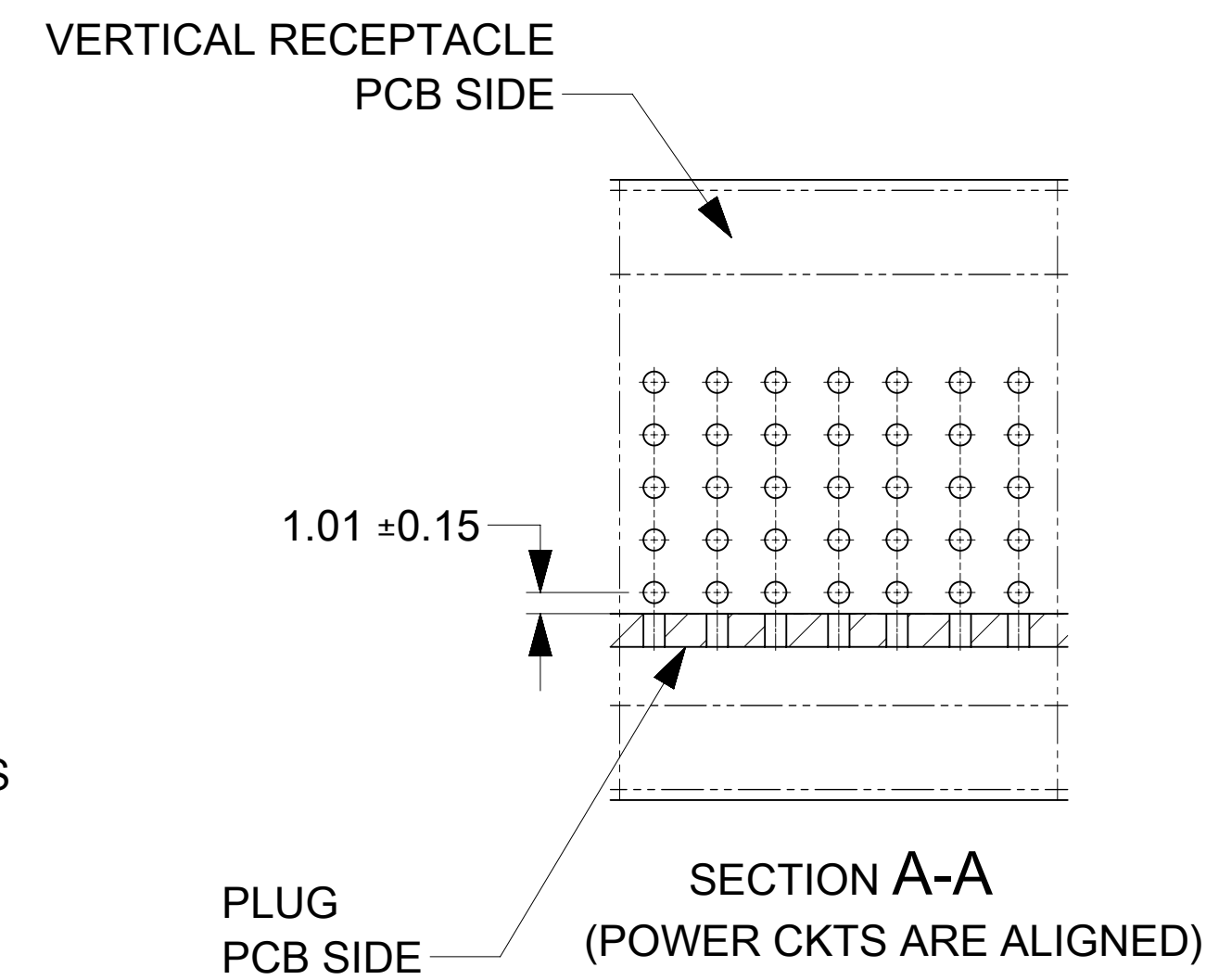

**PLUG MATED TO VERTICAL RECEPTACLE
MATED PROFILE**

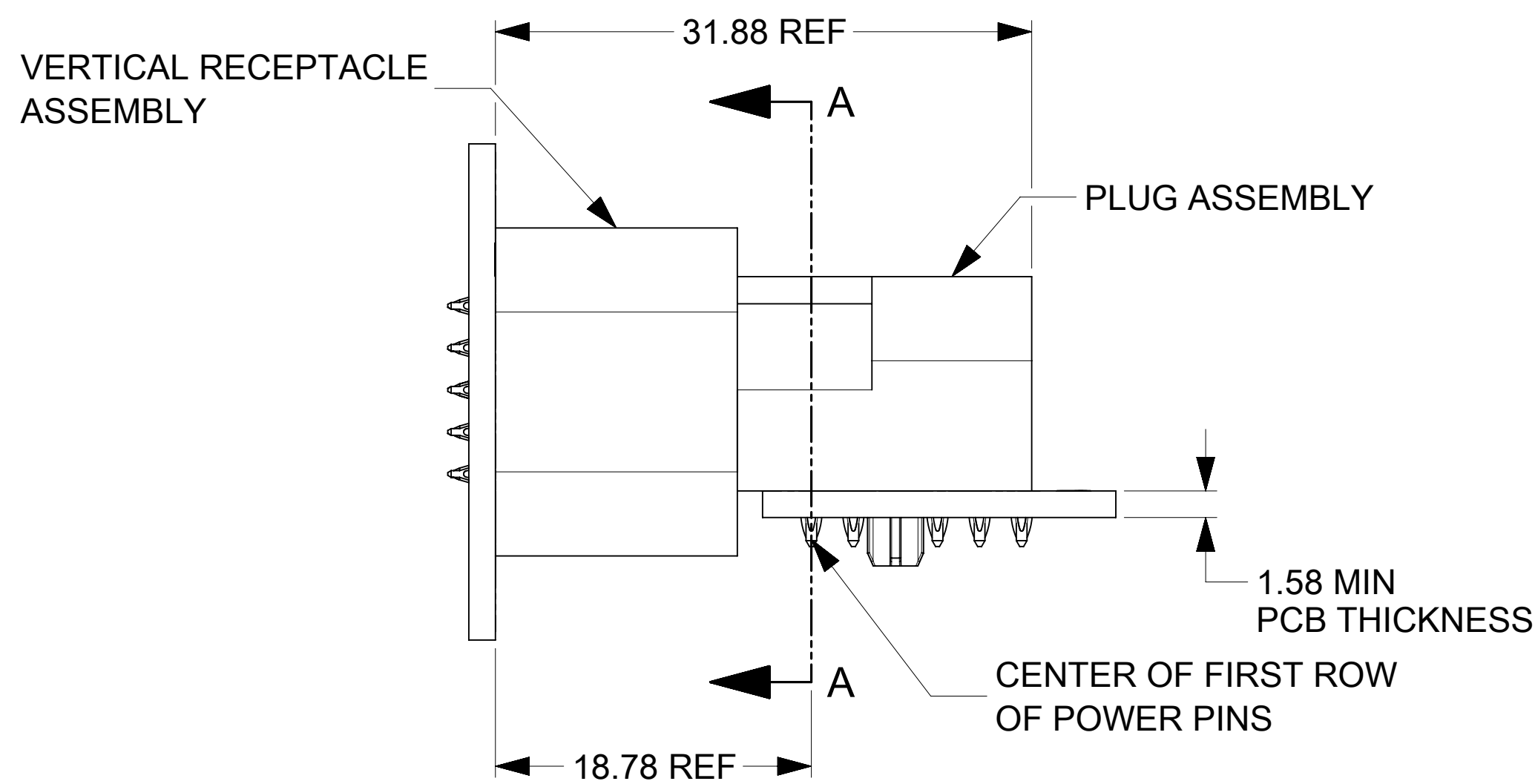
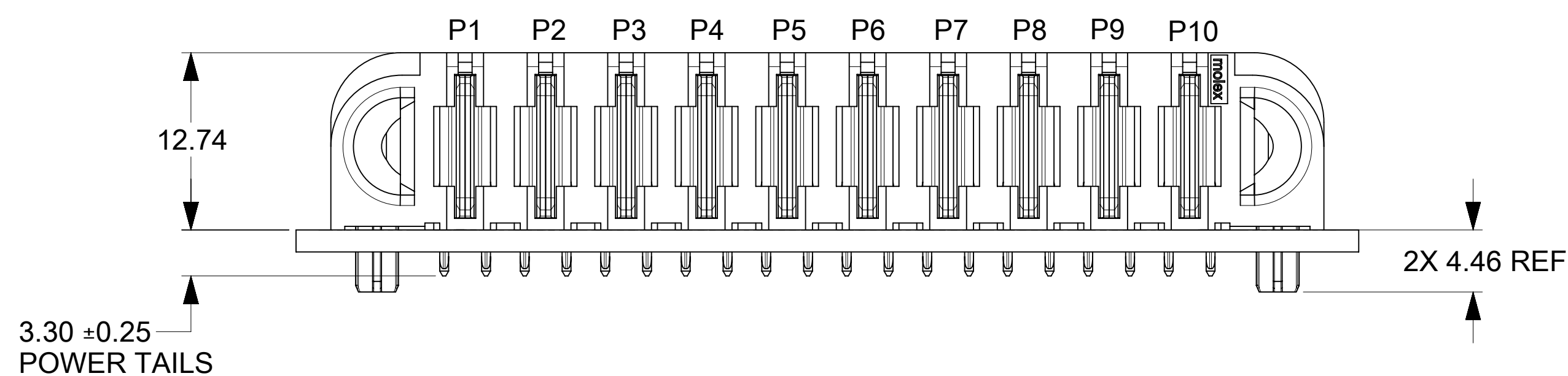
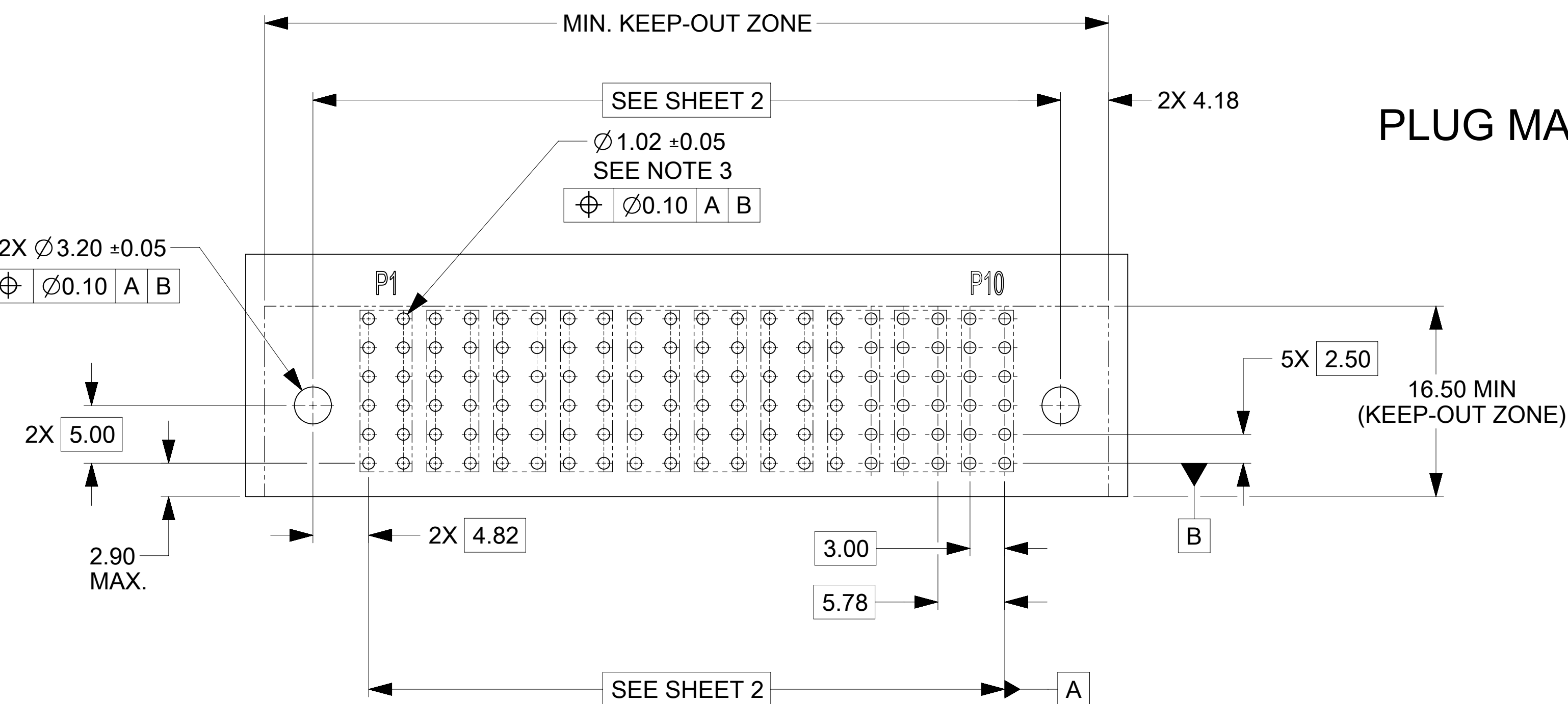

NOTES:

- MATERIAL:**
 -HOUSINGS: LCP UL94, V-0, COLOR : BLACK
 -TERMINALS: HIGH CONDUCTIVITY COPPER ALLOY
 -PLATING: 1.27 μm (50 μin) NICKEL OVERALL WITH
 2.54 μm (100 μin) SELECTIVE TIN ON TAILS AND
 0.762 μm (30 μin) SELECTIVE GOLD ON CONTACT AREA
- PACKAGING:** ASSEMBLIES TO BE TRAY PACKED PER PACKAGING SPEC: 2141130010-PK.
- PLATED THRU HOLE SIZE,** REFER TO PRODUCT SPEC. FOR DETAILS.
- PRODUCT SPEC:** 2141130000-PS.
- PRODUCT TO MEET** RoHS REQUIREMENTS.
- PLUG ASSEMBLY MATES TO MOLEX RECEPTACLES** 219563XXXX-SD AND 219564XXXX-SD, SEE DRAWINGS FOR DETAILS.
- TAIL DESIGN:** COMPLIANT PIN.
- POWER TERMINALS ARE LUBRICATED.**
- APPLICATION SPECIFICATION:** 2141130000-AS (FOR COMPLIANT TAILS ONLY).

THIS DRAWING CONTAINS INFORMATION THAT IS PROPRIETARY TO MOLEX ELECTRONIC TECHNOLOGIES, LLC AND SHOULD NOT BE USED WITHOUT WRITTEN PERMISSION			
DIMENSION UNITS	SCALE	CURRENT REV DESC:	
mm	3:1		
GENERAL TOLERANCES (UNLESS SPECIFIED)			
ANGULAR TOL	± °		
4 PLACES	±	EC NO: 745288	
3 PLACES	±	DRWN: LZABJANOVSKI	2023/03/09
2 PLACES	± 0.25	CHK'D: JAYK1	2023/04/10
1 PLACE	± 0.3	APPR: JAYK1	2023/04/10
0 PLACES	±	INITIAL REVISION:	
DRAFT WHERE APPLICABLE MUST REMAIN WITHIN DIMENSIONS		DRWN: LZABJANOVSKI	2022/03/14
		APPR: BPISZCZOR	2022/08/04
THIRD ANGLE PROJECTION	DRAWING	SERIES	MATERIAL NUMBER
	D-SIZE	219562	SEE CHART
		CUSTOMER	SHEET NUMBER
			1 OF 2

RECOMMENDED PCB LAYOUT AND KEEP-OUT ZONE



GUARDIAN HD RA PLUG POWER ONLY PF

PRODUCT CUSTOMER DRAWING

DOCUMENT NUMBER	DOC TYPE	DOC PART	REVISION
2195629000-SD	PSD	000	A1

PART NUMBER	CONFIGURATION	QUANTITY PER CARTON (DU)
219562-0001	G+1P+G	195

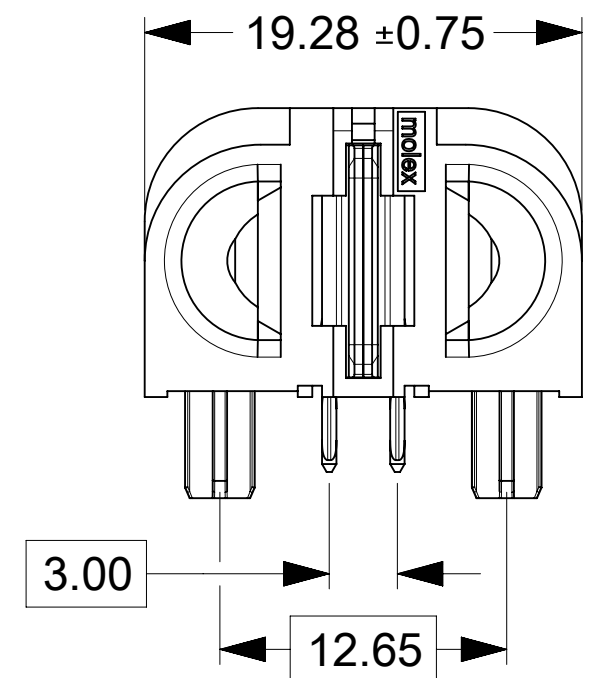

PART NUMBER	CONFIGURATION	QUANTITY PER CARTON (DU)
219562-0002	G+2P+G	150

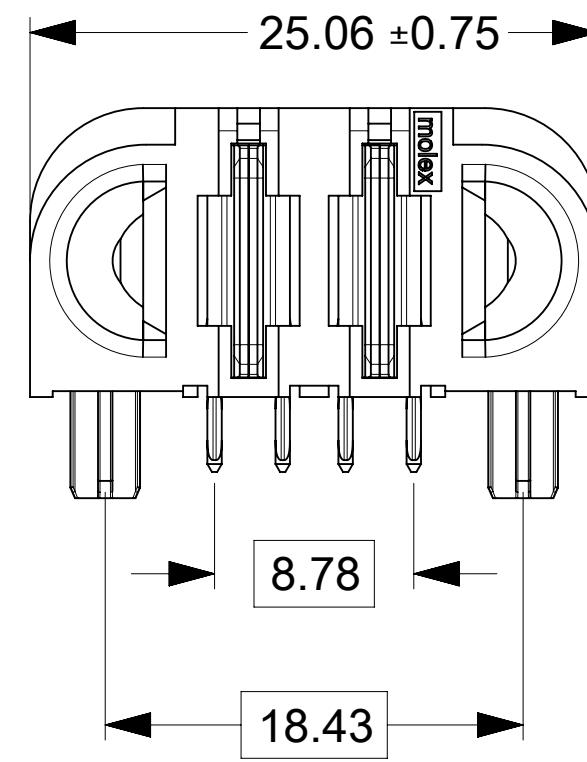

PART NUMBER	CONFIGURATION	QUANTITY PER CARTON (DU)
219562-0003	G+3P+G	120

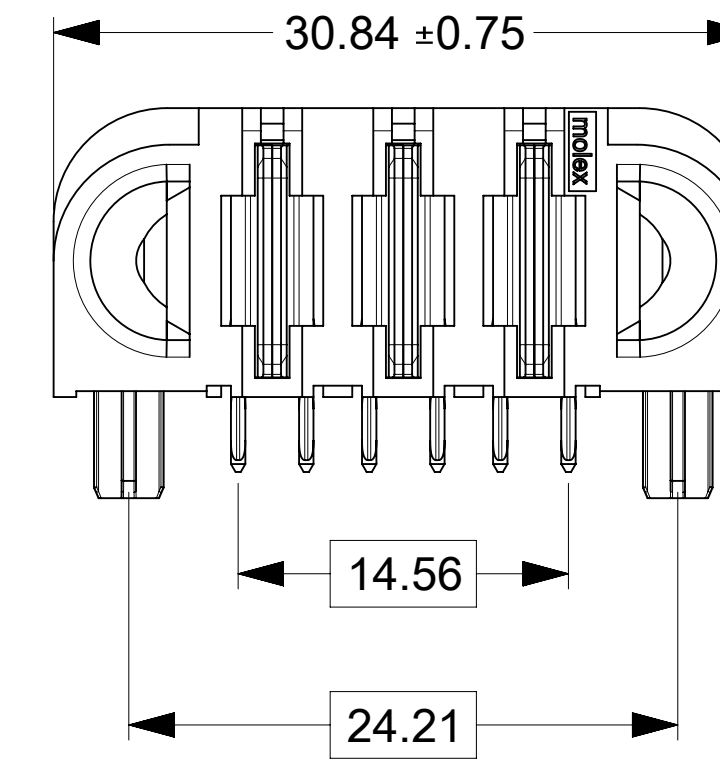

PART NUMBER	CONFIGURATION	QUANTITY PER CARTON (DU)
219562-0004	G+4P+G	105

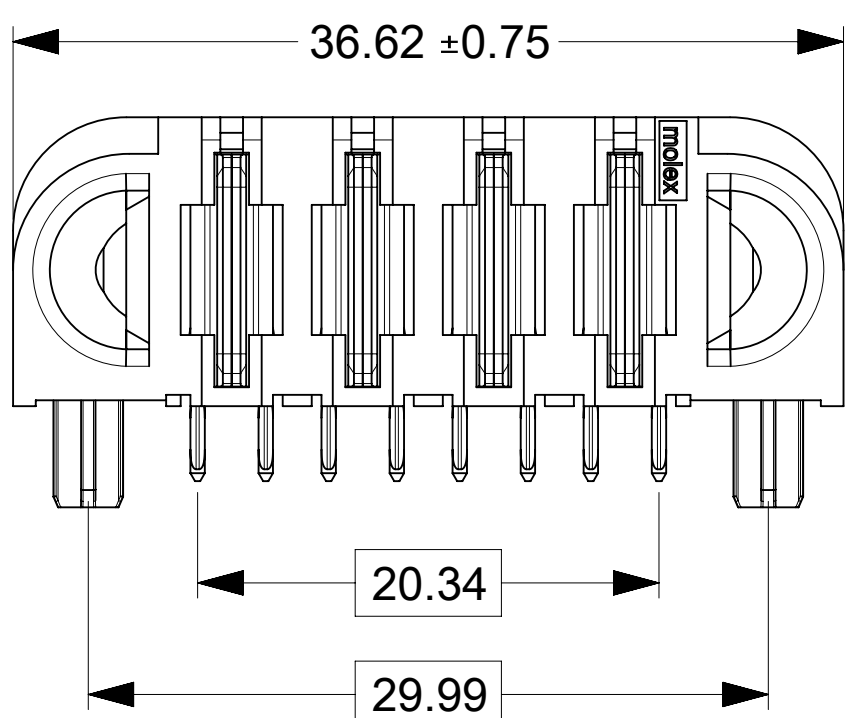

PART NUMBER	CONFIGURATION	QUANTITY PER CARTON (DU)
219562-0005	G+5P+G	90

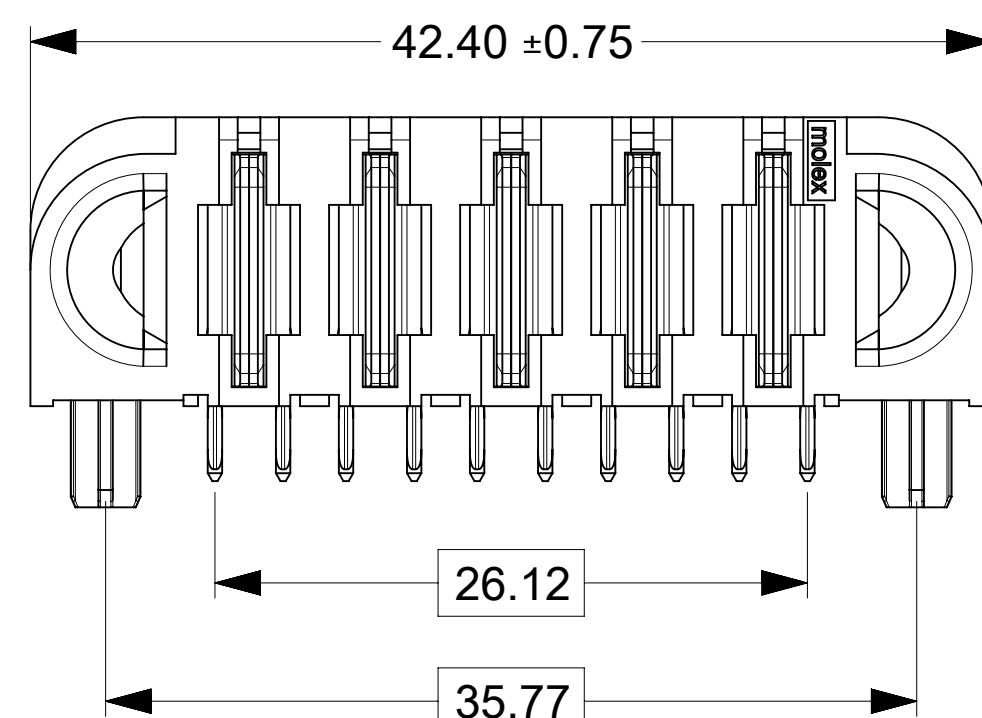

PART NUMBER	CONFIGURATION	QUANTITY PER CARTON (DU)
219562-0006	G+6P+G	75

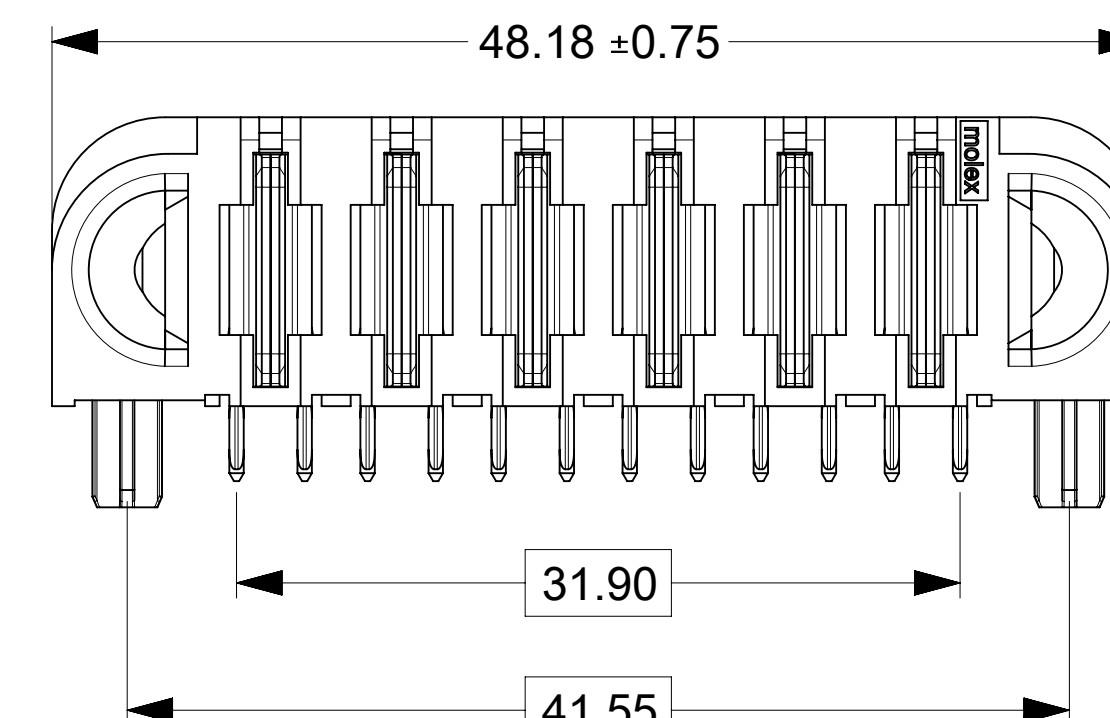

PART NUMBER	CONFIGURATION	QUANTITY PER CARTON (DU)
219562-0007	G+7P+G	60

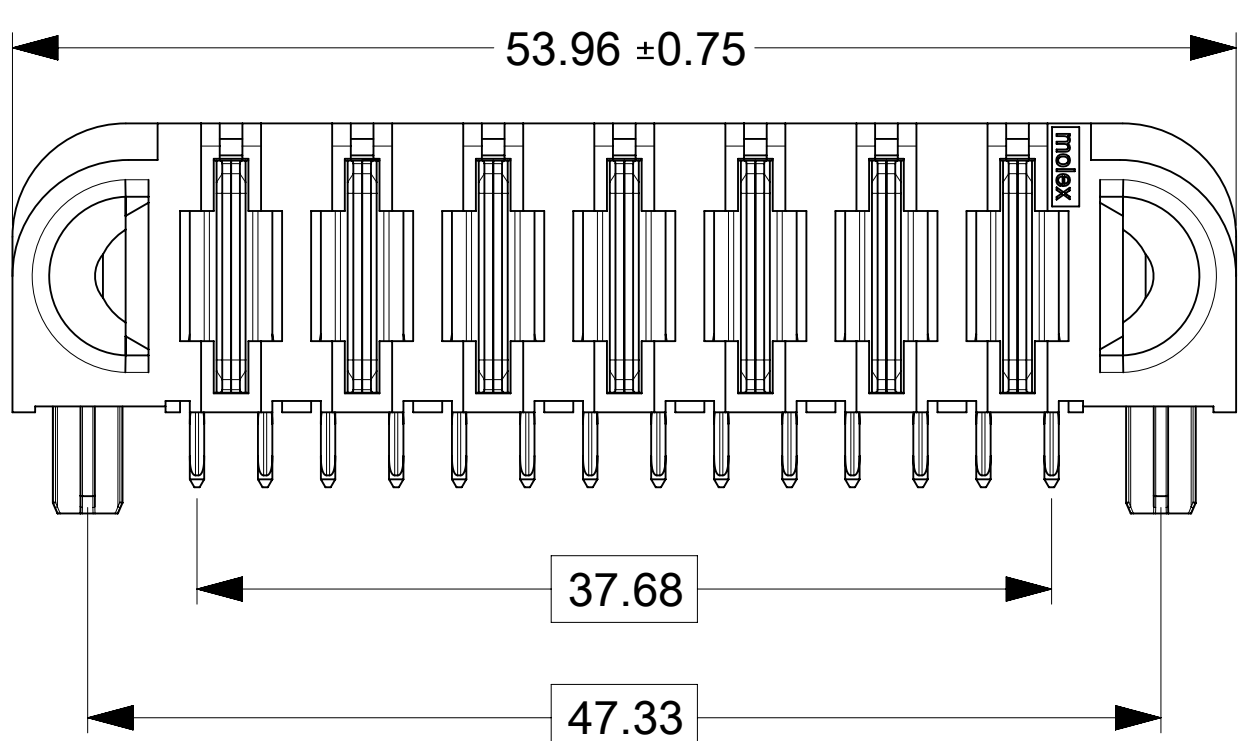

PART NUMBER	CONFIGURATION	QUANTITY PER CARTON (DU)
219562-0008	G+8P+G	60

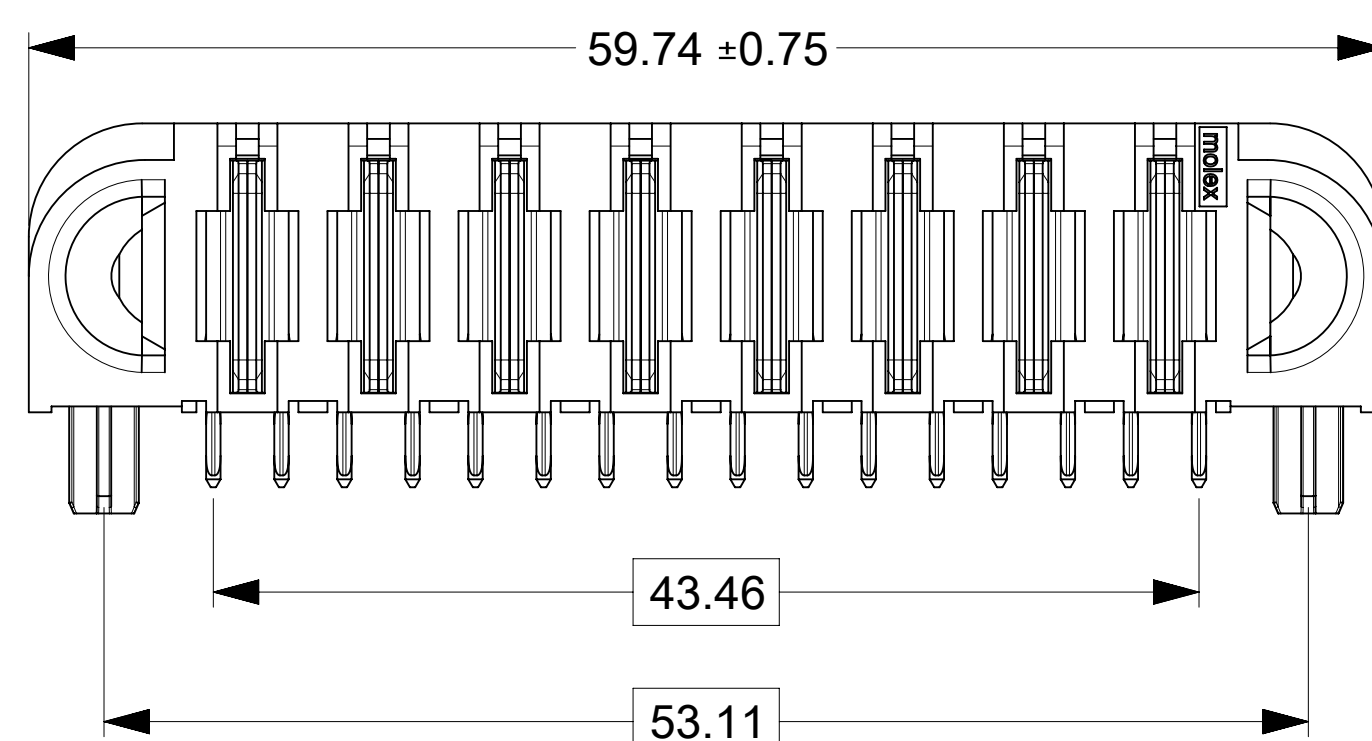

PART NUMBER	CONFIGURATION	QUANTITY PER CARTON (DU)
219562-0009	G+9P+G	45

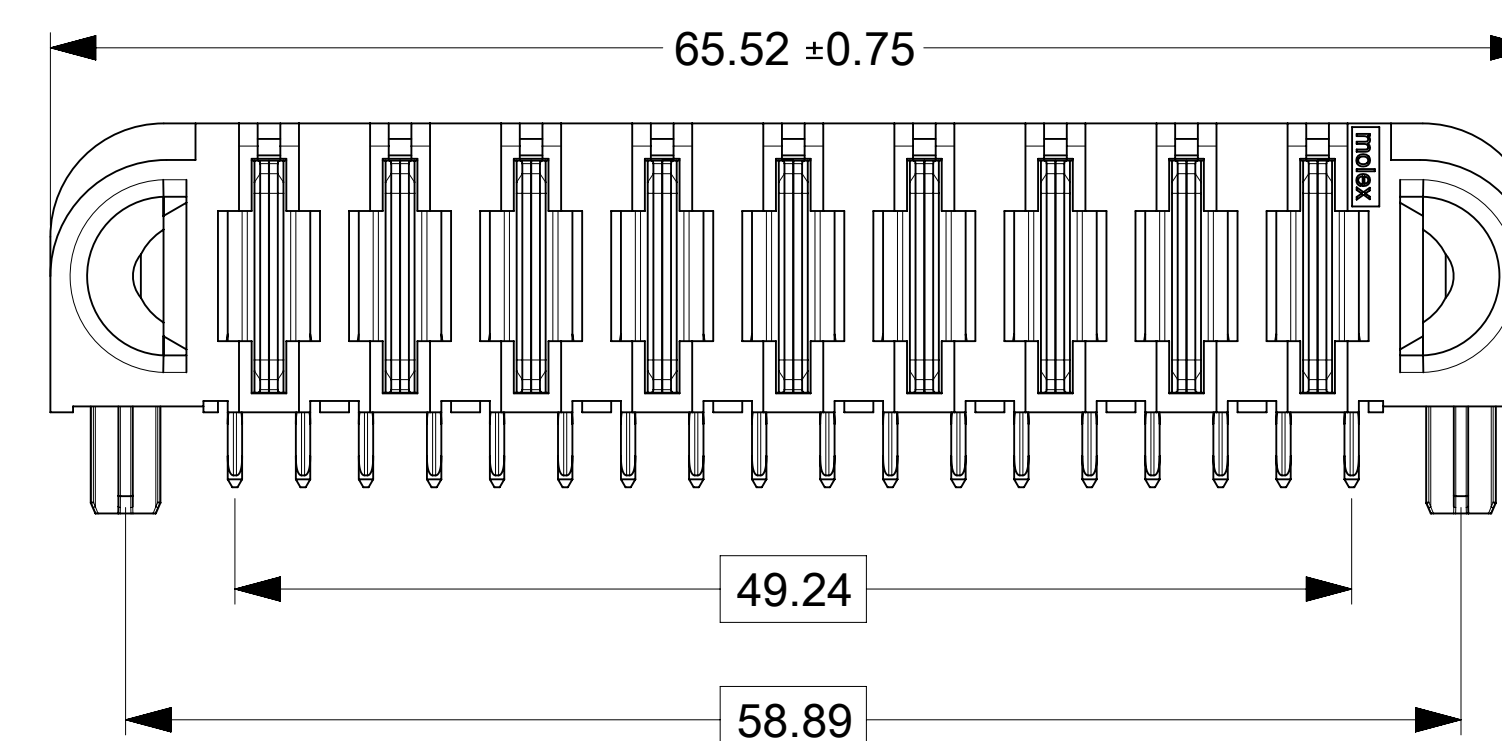

PART NUMBER	CONFIGURATION	QUANTITY PER CARTON (DU)
219562-0010	G+10P+G	45

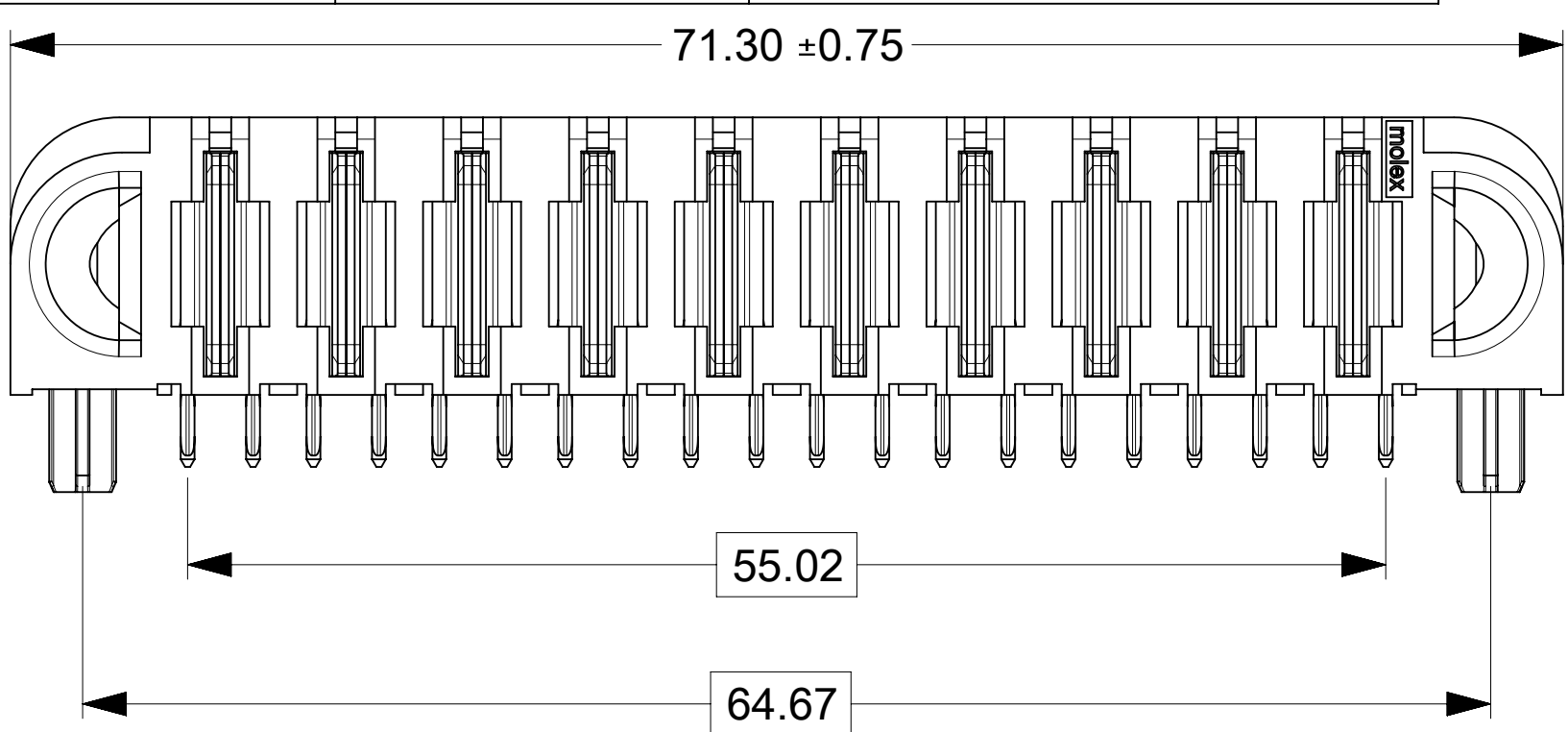

THIS DRAWING CONTAINS INFORMATION THAT IS PROPRIETARY TO MOLEX ELECTRONIC TECHNOLOGIES, LLC AND SHOULD NOT BE USED WITHOUT WRITTEN PERMISSION			
DIMENSION UNITS	SCALE	CURRENT REV DESC:	
mm	3:1		
GENERAL TOLERANCES (UNLESS SPECIFIED)			
ANGULAR TOL	±	°	
4 PLACES	±		
3 PLACES	±		
2 PLACES	±	0.25	
1 PLACE	±	0.3	
0 PLACES	±		
DRAFT WHERE APPLICABLE MUST REMAIN WITHIN DIMENSIONS		THIRD ANGLE PROJECTION	DRAWING SERIES
			D-SIZE 219562
		MATERIAL NUMBER	CUSTOMER
		SEE CHART	
		EC NO: 745288	
		DRWN: LZABJANOVSKI	2023/03/09
		CHK'D: JAYK1	2023/04/10
		APPR: JAYK1	2023/04/10
		INITIAL REVISION:	
		DRWN: LZABJANOVSKI	2022/03/14
		APPR: BPISZCZOR	2022/08/04
		DOCUMENT NUMBER	DOC TYPE DOC PART REVISION
		2195629000-SD	PSD 000 A1
		MATERIAL NUMBER	CUSTOMER
		SEE CHART	
		SHEET NUMBER	2 OF 2

DOCUMENT STATUS	P1	RELEASE DATE	2023/04/11	17:04:40
-----------------	----	--------------	------------	----------

molex

GUARDIAN HD RA PLUG POWER ONLY PF

PRODUCT CUSTOMER DRAWING